

# **Technical Report for Research Unit FOR-1511**

Protection and Control Systems for Reliable  
and Secure Operation of Electrical  
Transmission Systems

June 2013

The work on this report within the Research Group FOR 1511 "Protection and Control Systems for Reliable and Secure Operation of Electrical Transmission Systems" has been supported by Deutsche Forschungsgemeinschaft (DFG)

Speaker: Univ.-Prof. Dr.-Ing. habil. Christian Rehtanz  
Address: Technische Universität Dortmund  
Institut für Energiesysteme, Energieeffizienz und Energiewirtschaft (*ie<sup>3</sup>*)  
D-44227 Dortmund

# Contents

<b>Editor's introduction</b> . . . . .	<b>3</b>
<b>Subproject I</b> . . . . .	<b>7</b>
<b>Object Models for Co-Simulating IEC 61850 based Power and Communication Networks</b> . . . . .	<b>8</b>
<i>Hanno Georg</i>	
<b>Subproject II</b> . . . . .	<b>15</b>
<b>Modelling and Evaluation of Dynamical Behaviour of Multi-Machine-Systems and Design Ideas for new Protection Systems</b> . . . . .	<b>16</b>
<i>Stefan Habel</i>	
<b>Subproject III</b> . . . . .	<b>21</b>
<b>Alternative Approaches for Real-time Congestion Management</b> . . . . .	<b>22</b>
<i>Sven Christian Müller</i>	
<b>Subproject IV</b> . . . . .	<b>30</b>
<b>System Protection against Overload Cascades</b> . . . . .	<b>31</b>
<i>Andreas Kubis</i>	
<b>Subproject V</b> . . . . .	<b>37</b>
<b>Using Wide Area Monitoring as an Approach for Stability Assessment in Electrical Transportation Networks</b> . . . . .	<b>38</b>
<i>Sebastian Brato</i>	

<b>Meta-modelling the energy simulation by Design of Experiments . . .</b>	<b>43</b>
<i>Dirk Surmann, Sebastian Krey</i>	
<b>Subproject VI . . . . .</b>	<b>52</b>
<b>Performance Evaluation of Communication Networks for Cyber Physical Energy Systems . . . . .</b>	<b>53</b>
<i>Nils Dorsch</i>	
<b>Evaluation of the Virtualized Execution Platform . . . . .</b>	<b>60</b>
<i>Boguslaw Jablkowski</i>	

# Editor's introduction

Complementing the work documented in the list of publications below, the following reports present interim results of research unit FOR1511 "Protection and Control Systems for Reliable and Secure Operation of Electrical Transmission Systems". For a recent list of publications the reader is referred to the website [www.for1511.tu-dortmund.de](http://www.for1511.tu-dortmund.de).

## List of Publications

S. C. Müller, M. Osthues, C. Rekowski, U. Häger, and C. Rehtanz: Techno-Economic Evaluation of Corrective Actions for Efficient Attainment of (N-1)-Security in Operation and Planning, accepted for presentation at the 2013 IEEE PES General Meeting, Vancouver, Canada, Jul. 2013

S. C. Müller; A. Kubis, S. Brato, C. Rehtanz, J. Götze: Schutz- und Leitsysteme zur zuverlässigen und sicheren elektrischen Energieübertragung – Interdisziplinäre Forschung im Rahmen der DFG-Forschergruppe 1511, ETG Mitglie­derinformation Nr.2, Juni 2013

S. C. Müller: The impact of ICT on WAMPAC applications – a new level of detail needed in the development of applications and in dynamic security assessment, Electric Power Control Center Workshop (EPCC), Bedford Springs, U.S., June 2013

S. C. Müller, U. Häger, H. Georg, S. Lehnhoff, C. Rehtanz: Integrated Coordination of AC Power Flow Controllers and HVDC Transmission by a Multi-Agent System, IEEE MSCPES 2013, Berkeley, U.S., May 2013

U. Häger: Agent-based real-time Coordination of Power Flow Controllers, Vortrag im Rahmen des International Workshop on Smart Grid Research: Smart Grid Technologies for Green and Efficient Power, Changsha, China, May 2013

S. C. Müller: Wide-Area Monitoring Protection and Control: Simulation Environments and Development of Selected WAMPAC Applications, Vortrag im Rahmen des International Workshop on Smart Grid Research: Smart Grid Technologies for Green and Efficient Power, Changsha, China, May 2013

H. Georg, N. Dorsch, M. Putzke, C. Wietfeld: Performance Evaluation of Time-critical Communication Networks for Smart Grids based on IEC 61850, IEEE INFOCOM '2013 Workshop on Communications and Control for Smart EnergySystems (INFOCOM '2013 CCSES), Turin, Italy, Apr 2013.

S. C. Müller, U. Häger, H. Georg, S. Lehnhoff, C. Rehtanz, C. Wietfeld, H. Wedde and T. Zimmermann: Einbindung von intelligenten Entscheidungsverfahren in die dynamische Simulation von elektrischen Energiesystemen, Springer Informatik-Spektrum 2013, Vol. 36, Issue 1, pp. 6-16

C. Spieker, S. C. Müller, J. Schwippe, C. Rehtanz: Kombinierte Netz- und Marktmodellierung zur Analyse von Engpassmanagementverfahren, IEEE PESS 2013, Bielefeld, Germany, Jan. 2013

V. Franz, A. Kubis, C. Rehtanz: Modellierung eines witterungsabhängigen Überlastschutzes auf Basis eines thermischen Freileitungsmodells, IEEE PESS 2013, Bielefeld, Germany, Jan. 2013 – ausgezeichnet mit einem Best Paper Award.

S. Fischer, A. Kubis, M. Greve, C. Rehtanz: Macro-Economic Calculation of the Value of Lost Load and the Costs per Hour of Blackouts in Germany, IEEE PESS 2013, Bielefeld, Germany, Jan. 2013.

U. Häger: Agent-Based Real-Time Coordination of Power Flow Controllers, Dissertation, TU Dortmund, ie<sup>3</sup>, Dec. 2012 - mit Auszeichnung

H. Georg, S. C. Müller, C. Rehtanz and C. Wietfeld: A HLA Based Simulator Architecture for Co-simulating ICT Based Power System Control and Protection Systems, 3rd IEEE International Conference on Smart Grid Communications (SmartGridComm 2012), Tainan City, Taiwan, Nov 2012 - ausgezeichnet mit dem Best Paper Award

C. Müller, M. Putzke and C. Wietfeld: Traffic Engineering Analysis of Smart Grid Services in Cellular Networks, 3rd IEEE International Conference on Smart

Grid Communications (SmartGridComm 2012), Tainan City, Taiwan, Nov 2012

B. Jablkowski and O. Spinczyk: Continuous performance analysis of fault-tolerant virtual machines, Proceedings of the 1st GI Workshop on Software-Based Methods for Robust Embedded Systems (SOBRES '12), Lecture Notes in Informatics. German Society of Informatics, Sept. 2012. to appear.

S. C. Müller, A. Kubis, S. Brato, C. Rehtanz, J. Götze: Innovative Schutz- und Leitsysteme zur zuverlässigen und sicheren elektrischen Energieübertragung, VDE Kongress 2012, Stuttgart, Germany, Nov. 2012

S. C. Müller: Real-Time Congestion Management, Vortrag im Rahmen des ie<sup>3</sup>-PhD-Seminars, Dortmund, Germany, 09.10.2012

S. C. Müller, A. Kubis, S. Brato, U. Häger, C. Rehtanz and J. Götze: New Applications for Wide-Area Monitoring, Protection and Control, 3rd IEEE PES Innovative Smart Grid Technologies (ISGT) Europe Conference, Berlin, Germany, Oct 2012

S. C. Müller, H. Georg, C. Rehtanz and C. Wietfeld: Hybrid simulation of power systems and ICT for real-time applications, 3rd IEEE PES Innovative Smart Grid Technologies (ISGT) Europe Conference, Berlin, Germany, Oct 2012

S. C. Müller: Einbindung von intelligenten Entscheidungsverfahren in die dynamische Simulation von elektrischen Energiesystemen, Vortrag im Rahmen der D-A-CH Konferenz Energieinformatik 2012, Oldenburg, Germany, 05.07.2012

S. Habel, D. Kamenschikow, S. Kulig: Subsynchronous Resonances Caused by Serial Compensated Overhead Lines in a Transmission Network and their Effect on Turbo-Generators, EPNC 2012, Pula, Croatia, Jun 2012

S. C. Müller, U. Häger, C. Rehtanz and H. F. Wedde: Application of Self-Organizing Systems in Power Systems Control, in: David Hutchison, Takeo Kanade, Josef Kittler, Jon M. Kleinberg, Friedemann Mattern, John C. Mitchell et al. (Hg.): Lecture Notes in Computer Science. Berlin, Heidelberg: Springer Berlin Heidelberg, S. 320-334

S. C. Müller: Hybrid Simulator for Energy and ICT Systems / Decentralized Coordination of Power Flow Controllers for Increasing Transmission Capacity and Security, Vortrag im CORESO Coordination Service Center, Brussels, Belgium, 12.02.2012

U. Häger, S. Lehnhoff and C. Rehtanz: Analysis of the Robustness of a Distributed Coordination System for Power Flow Controllers, 17th international Power Systems Computation Conference (PSCC), Stockholm, Sweden, 2011  
- ausgezeichnet mit VDE/ETG-Literaturpreis 2012

S. Lehnhoff; U. Hager, T. Zimmermann and C. Rehtanz: Autonomous distributed coordination of fast power flow controllers in transmission networks, 2011 2nd IEEE PES International Conference and Exhibition on Innovative Smart Grid Technologies. Manchester, UK, Dec. 2011



# Subproject I

## Hybrid Simulator for Energy and ICT-Systems

Christian Rehtanz

Christian Wietfeld

# Object Models for Co-Simulating IEC 61850 based Power and Communication Networks

Hanno Georg  
Lehrstuhl für Kommunikationsnetze  
Technische Universität Dortmund  
hanno.georg@tu-dortmund.de

This technical report introduces an object modeling approach for realizing a co-simulation for power and communication networks based on the IEC 61850, on basis of the Hybrid Simulator Architecture introduced in [2]. For this, at first the requirements of IEC 61850 communication services applied for the co-simulation are introduced. Next, an object model for storing the simulation variables and interactions for triggering events between the sub-simulators are highlighted and mapped to the IEC 61850 communication services. Afterwards, the so called Federate Object Model (FOM) applied for the IEEE Std. 1516 based co-simulation is given. Finally, this report closes with a conclusion and an outlook on future work. The presented object model is part of the research activity in DFG research unit 1511.

## 1 Motivation and Problem Statement

Future *Wide Area Monitoring and Protection Systems* (WAMPAC) strongly depend on the underlying communication networks, which are necessary for exchanging measurement reports and control information over wide area networks. Thus, for evaluating the real-time capability, it is essential to take into account the transmission delays arising within the communication network and - especially in case of modeling the impact of protection systems - to enable the power system simulation to use this delays in order to determine whether a successful application of protection systems to recover the power systems steady state is possible. The usual way of evaluating the impact of new

WAMPAC applications in different scenarios is modeling and simulating the corresponding networks and approaches. Considering future power systems in terms of *Cyber Physical Energy Systems* (CPES), additional challenges are posed, as these networks consist of two components, the power system itself and an overlaying communication network applied for transmitting monitoring and control information. Additionally, as both power and communication network are simulated using their own specialized simulator, modeling the mutual effects of both networks can only be achieved by either re-implementing the communication models in a power system simulator (or vice versa) or combining both simulators using time and object synchronization. Using the first approach, an advantage is clearly the fact, that no additional synchronization is necessary. Nevertheless, each model needs to be adapted to the new time modeling approach, so the implementation effort would be enormous. In contrast, realizing a combined simulation minimizes the implementation effort on the models and existing platforms can be carried on. Yet the simulator needs to be adapted in order to support time synchronization and a distributed simulation model. Here, standardized solutions as the IEEE Std. 1516 - High Level Architecture (HLA) exist and facilitate the process of development by providing frameworks for realizing time and object management. In this technical report, the object management applied for the co-simulation as introduced in [2], [7], [6] will be introduced and detailed in relation to the IEC 61850 communication services. This technical report is structured as follows: First, section 2 briefly introduces the communication services of IEC 61850 as applied for the communication within the co-simulation. Next, section 3 presents interactions for modeling the events between simulators and attributes of the object model for storing the simulation variables. Finally, this report closes with a conclusion and an outlook on future work in section 4.

## 2 IEC 61850 based Communication services

The IEC 61850 is an international standard for the design of electrical Substation Automation Systems (SAS) and has been developed by the International Electrotechnical Commission (IEC) Technical Committee 57 (TC57). It has been approved as a possible candidate for emerging smart grid communication [3]. Additionally, the ongoing standardization is extending the usage of IEC 61850 for controlling e.g. inter substation communication, wind turbines, distributed energy resources, etc. Currently, the standard consists of 10 main parts defining a substation configuration language, policies for data modeling, communication services, etc. Communication services in IEC 61850 are modeled by four major services (c.p. figure 1), which can be divided into the highly, time-critical lower level services *Sampled Values* (SV) and *Generic Object Oriented Substation Event* (GOOSE) on the one hand and the reliable, upper level services *Manufacturing Messaging Specification* (MMS) and *Simple Network Time Protocol* (SNTP) on the other hand. While lower level services encapsulates their messages directly into the Ethernet frame, the upper level services are making use of TCP resp. UDP connections for transmitting their messages.

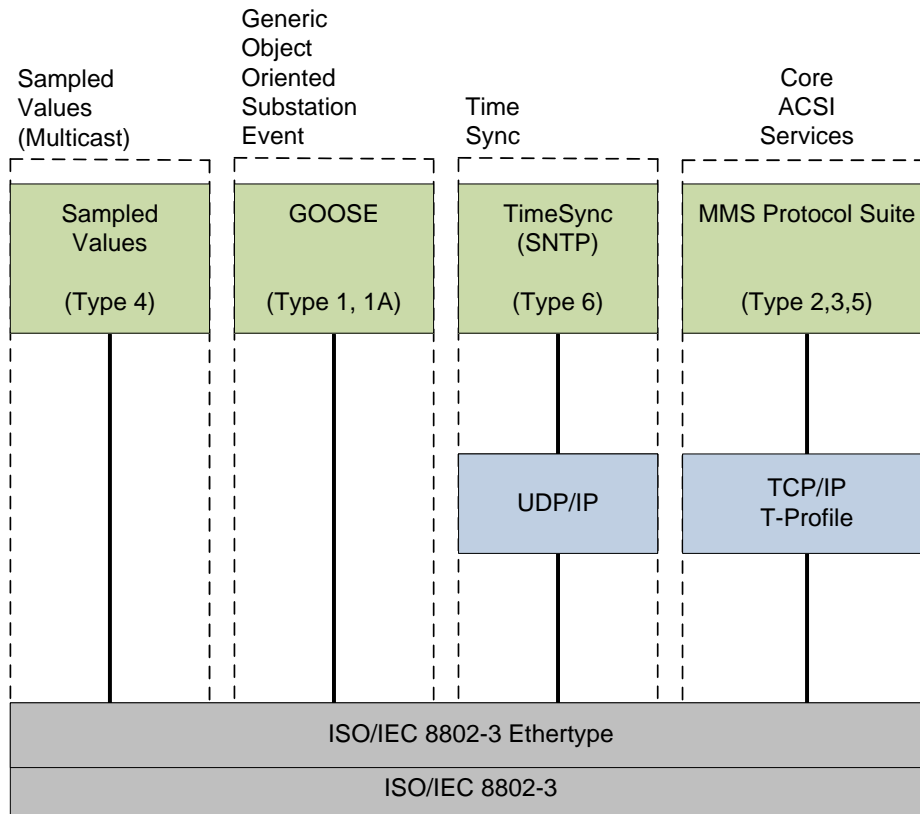

Figure 1: Common Communication Services in IEC61850

Considering the application of the IEC 61850 for WAMPAC applications, the major part of the object model applied for the co-simulation lies in the MMS communication service, which will be taken into account more detailed in the following:

The Manufacturing Messaging Specification (MMS) is used for reliable communication between components on substation and wide area level and offers a wide range of functions. For mapping the individual functions to the simulation model, the services of MMS have been divided into three major parts, which will be detailed in the following:

### MMS Read Service

The read service is used for requesting a specific value from the destination node. For this, the service is divided into a request sent to the corresponding destination node carrying the requested data attributes and a response from the destination node transferring the requested data attributes together with the current values. Actions concerning read requests are local and limited to the object model of the destination node and simulation variables stored for this node.

## **MMS Write Service**

The write service is applied for sending control information to a destination node. In contrary to the read service, the write service is not limited to the destination nodes local object model, but instead applies the GOOSE service as control operations, e.g. changing a switch setting, are translated to GOOSE and transmitted to the corresponding device at bay level.

## **MMS Report Service**

Like the read service, the report service is limited to the local object model. However, this service triggers an additional reporting service at the destination node, generating reports carrying the requested data attributes with a specified transmission interval.

# **3 Object Models and Interaction**

This section introduces the object model for storing simulation variables and interactions referring to the three MMS communication services as described in section 2. As both interactions and data objects are used for setting up the HLA based co-simulation environment, the comprehensive description will be stored in the HLA Federate Object Model (FOM) [1] as applied for the co-simulation in [2]. This section starts with a description of the interactions between the simulators applied for the co-simulation and continues with the object model, which is based on the data model provided by IEC 61850 [4].

## **3.1 Interactions**

The interactions of the simulator applied for the co-simulation can be mapped to the three MMS services as defined in section 2 and are given in detail in Figure 2.

### **Read service**

The MMS read service will be modeled using 2 interactions between the communication simulator and the abstract Substation Data Processing Unit (SSDPU) [2]. The first *client\_request* interaction class indicates the request itself, which consists of an address for both source and destination node along with the corresponding data attributes requested from the destination node. This event will usually be triggered by the SSDPU itself to start the read service at the corresponding source node. The second *client\_response* interaction class indicates the response of a previous request and contains the requested attribute values in addition. Compared to the previous event, this will

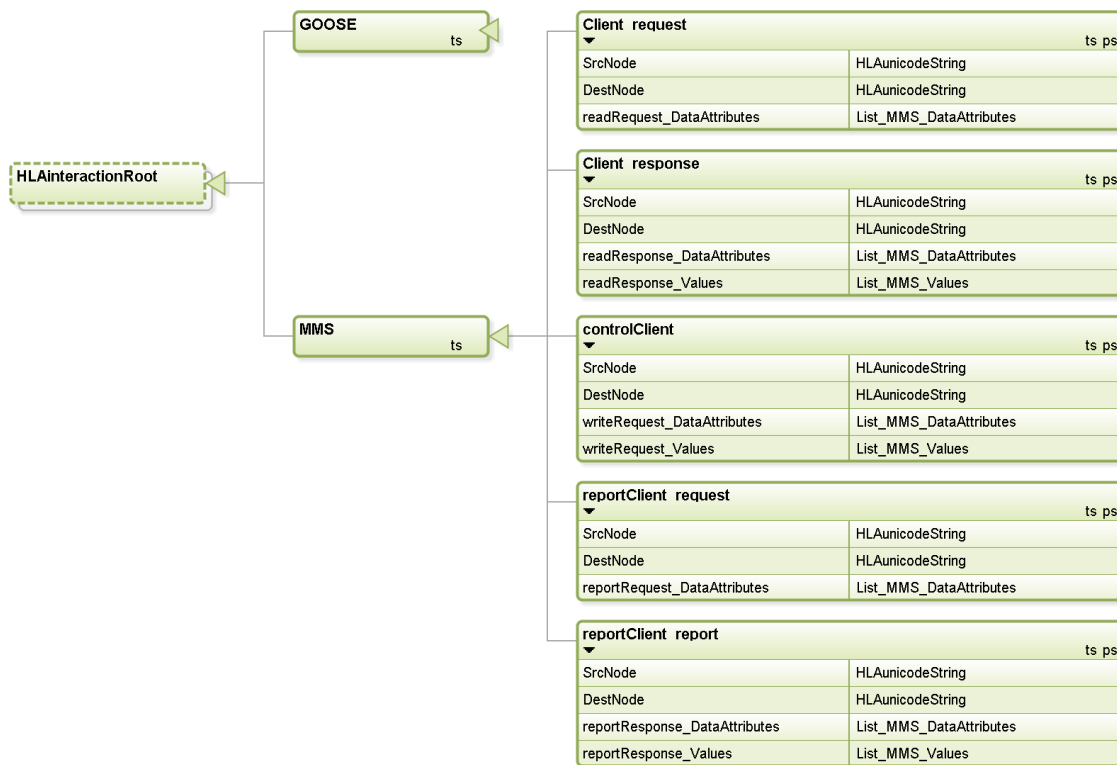

Figure 2: Interaction Classes for accessing IEC 61850 MMS services

usually trigger the SSDPU passing the requested data values back to a control algorithm implemented within the SSDPU.

### Write service

The MMS write service is triggered using the interaction class *ControlClient*. In contrast to the read request, this service is modeled using a single interaction class and transmits both data attributes and values at once. At the destination node, both data attribute and values are extracted from the message and handed over to the GOOSE model, which in turn triggers a GOOSE transmission to e.g. the nearby protection device at bay level nearby.

### Report service

The MMS report service, like the read service, is divided into two separate interactions. The first interaction class *reportClient\_request* indicates the subscription request of a source node. This node attaches both source and destination address, along with the

data attributes the node wants to subscribe and transmits this information to the destination node. The reportClient request will usually be triggered by the SSDPU to start a subscription of the corresponding destination node. After successfully subscribing to a given list of data attributes, an additional service is triggered at the destination node side within the communication network simulator. Throughout the following subscription period this service, generates reports with a specified inter arrival time, transmitting the corresponding attribute values to the source node. The second interaction *reportClient\_response* is triggered and handed over to the SSDPU, whenever a report reaches the source node, which initiated the subscription.

### 3.2 Data model

The IEC 61850 based data model for storing the simulation variables is given in Figure 3. For accessing the data attributes, IEC 61850 defines a virtual model for the *Intelligent Electrical Devices (IED)*. This model defines an IED as a set of *Logical Devices (LD)* and *Logical Nodes (LN)*. A complete list of LDs and LNs can be found within the IEC Std. 61850-7-4 [5]. The mapping of the virtual data model as applied within the co-simulation can be found in Figure 3

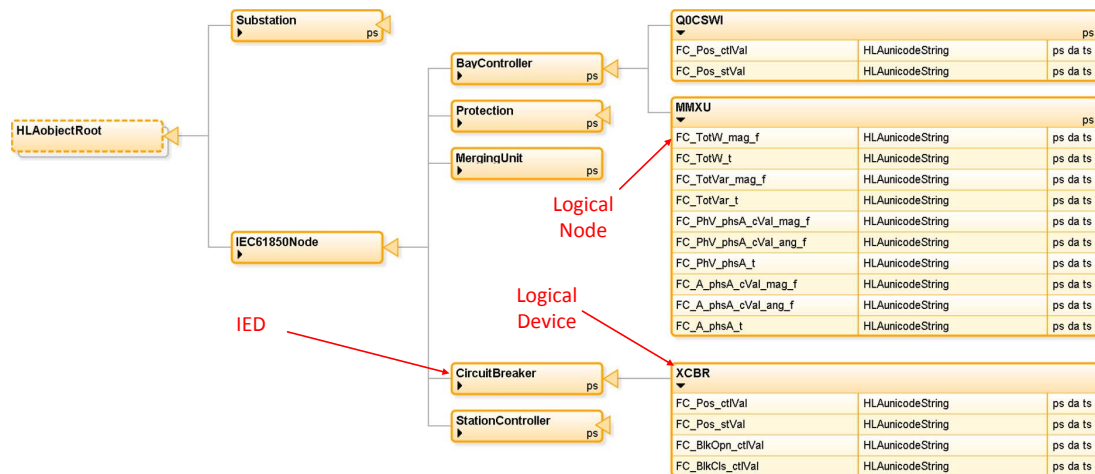

Figure 3: Object Classes for accessing IEC 61850 MMS Data Attributes

## 4 Conclusion and Outlook

In this technical report an object model applied for the co-simulation of IEC 61850 based power and communication networks is introduced, as suggested in [2]. This object model is capable of mapping the inter simulation events and variables between the power

and communication network simulator and is based on the IEC 61850 data model. In the communication network simulator, this model is used for generating corresponding network traffic along with transporting control and measurement information in the co-simulation. The object model provided in the current version, contains various object classes for protection devices, the circuit breaker for performing switching operations and classes for accessing measurement values at bay and station controller. Additionally, interactions between power and communication network simulator are available providing different kind of MMS based communication services (Read, Write and Report). Various proof-of-concept communication flows have been analyzed to assure the correct behavior of the object and interaction model. As next steps, a reference scenario, in which the impact of the end-to-end communication delay can be evaluated will be set up and analyzed using various communication technologies and protocols.

## References

- [1] IEEE Standard for Modeling and Simulation (M&S) High Level Architecture (HLA)–Object Model Template (OMT) Specification, 18 2010.
- [2] Hanno Georg, Sven Christian Müller, Christian Rehtanz, and Christian Wietfeld. A HLA Based Simulator Architecture for Co-simulating ICT Based Power System Control and Protection Systems. In *3rd IEEE International Conference on Smart Grid Communications (SmartGridComm 2012)*, Tainan City, Taiwan, November 2012.
- [3] V.C. Gungor, D. Sahin, T. Kocak, S. Ergut, C. Buccella, C. Cecati, and G.P. Hancke. Smart grid technologies: Communication technologies and standards. *Industrial Informatics, IEEE Transactions on*, 7(4):529–539, 2011.
- [4] IEC TC57. Communication networks and systems for power utility automation - Part 7-3: Basic communication structure for substation and feeder equipment - Common data classes (IEC 61850-7-3:2003), 08 2010.
- [5] IEC TC57. Communication networks and systems for power utility automation - Part 7-4: Basic communication structure - Compatible logical node classes and data object classes, 03 2010.
- [6] Sven C. Müller, Hanno Georg, Christian Rehtanz, and Christian Wietfeld. Hybrid simulation of power systems and ICT for real-time applications. In *3rd IEEE PES Innovative Smart Grid Technologies (ISGT) Europe Conference*, Berlin, Germany, October 2012.
- [7] Sven C. Müller, Ulf Häger, Hanno Georg, Sebastian Lehnhoff, Christian Rehtanz, Christian Wietfeld, Horst F. Wedde, and Thomas Zimmermann. Einbindung von intelligenten Entscheidungsverfahren in die dynamische Simulation von elektrischen Energiesystemen. *Informatik Spektrum*, 36(1):6–16, 2013.



## Subproject II

# New Concepts for Power Plant Protection Using Wide Area Information

Stefan Kulig

# Modelling and Evaluation of Dynamical Behaviour of Multi-Machine-Systems and Design Ideas for new Protection Systems

Stefan Habel

Lehrstuhl für Elektrische Antriebe und Mechatronik

Technische Universität Dortmund

stefan.habel@tu-dortmund.de

This report gives a brief overview about the simulations that have been done concerning multi-machine-dynamics. The results show that control-systems, like exciter and turbine governor, can be generalized in order to limit the necessary simulation time.

For upcoming analyses statistical methods that may help to get further information about multi-machine-dynamics are presented and shown exemplarily. Furthermore, an outlook illustrates some ideas of improvements for today's protection systems.

## 1 Introduction

The near-term goal of the project is the characterization of multi-machine-dynamics (mmd), in the long term this shall lead to new protection and control-systems that make use of mms-characterization. Until now, we were focussing on the analysis of the dynamical behaviour of multi-machine-systems only for non-controlled generators. Therefore, to analyse mms under "realistic" circumstances control-systems like excitation- and turbine-control have to be taken into account. But on the one hand we need to simulate the control-systems as detailed as possible but on the other hand it is necessary to obtain results as universal as possible. This interplay of the two aspects leads to the necessity



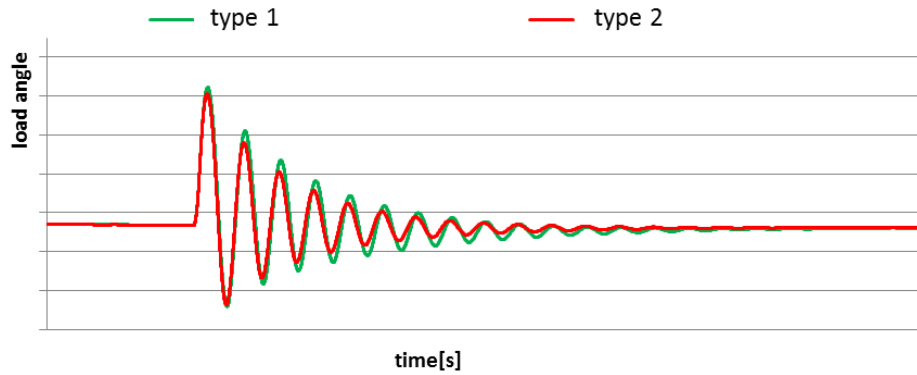

Figure 2: Time curves of the load angle of two different controllers after a short-circuit

Yet studies have only been done for this specific system, therefore further studies with more than one generator should be made but we expect it to match the presented results.

### 3 Statistical methods for analysing electro-mechanical transients

To analyse the more complex transients in "real" grids, we use statistical methods to get a better and more general picture of the main multi-machine-dependencies when varying the structure of the grid.

The simplest approach would be the calculation of the maximum or the minimum of a signal (e.g. the load angle after a short-circuit) over, for example, the length of a transmission line (s. fig. 3). Another, even more classical method is the calculation of a

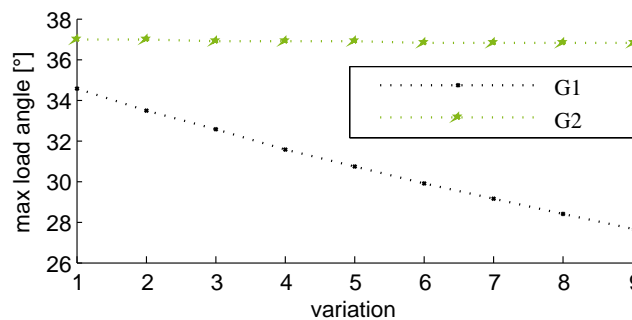

Figure 3: Maximum of the load angle of two generators over the variation of one parameter after a short-circuit

linear Pearson correlation coefficient [1] to measure the similarity between two signals.

$$r_{xy} = \frac{\sum_{i=1}^n (x_i - \bar{x})(y_i - \bar{y})}{\sqrt{\sum_{i=1}^n (x_i - \bar{x})^2 \cdot \sum_{i=1}^n (y_i - \bar{y})^2}} \quad (1)$$

The main problem that occurs is the fact, that this correlation may not be linear. In fact, we could calculate different coefficients that take the non-linearity into account, but it will still result in a single value.

A graphical method are scatter plots, in which two streams of data (e.g. time curves) are plotted against each other (s. fig. 4) [4].

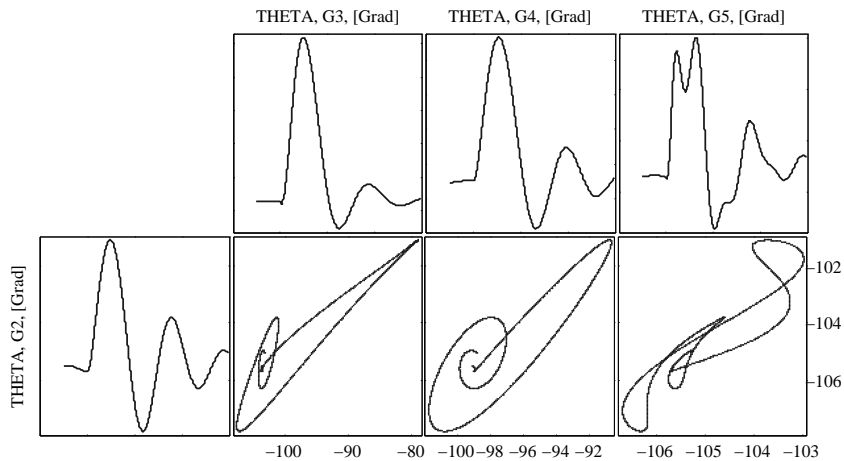

Figure 4: Scatter plots for the load angle of four generators in a electrical grid after a short-circuit

Looking only at the time curves probably gives the feeling that the signals are almost identical, but comparing scatter plots we can find obvious differences. Upcoming studies have to show whether scatter plots help to characterize the behaviour of multi-machine-systems or are even a tool to visualize online the dynamical behaviour of an electrical system.

## 4 Ideas for improving protection systems

Studying state-of-the-art protection lets us conclude that current systems are working well for today's demands but the upcoming changes in the electrical power generation and transportation will probably require improved (e.g. more intelligent) or even new approaches of protection systems. In this project we will focus on improving the out-of-step (oos) protection systems [2] as well as the protection against sub-synchronous

resonances that are not appearing at all in Germany yet but are going to be in focus of interest in the near future [3].

The main factor that leads to an out-of-step condition of a generator is an unbalance of energy. For example during a short-circuit the generator cannot transfer enough energy into the grid due to the significantly lowered voltage at its node. The excess energy will then be converted into rotational energy of the rotor and therefore increase its (angular) velocity.

$$E_{rot} = \frac{1}{2} I \omega^2 \quad (2)$$

(with I: moment of inertia ;  $\omega$ : angular velocity)

A possible solution could be the use of big resistances to transform the electrical energy into thermal energy to limit the increase of the load angle. The dimensioning of the resistance and the triggering of the system are of course open questions that have to be studied and answered.

If we assume that durability of the resistance will be lowered with every application we need to use it as seldom as possible. Wide area information may help to detect and decide whether it is useful or not needed. Knowledge about multi-machine-dynamics may help solving this task. This work is part of DFG FOR1511.

## References

- [1] Hartung, Joachim. *Statistik*. Oldenbourg Verlag, 1999.
- [2] J. Berdy. Out-Of-Step Protection For Generators.
- [3] Krebs, R.; Buchholz, B.M.; Styczynski Z. A.; Rudion K.; Heyde C.;. Vision 2020 - Security of the network operation today and in the future. German experiences, 2008.
- [4] NIST. Scatter plots. <http://www.itl.nist.gov/div898/handbook/eda/section3/eda33q.htm>, visited on 04.23.2013.

## Subproject III

# Decentralized Coordination of Power Flow Controllers for Increasing Security and Efficiency of Transmission System Operation

Christian Rehtanz

Horst Wedde

# Alternative approaches for real-time congestion management

Sven Christian Müller

Institut für Energiesysteme, Energieeffizienz und Energiewirtschaft  
Technische Universität Dortmund  
svenchristian.mueller@tu-dortmund.de

This technical report discusses alternative approaches for real-time congestion management. First, congestion management in general and influential factors on power flows are briefly outlined. Then, the different time horizons of security management in power system operation are highlighted and four different approaches for decision making in real-time congestion management are examined. Comparison and development of real-time congestion management solutions is part of the research activity in DFG research unit 1511 and DFG RE 2930/11-1.

## 1 Introduction

In a liberalized electricity market, congestion management belongs to the key tasks of Transmission System Operators (TSOs) to contribute to a both efficient and secure transmission system operation. According to [9], congestion can be defined as follows:

*Congestion occurs whenever the transmission network is unable to accommodate all the desired transactions due to the violation of one or more constraints for the resulting state under both the base case and a set of specified contingencies.*

Aforesaid constraints can include limits on voltage magnitude, voltage angle, currents, active and reactive power feed-in and consumption, transformer tap settings, control speed (e.g., maximum power gradients for generation facilities), etc. The selection of a base case is usually based on forecasts (e.g., with respect to feed-in by renewable energy sources (RES) and load). Depending on applicable policies and grid codes, a set of



contingencies - such as outages of equipment in the transmission system or generation facilities - is defined (e.g., [10]). This set may include all N-1 cases (loss of any piece of all N pieces of equipment in the network model) or a risk-based selection of contingencies. Congestion management needs to ensure that in none of the selected cases violations of the constraints occur, whereas temporary excess might be acceptable [10].

## 2 Influential factors on power flows

A major concern in congestion management is to keep power flows on network branches within operational limits as the European transmission network does not provide the transmission capacity that a liberalized European electricity market demands and overloads of branches may lead to cascading line trippings thereby increasing the risk of blackouts. Fig. 1 gives an overview of the main influential factors on power flows.

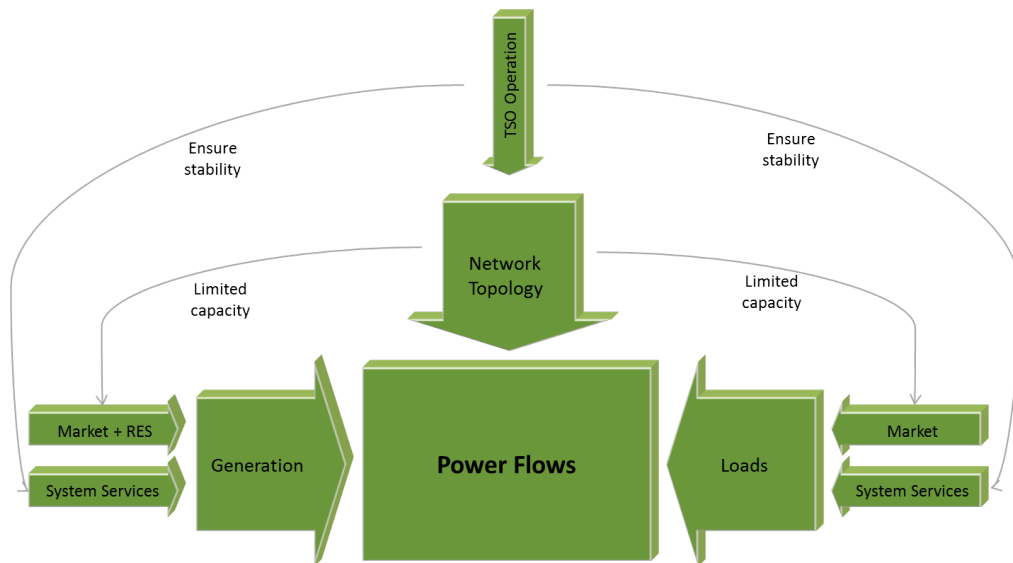

Figure 1: Influential factors on power flows

The pattern of power flows result directly from the network topology and the configuration of generation and load. The network topology is under control of the TSOs and certain topological actions can be taken to influence the power flow pattern. These actions include rearranging the configuration of AC transmission lines (e.g., by use of couplings or disconnection of lines) or use of controllable network equipment such as Phase Shifting Transformers (PSTs), Flexible AC Transmission Systems (FACTS) devices or High-Voltage Direct Current (HVDC) transmission lines.

Even when exploiting all topological measures, the capacity of the transmission system is limited. In the case of the European transmission system, these limits on power flows restrict the electricity markets to supply the loads with the generation facilities offering their feed-in at the lowest cost. Due to the historical development of the transmission system over time, particularly the interconnection between several TSOs and different countries have limited capacity. Integration of several national electricity markets is undertaken by use of different congestion management methods (e.g., flow-based market coupling) that restrict the set of allowable market clearing results (in particular, the configuration of generation) to those which do not violate the limits on power flows. As these congestion management methods do not consider all network branches but primarily the interconnectors of market regions, TSOs have to resolve internal congestion in their area of responsibility by either taking topological actions as described above, and - if topological action do not suffice - intervening in the configuration of generation and load that resulted from the market. E.g., two or more power plants in the surrounding of a congested line can be requested to adapt their feed-in in such a way that the power flow on the critical line is reduced (redispatch).

Furthermore, the integration of RES has a significant effect on power flows and congestion management. The high volatility of RES feed-in requires the TSOs to account for this uncertainty (e.g., by increasing security margins of power flow limits) in order to ensure a secure network operation also in case of deviations from forecasted scenarios. Not only the uncertainty but also the volatility itself constitutes a challenge for system operation as power flow patterns change more dynamically and need to be managed by fast reactions. With a higher penetration of RES, the effect of RES on power flows and congestion management will likely become even more significant.

Last, the TSOs are also responsible to ensure frequency stability, voltage stability and angular stability of the system. Ancillary system services are needed for this, which can also have an impact on power flows (e.g., feed-in of reserve energy for balancing system-wide demand and supply).

### **3 Alternative approaches for real-time congestion management**

In this section, a classification of time horizons of security management is presented followed by a discussion of alternative approaches for real-time congestion management.

### 3.1 Time horizons of security management

It is important that congestion management occurs at different time horizons - from day-ahead until real-time operation. Fig. 2 presents one possible classification of time horizons and related actions in the context of security management according to [11]. Above

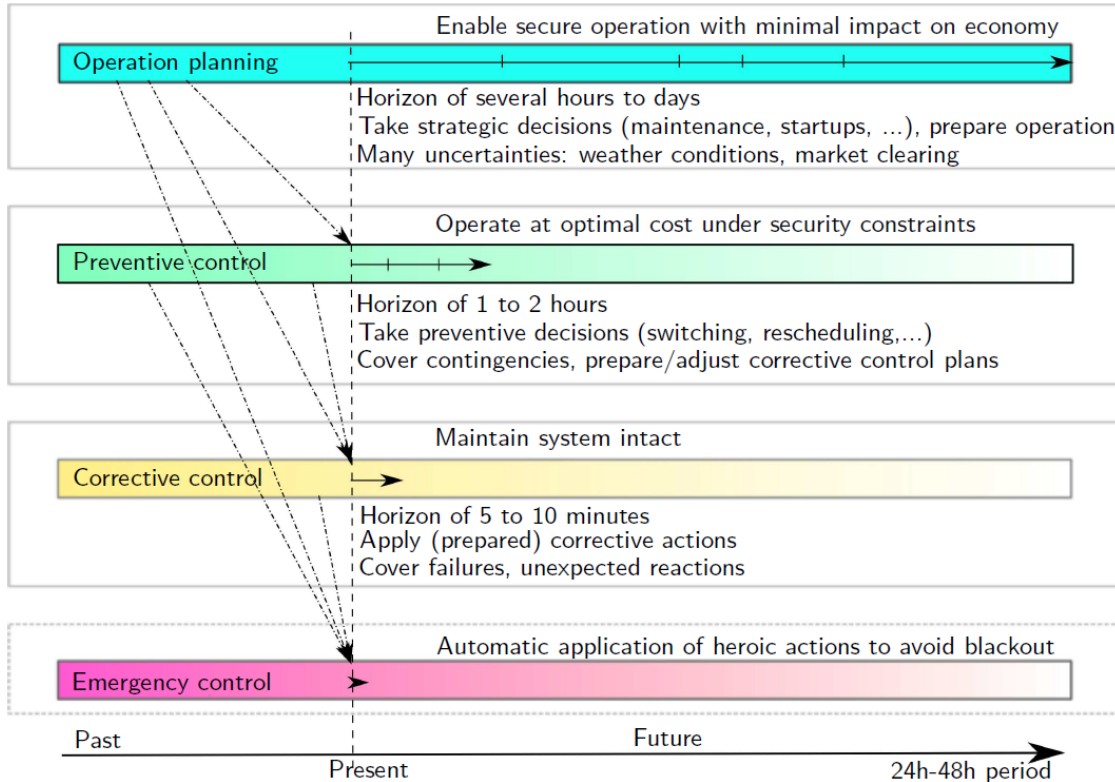

Figure 2: Concurrent security management contexts [11]

mentioned market-based congestion management methods (such as flow-based market coupling) already intervene in the day-ahead market. Closer to real-time, preventive actions are executed with a lead-time of about an hour in case of contingencies or when it already becomes clear that deviations from day-ahead forecasts will occur. At a time horizon of some minutes until milliseconds ahead, corrective and emergency controls take action that maintain the system stability in case of unforeseen contingencies, short-term deviations from forecasts and other unexpected events. In the following we will discuss alternative approaches for measures belonging to the classes of corrective and emergency control according to [11] for avoiding overloads. For these approaches we will use the term real-time congestion management.

## 3.2 Real-time congestion management

In real-time congestion management, short lead-times of milliseconds to few minutes make it eligible to support operators with tools for decision making advice or even automated actions. As discussed in [6] it is desirable to classify situations depending on whether time suffices to take manual actions or whether automated reactions need to intervene. Besides this distinction, it can be differentiated between centralized and decentralized approaches. Fig. 3 presents four alternatives for real-time congestion management including two centralized and two decentralized approaches.

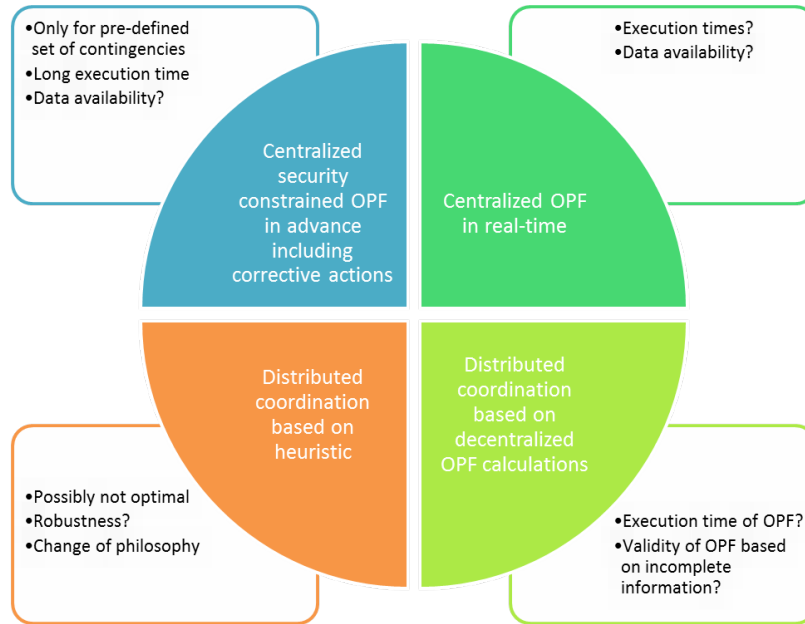

Figure 3: Alternative approaches for real-time congestion management

A state-of-the-art approach in research for identifying appropriate measures for maintaining security of system operation is the use of a global optimization that determines the optimal measures (with a specified objective, e.g., least number of actions or actions at lowest cost) based on a global system model [1]. In a Security Constrained Optimal Power Flow (SCOPF) the system operation can be chosen optimally for both a base case and a set of other cases (e.g., N-1 cases) whereas it can be accounted for the flexibility to react to other cases by taking corrective control actions. This approach offers many advantages, e.g., the determination of optimal and not just feasible measures, as well as the direct inclusion of returning to an N-1-secure operating point. The shortcomings of this approach are its computational intensity (large-scale mixed-integer nonlinear programming (MINLP)) and the dependency on complete and accurate global system data and model. A real-time SCOPF equipped with accurate data would indeed be a very

suitable solution for real-time congestion management. With computation times in the range of several minutes for large-scale systems (compare performance report in [2]), a SCOPF approach must either be reduced (thus losing some accuracy) or it can be computed in advance. The last approach could provide operators or automation systems with a set of actions that has to be executed once a specified contingency (included in the SCOPF) occurs. However, this method needs a predefined set of contingencies and relies on a forecasted system state so it does not cover all potential cases of the future (e.g., N-2 cases or higher).

As the SCOPF's computational intensity derives from its large set of security constraints due to considering potential post-contingency cases, one alternative by using global optimization is the execution of a 'conventional' OPF (only constrained for one case) after the occurrence of a contingency. If operational limits have been violated by the contingency, the OPF can provide optimal countermeasures for the momentary operating point. These countermeasures can then be executed either manually or automatically. This approach also depends on the fast execution of the OPF (which is likely to be more easily capable of close-to-real-time performance) and the availability and accuracy of the underlying global system model. In contrast to the SCOPF approach, the optimal solution does not directly lead the way towards returning to an N-1-secure system state but only to keep the system within operational limits. Returning to N-1-security has to be guided by other tools (e.g., a SCOPF after the contingency) or operators' experience. On the other hand, a real-time 'conventional' OPF could be based on the actual system state after a contingency and does not rely on any forecasts.

The centralized SCOPF and real-time OPF approaches provide optimal control actions that can either be presented to the operator as a suggestion or be executed automatically. For large-scale systems operated by many TSOs like the European transmission system, the availability and accuracy of global system data and models, as well as the time needed for execution for a large-scale MINLP constitute challenges for central optimization approaches. As an alternative, decentralized approaches as discussed in [7] can be applied. E.g., software agents can be installed at the substation level, interact with their environment and perform decentralized decision making based on incomplete (local or regional) information. The decision making could also be based on optimizations, e.g., only taking into account for a part of the entire system. A promising approach using decentralized OPF calculations has been presented in [5] but the approach also faces the challenge of significant computation times [4]. Further, for optimizations based on incomplete information the validity of the results has to be counterchecked. For these reasons, it is worthwhile to investigate also approaches that do not rely on computationally intensive optimizations. In particular, the agent-based coordination of power flow controllers and HVDC based on heuristics has been extensively studied, e.g. in [4], [8], [7]. The approach promises to enable coordinated real-time response of power flow controllers to unforeseen network situations by use of very simple algorithms. Moreover, the system is adaptive to any network situation (even N-2 or higher) and shows a robust performance

for use cases as presented in [3]. As shortcomings, the approach cannot ensure optimality of the reaction and as of today it only covers the control of power flow controllers. It is subject of current research to extended the approach to redispatch. Furthermore, implementation of an automated agent-based control system for power flow controllers would be a significant change from an operational point of view as traditionally these reactions have been decided upon by an operator in the control center.

### 3.3 Conclusion and outlook

Congestion management plays an important role in a liberalized power system and is critical for a both efficient and secure network operation. While market-based congestion management methods aim at avoiding overloads already in the day-ahead market, deviations from forecasts and contingencies can occur. Real-time congestion management applies corrective and emergency controls to ensure a system operation within limits at a time scale of some milliseconds up to few minutes. Four alternative approaches for determining measures for avoiding overloads close to real-time have been presented. Ideally, a real-time SCOPF would be a very suitable solution for real-time congestion management but for large-scale systems it cannot be executed in real-time yet. For this reason, it is worthwhile to further investigate approaches which avoid computationally intensive optimizations and dependency on large data sets and models. The comparisons shows that agent-based approaches as developed in the course of DFG FOR1511 and RE 2930/11-1 can provide significant advantages for enabling real-time response as they only rely on rather simple algorithms. As next steps, the extension of the agent-based coordination system to redispatch will be subject of investigation as well as a validation of the performance of the multi-agent coordination against OPF results.

## References

- [1] F. Capitanescu, J.L Martinez Ramos, P. Panciatici, D. Kirschen, A. Marano Marcolini, L. Platbrood, and L. Wehenkel. State-of-the-art, challenges, and future trends in security constrained optimal power flow. *Electric Power Systems Research*, 81(8):1731–1741, 2011.
- [2] S. Fliscounakis and P. Panciatici. Handling of discrete variables challenges and possible solutions, 2012.
- [3] U. Hager, S. Lehnhoff, and C. Rehtanz. Analysis of the robustness of a distributed coordination system for power flow controllers. In *17th international Power Systems Computation Conference (PSCC)*. IEEE, 2011.

- [4] Ulf Häger. *Agent-based real-time Coordination of Power Flow Controllers*. Sierke Verlag, Göttingen and Niedersachs, 1 edition, 2013.
- [5] Gabriela Hug-Glanzmann and Göran Andersson. Decentralized optimal power flow control for overlapping areas in power systems. *IEEE Transactions on Power Systems*, 24(1):327–336, 2009.
- [6] A. Kubis. System protection against overload cascades. *Technical Report - DFG FOR1511*, 2013.
- [7] Sven C. Müller, Ulf Häger, Christian Rehtanz, and Horst F. Wedde. Application of self-organizing systems in power systems control. In David Hutchison, Takeo Kanade, Josef Kittler, Jon M. Kleinberg, Friedemann Mattern, John C. Mitchell, Moni Naor, Oscar Nierstrasz, C. Pandu Rangan, Bernhard Steffen, Madhu Sudan, Demetri Terzopoulos, Doug Tygar, Moshe Y. Vardi, Gerhard Weikum, Oscar Dieste, Andreas Jedlitschka, and Natalia Juristo, editors, *Lecture Notes in Computer Science*, pages 320–334. Springer Berlin Heidelberg, Berlin and Heidelberg, 2012.
- [8] Sven C. Müller, Andreas Kubis, Sebastian Brato, Ulf Häger, Christian Rehtanz, and Jürgen Götze. New applications for wide-area monitoring, protection and control. In *IEEE PES ISGT Europe 2012*. IEEE, 2012.
- [9] Shu Tao and G. Gross. A congestion-management allocation mechanism for multiple transaction networks. *IEEE Transactions on Power Systems*, 17(3):826–833, 2002.
- [10] UCTE. Operation handbook - policy 3: Operational security, 2004.
- [11] L. Wehenkel. Power systems security management challenges: from operation planning to real-time control, 2012.

## Subproject IV

# System Protection for Transmission Corridors

Christian Rehtanz



# System Protection against Overload Cascades

Andreas Kubis

Institut für Energiesysteme, Energieeffizienz und Energiewirtschaft  
Technische Universität Dortmund  
andreas.kubis@tu-dortmund.de

The research work of DFG FOR1511 TP4 "System Protection for Transmission Corridors" analyzes the behavior of overload cascades in order to develop suitable countermeasures against them or respectively to narrow their impact on power system stability. This paper summarizes the overall approach to detect overloading cascades and to predict its sequence. The detection, estimation and prognosis of overloading cascades is the fundamental indicator to decide which countermeasure could be appropriate against overload cascading.

## 1 Introduction

An Overload Cascade (OC) in an interconnected electric power system is one of the most severe system disturbances. Furthermore, it was the reason for a large number of previous power system blackouts [1], [2]. In this work, we define an overload cascade as the outage of one or more power system elements, respectively transmission lines, due to overload resulting in an overload of the other elements in the system. The overload condition itself is characterized by an over-current  $I_{oc}$ , higher than the maximum rated line current  $I_r$ , but smaller than the minimum excitation current of the line protection equipment  $I_{ex}$ ,

$$I_r < I_{oc} < I_{ex}. \quad (1)$$

The rated current of a transmission line is defined by its thermal behavior and can be calculated under consideration of conductor properties and ambient weather conditions, see [3], [4], [5], [6], [7]. The maximum allowed line operation temperature  $T_{max}$  for aluminum conductors, which are widely used in power transmission systems, is  $80^{\circ}C$ .  $T_{max}$  should not be exceeded in order to maintain line sag and material fatigue requirements as well as to prevent serious damage to the transmission line, its environment and especially human life. In order to take care of these issues, it is import to put the line out of operation, if its temperature exceeds  $T_{max}$ . Doing this may cause significant overloads to remaining transmission lines, which will also need to be taken out-of-operation and thus initializes cascading line tripping. Obviously, cascading line tripping due to overloads will have a negative impact on power system stability.

This paper describes the basic concept of an early warning system against overload cascades as part of a new system protection scheme. The early warning system detects overloading conditions quick and reliable. Further, it will forecast the withstand time of the concerned line and decide whether an overloading condition can be solved by the TSO manually or if automatic actions are required.

## 2 An early warning system against overload cascades

Following, we assume a power system working in n-1 situation. We call this situation "endangered system state". In case another contingency occurs, voltages, currents or the frequency might excess the specified limits, so the system would tend to become unstable. We call this situation "disturbed system state".

Fig. 1 shows the medium line temperature of an exemplary transmission line in an endangered system state. Assuming that this transmission line is an important tie-line between sub-systems, it might happen that another contingency will lead to an abrupt overloading situation. An abrupt increase of current will force the temperature to increase. In this exemplary case, the operating temperature is  $60^{\circ}C$ , what is far below  $T_{max}$ , which is assumed to be  $80^{\circ}C$ . A contingency occurs at  $t = 20$  min and leads to line overloading. After time span  $\Delta t$ , the line temperature has reached the temperature  $T_{max}$ .

$\Delta t$  is defined as the time difference between a current increase due to a contingency and the moment when the line reaches its final temperature. The final temperature, as well as the transient thermal behavior of the overhead line can be calculated based on the thermal overhead line model explained in [5], [6] referring to Eq. 2. Fig. 2 depicts the considered heating and cooling effects,

$$P_l + P_s = P_c + P_r, \quad (2)$$

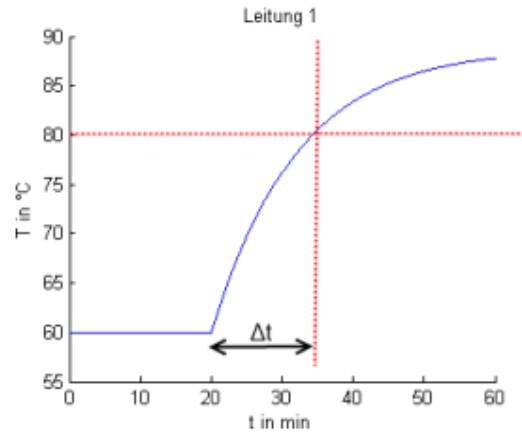

Figure 1: Temperature Increase due to Line Overload

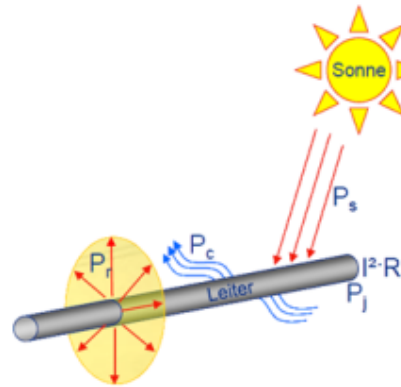

Figure 2: Heating and Cooling Effects on a Transmission Line

where  $P_I$  is current heating including Joule, magnetic and skin effects,  $P_S$  is solar heating,  $P_c$  is convective cooling and  $P_r$  is radiative cooling. Corona heating and evaporative cooling is not considered due to the recommendations made in [5].

Therewith, we can determine  $\Delta t$  under the assumption that the material properties of the line, the ambient weather condition and the line current are known.  $\Delta t$  is used as an estimation for the remaining line operation time, before the overloaded line has to be tripped. This information might help if we want to determine which countermeasure (e.g. load shedding, generation shedding, Power Flow Control with FACTS, etc.) is suitable to endanger the stressed situation. Furthermore, we can define if a countermeasure could be made by the system operator manually or if an automatic action is required. Therefore, we define  $t_{act}$  as minimum time in which a system operator is able to handle the contingency situation manually. If  $\Delta t < t_{act}$ , the operator is not able to react to this

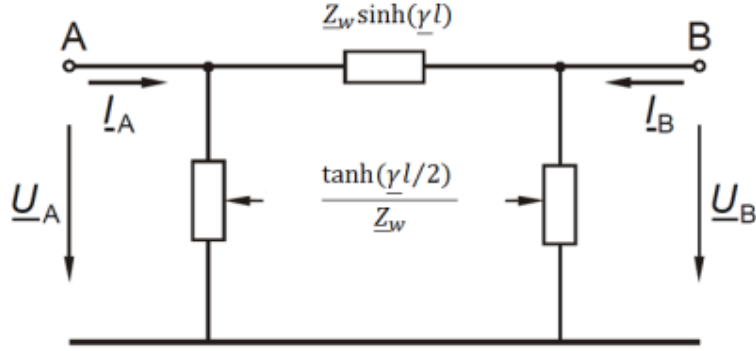

Figure 3: Equivalent  $\pi$ -Circuit of a Lumped Transmission Line Model

contingency in an appropriate time span. So the required action must be made by an automatic system. In the other case, when  $\Delta t > t_{act}$  the operator is able to decide and to apply the countermeasure which appears him to be the best solution. In this case, the system protection scheme can provide him with a list of suitable countermeasures including risk assessment.

In order to prevent false-alarms and to maintain in operation in unforeseen contingencies, it is necessary to use independent measurements. Besides mentioned calculation and prognosis of line temperature based on material constants and weather conditions, a direct and an indirect measurement method should be utilized and applied to vulnerable locations, like couplings and mast suspensions. The usage of these three measurement methods is recommended due to three reasons:

1. The usage of three independent measurement techniques provides high redundancy.
2. Measurements can be used to validate and to adjust the prognosis.
3. Direct and indirect temperature measurements allow the adjustment of elementary line model parameters which are used in the thermal overhead line model for online prognosis.

Direct temperature measurements are performed generally by clamp-on thermal couples [8], whereas indirect measurement methods use variables to estimate the temperature, e.g. measurement of line sag to calculate the temperature. This paper proposes the usage of voltage and current phasor measurements to calculate the medium line temperature indirectly. [9] proposes a method, which is capable of calculating the line temperature in real-time based on PMU measurement data. It has been shown that this method is suitable even under consideration of partial bad-data and different network topologies.

The method is based on the  $\pi$ -equivalent lumped circuit model of a transmission line, see Fig. 3. Knowing voltage  $\underline{U}$  and  $\underline{I}$ , we can calculate  $\underline{Z}$  and  $\underline{Y}$  and thus the line resistance

R, reactance X, conductance G and susceptance B, according to Eq. 3-6, where  $\underline{U}$  and  $\underline{I}$  are the voltages and currents at A and B,  $\underline{Z}_w$  is the characteristic impedance of the line,  $\underline{\gamma}$  is the propagation constant of the line,  $l$  the total line length and  $\underline{z}_1$  and  $\underline{y}_1$  are the positive sequence series impedance and shunt admittance of the line.

$$\underline{U}_A - \underline{Z}_w \sinh(\underline{\gamma}l) \underline{I}_A + \sinh(\underline{\gamma}l/2) \underline{U}_A - \underline{U}_B = 0 \quad (3)$$

$$\underline{I}_A - \tanh(\underline{\gamma}l/2) \underline{U}_A / \underline{Z}_w + \underline{I}_B - \tanh(\underline{\gamma}l/2) \underline{U}_B / \underline{Z}_w = 0 \quad (4)$$

$$\underline{Z}_w = \sqrt{\underline{z}_1 / \underline{y}_1} \quad (5)$$

$$\underline{\gamma} = \sqrt{\underline{z}_1 \underline{y}_1} \quad (6)$$

$$T = (R_{calc} / R_{ref} - 1) / \alpha + T_{ref} \quad (7)$$

It is well known that the line resistance is linearly proportional to the line temperature. So, if the line resistance at a certain temperature is known, which is usually given for  $R_{DC}(20^\circ C)$  as line specification, we can estimate the actual line temperature  $T$  from Eq. 7. Furthermore, we can put the calculated data in relation to loading and weather conditions and use it for adjusting the internal parameters of the thermal overhead line model described above. In this manner, it is possible to adjust the thermal line model according to line corrosion and other aging related effects.

In short, we can use the indirect temperature measurement method to adjust and improve the quality of a thermal overhead line model, which is used to predict the time span from the contingency up to the moment, when the line reaches the critical temperature  $T_{max}$ . The direct temperature measurements are used to see the correct real-time temperature. In the best case, the prognosis will equal the direct measurements.

### 3 Outlook

It has been shown how direct and indirect measurements as well as thermal modeling of line temperature can be used to predict the remaining operation time of an overloaded line. In the next step, the prognosis will be done for more than one line. This multi-prediction will be done in parallel during operation. If an endangered line is spotted, a system protection scheme becomes active according to above definitions. In case more than one line is endangered, it is necessary to determine the most endangered line. This could be done by comparing  $\Delta t$ . This work is part of DFG FOR1511 [10], [11].

## References

- [1] ENTSO-E. Technical Background and Recommendations for Defence Plans in the Continental Europe Synchronous Area. 2011.
- [2] CIGRE Working Group C2.02.24. Defense Plan Against Extreme Contingencies: CIGRE Brochure 316. 2007.
- [3] DIN EN 50182:2001. Leiter für Freileitungen: Leiter aus konzentrisch verseilten runden Drähten.
- [4] VDE. VDE-AR-N-4210-5 - Witterungsabhängiger Freileitungsbetrieb. 2011.
- [5] CIGRE Working Group 22.12. Thermal Behaviour of Overhead Conductors: CIGRE Brochure 207. 2002.
- [6] Transmission and Distribution Committee of the IEEE Power Engineering Society. IEEE Std 738-1993 (Revision of IEEE Std 738-1986) IEEE Standard for Calculating the Current-Temperature Relationship of Bare Overhead Conductors.
- [7] V. Franz, A. Kubis, and C. Rehtanz. Modellierung eines witterungsabhängigen überlastschutzes auf Basis eines thermischen Freileitungsmodells. In *IEEE Power and Energy Student Summit (PESS) 2013, Bielefeld*, 2013.
- [8] CIGRE Working Group B2.36. *Guide for Application of Direct Real-Time Monitoring Systems: CIGRE Brochure 498*. 2012.
- [9] Yan Du and Yuan Liao. Online estimation of power transmission line parameters, temperature and sag. In *North American Power Symposium (NAPS)*, 2011.
- [10] S.C. Müller, A. Kubis, S. Brato, C. Rehtanz, and J. Götze. New Applications for Wide-Area Monitoring, Protection and Control. In *IEEE PES Innovative Smart Grid Technologies (ISGT) Europe Conference 2012, Berlin*. 2012.
- [11] S.C. Müller, A. Kubis, S. Brato, C. Rehtanz, and J. Götze. Innovative Schutz- und Leitsysteme zur zuverlässigen und sicheren elektrischen Energieübertragung. In *VDE Kongress 2012, Stuttgart*, 2012.

## Subproject V

# Adaptive Modelling and Realtime Identification

Jürgen Götze

Uwe Ligges

Claus Weihs

# Using wide area monitoring as an approach for stability assessment in electrical transportation networks

Sebastian Brato  
Arbeitsgebiet für Datentechnik  
Technische Universität Dortmund  
sebastian.brato@tu-dortmund.de

This technical report presents new methods for detecting and indentifying stability issues in modern electrical transportation networks. For this task, an adaptive modelling and real time identification of the underlying electrical transportation system is performed. Based on this model, further algorithms estimate the stability of the system, as well as a segmentation of different network regions. Evaluation and development of modern tools for system stability analysis in conjunction with wide area monitoring is part of the research activity in DFG research unit 1511.

## 1 Introduction

New challenges in modern electrical transportation networks require the utilization of new approaches for satisfying the need of a stable network. Whilst the electrical power grid is getting more complex, the generation of power becomes more volatile. Through this combination of prevailing circumstances, new challenges arouse to keep the system in a stable equilibrium. To keep up with the new requirements, this paper presents methods which can help to get a better understanding of the dynamic evolvings within the power grid. This is done by usig data based identification techniques that will be described in

2



## 2 Understanding power system stability

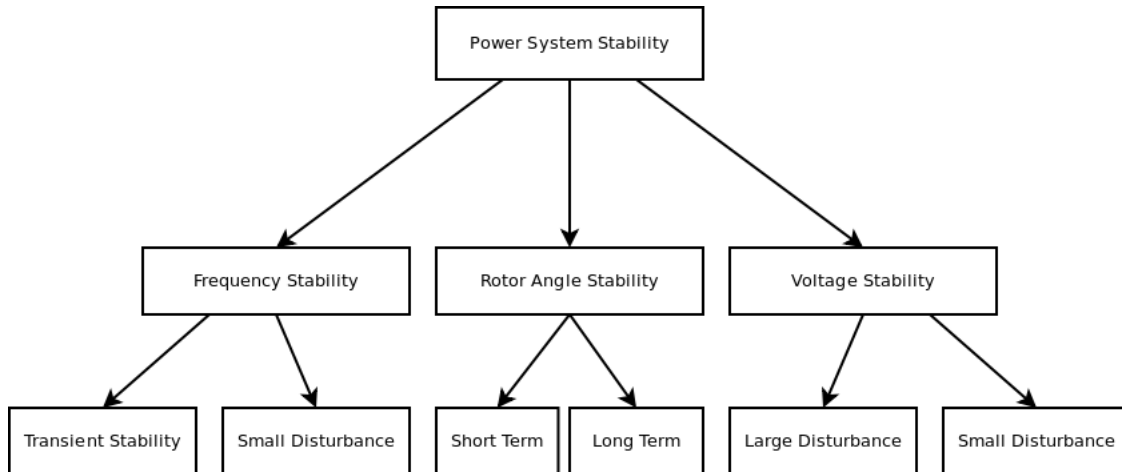

Figure 1: Classes of power system stability

Power system stability can be classified in different categories [2]. It can be divided into three main concerns as for Rotor angle, frequency and voltage stability. Within each of these categories, a more detailed classification can be done. The different stability schemes are Large or small disturbance stability and the short or long term effects that arise from a disturbance. An overview is given in figure 1.

## 3 Approaches

The chosen approach is based on data gained from the network, while keeping the network in normal operation. Traditional methods of system identification rely on the impulse or step response from a system.

As excitation the noise caused by the continuous switching of loads within the network can be used. This load caused noise represents a stochastic process, which leads to different responses from the power grid. After collecting enough data for the excitation and the network response, one is able to build a model upon this data, which then covers the main system behaviour. This model can then provide an estimation for the system stability as it can provide an estimation of the system response for arbitrary excitations. The generation of the system model is hereby only based upon data which can be measured from within the power grid with tools like Phase Measurement Units (PMU). To ensure a stable system representation, it is essential to update the model in constant time intervals. For

this task a reliable communication technology is needed, as getting up to date samples from PMUs is viable for the updating of the system model.

System identification itself can be done by various different approaches. For this paper, and Autoregressive Moving Average Model with exogenous inputs (ARMAX) as well as an Subspace based method (N4SID) has been used. The main problem is to model the nonlinearities with the power grid.

The model used for subspace based system identification complies with a standard state space system description as shown in 2

$$x_{k+1} = Ax_k + Bx_k + w_k \quad (1)$$

$$y_k = Cx_k + Du_k + v_k \quad (2)$$

whereas  $u$  describes the system input,  $y$  the system output and the vector  $x$  contains the inner system states, which are not directly observable.

The ARMAX based approach uses a time series model as described in 3.

$$A(q)y(t) = B(q)u(t - nk) + C(q) * e(t) \quad (3)$$

whereas  $A$ ,  $B$  and  $C$  denote the three system polynomials which describe the system behaviour. These polynomials are calculated based on the output data  $y(t)$ , the input data  $u(t)$  and a noise estimation  $e(t)$ .

For each model, the information of the system characteristics is enclosed within a specific system matrix or polynomial. After generating the system model and acquiring the system matrix (N4SID) or polynomial (ARMAX), it is possible to estimate the eigenvalues of the system. The eigenvalues are then used as a direct stability estimation criterion.

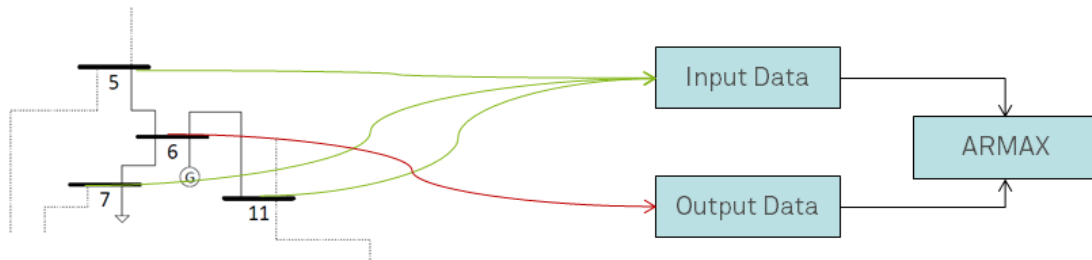

Figure 2: Generation of ARMAX Model

Based on the output of this estimated systems stability criterion, it is further possible to identify different grid parts which show a different stability behaviour. This information is useful to segment the power grid into coherent parts. As an example, a clustering for the New England Test System (NETS) is shown in 3

Clustering based on EV (Picture)

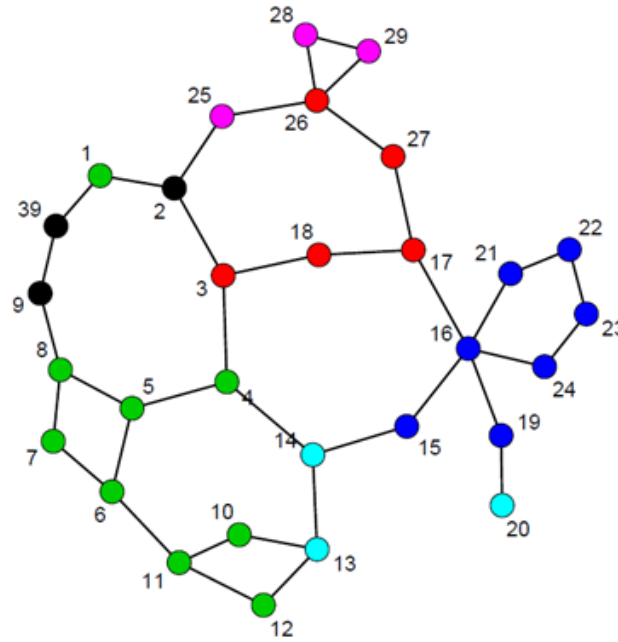

Figure 3: Network cluster

Additionally there is an energy based approach, where the excitation energy based on the load noise is monitored and the damping of that energy within the network is being observed. For a stable system the amount of energy stored at a certain frequency should decline over time if it is stable. Under this assumption, the energy measured within the power grid at a certain time step  $E(Net(t_n))$  should be smaller than the energy provided by load noise  $E(Load(t_{n-1})) + E(Net(t_{n-1}))$ .

## 4 Conclusion and outlook

A vital improvement is, to get a more realistic load model within the power grid simulation. The currently used load model is based on a standard constant power model. This model

has been extended with an random number generator to enable a certain amount of stochastic behaviour. To get a more detailed and realistic network behaviour, it is needed to extend this load model for each load within the network. The main aspect is to model each load independently, so that the loads are stochastically independent from each other. Furthermore, it should be considered to embed a load course for each load as to enable a realistic network behaviour for a whole day. This load course can deal with common events for all loads, like sunrise and sunset. With these stochastic independent (noise) and stochastic dependent (load course) events, the search space of the model to identify can be explored much deeper. This could then lead to a better system model and therefore a more sophisticated stability criterion, as with further knowledge about the system behaviour under different operating conditions the modeling tends to be more precise.

Furthermore, as this research is part of DFG FOR1151, the described algorithms will be implemented within an HLA Based Cosimulator as described in [1].

## References

- [1] Hanno Georg, Sven Christian Müller, Christian Rehtanz, and Christian Wietfeld. A HLA Based Simulator Architecture for Co-simulating ICT Based Power System Control and Protection Systems. In 3rd IEEE International Conference on Smart Grid Communications (SmartGridComm 2012), Tainan City, Taiwan, November 2012.
- [2] Prabha Kundur et al. Definition and Classification of Power System Stability. In IEEE Transactions on Power systems, Vol. 19, No. 2, May 2004.
- [3] M. Lechtenberg, J. Götze. Database assisted frequency estimation. 4th IEEE International Conference on Computer Science and Information Technology, Chengdu, China, June 2011
- [4] Sven C. Müller, Andreas Kubis, Sebastian Brato, Ulf Häger, Christian Rehtanz, and Jürgen Götze. New applications for wide-area monitoring, protection and control. In IEEE PES ISGT Europe 2012. IEEE, 2012.
- [5] S.C. Müller, A. Kubis, S. Brato, C. Rehtanz, and J. Götze. Innovative Schutz- und Leitsysteme zur zuverlässigen und sicheren elektrischen Energieübertragung. In VDE Kongress 2012, Stuttgart, 2012.

# Meta-modelling the energy simulation by Design of Experiments

Dirk Surmann, Sebastian Krey  
Fakultät Statistik  
Technische Universität Dortmund  
surmann@statistik.tu-dortmund.de

The simulation of an energy network depends on many parameters. To work out the effect of a parameter on the eigenfrequencies and their damping, this technical report shows an approach to build up a meta-model for the energy simulation. In this model all effects of the different parameters can be rated to be significant for the eigenfrequencies and their damping. Generating data in an efficient way for the model is done by design of experiments within the energy simulation. A linear regression model is fitted to the data afterwards.

## 1 Introduction

In an energy network the Low Frequency Oscillations are damped by the controllers AVR and GOV installed at the power plants. These controllers are adjusted by several parameters to damp specific frequencies. All controllers have to be adjusted globally to damp the whole spectrum of frequencies in the network. The goal of this technical report is to build up a meta-model for the energy simulation, which is able to handle the huge amount of parameters and to rate the effects to be significant.

The first part of this report describes the general approach of design of experiments and the linear regression model used as a meta-model. In the second part it is described how the proposed method has been applied to the energy simulation and the results are analysed for different orders of the model.

## 2 Meta-Model by Design of Experiments

For each controller in the energy network it is possible to adjust a large number of different parameters. Each setting needs an individual run of a corresponding simulation scenario using the energy simulation software DIgSilent, hence this is a rather time consuming task. Furthermore, the complexity of the simulation scenario makes it difficult to understand how the different controllers effect the Low Frequency Oscillation. A meta-model built on the theory of Design of Experiments [3] allows a structured examination of the behaviour of an energy network.

### 2.1 Design of Experiments

The general approach in design of experiments aims at a minimal number of experiments (number of different parameter settings) to fit a specific model, the meta-model. In the situation at hand about 2 parameters per controller and power plant are reasonable to be adjusted to influence the Low Frequency Oscillation. This results in a huge amount of possible parameter combinations (experiments), which are extremely time expensive. Running all combinations for e.g. 20 parameters on only 3 different levels for each parameter,  $3^{20}$  runs have to be performed.

Designing experiments mostly needs a model assumption that is suitable for the current situation. Typically, optimal designs arrange the experiments at the corners and on the centre of edges of the parameter space. Such a setup optimises the elected criterion and parameters of the assumed model can be estimated optimally given the number of observations. However, if it is not possible to describe the results by the assumed model, optimal designs cannot reveal the real effect of these parameters, as large regions of the parameter space are not covered with experiments. This problem can be solved by using Space Filling Designs [1]. Such a design type allows the detection of non-linear relationships by covering the whole parameter space with a desired number of experiments. This desired number is typically larger compared to the number of experiments we get from optimal designs for linear models.

### 2.2 Meta-Model

The data generated by the experiments that can be planned along the description in section 2.1 can be fitted by a linear model. A detailed analysis of the regression, especially analysis the residuals [2], shows whether the model is appropriate.

With the huge amount of parameters and the number of model terms raising exponentially for higher orders of a model, it is hardly possible to fit a linear model with a high order for our specific application.

Therefore, we assume a basic linear model only consisting of the main effects of the parameters. This so called screening model can be fitted with a minimum number of runs. If interactions or other high order effects are significantly different from zero, the model will be biased, as it does not describe these effects. However, the screening model gives a first look at the effects of the parameters and the model approach in general. For this screening model an appropriate space filling design is created. The fitted model allows a parameter reduction by removing all parameters without significant effects from the parameter space. In a physical context it can be argued, that if a main effect of a parameter is not significant, the model does not contain significant interactions or other high order terms corresponding to these effects.

With this reduced parameter space a linear model of higher order will be assumed. This step needs a new space filling design. The parameter space is reduced and the number of runs has to be appropriate for the higher order model. In the present case, the number of runs are set to  $n = 4df$ , where  $df$  is the number of degrees of freedom in the linear model. In principle, this meta-model has the capability to predict the Low Frequency Oscillation and its damping in the reduced parameter space even for parameter settings in between the design points.

### 3 Application to the energy simulation

This section shows the different steps involved in applying the theory from section 2 to the energy network.

#### 3.1 Parameter space

The first step in the regression analysis determines reasonable parameters of the controllers. Every controller in the energy simulation consists of many parameters (see [4], [5]). In table 1 reasonable controller parameters and their ranges are listed for the New England Test System (NETS) connected with the New York Power System (NYPS). In

Table 1: Parameters of the controllers

Controller	Gain	Time Constant(s)
AVR	$K_a$ (100, 500)	$T_a$ (0.01, 0.50)
GOV	$R$ (0, 0.1)	$T_c$ (0.1, 1.0)

cooperation with the Institute of Energy Systems, Energy Efficiency und Energy Economics (short ie<sup>3</sup>) at TU Dortmund University, this parameter subset and maximal stable ranges for the controller parameters were defined.

Each power plant has its own controllers, hence the parameters can differ as well. With 16 power plants in the NETS-NYPS energy network there are  $16 \cdot 4 = 64$  parameters that can be changed. However, looking for Low Frequency Oscillations means looking for an inter-area oscillation. In the energy system at hand the power plants are already arranged in five areas by  $ie^3$ . Non-uniform parameter changes for the controllers of the power plants within one area can cancel out their effect on the inter-area oscillation. Eliminating this type of changes results in a parameter space with 20 parameters.

## 3.2 Response Variables

To describe the impact of different parameter settings, all eigenfrequencies and their damping are calculated by the energy simulation for each parameter setting. Here, the software DlgSilent is used, which combines the eigenfrequency and the damping in a complex number and calls it eigenvalue. Its imaginary part divided by  $2\pi$  describes the eigenfrequency in Hz, whereas the real part describes the damping of the eigenfrequency in  $\frac{1}{s}$ . Note that DlgSilent returns the eigenvalues and the conjugate complex version of the eigenvalue, hence we have to remove one of these two redundant versions.

## 3.3 Data Preparation

The results of a design of experiment with 80 runs to fit a linear model with main effects shows the need for different steps of data preparation. In the first step all eigenvalues with a frequency less than 0.1 Hz will be removed, as the frequency of the inter-area oscillation in the NETS-NYPS system is known to be higher. This purges all conjugate-complex eigenvalues and all eigenvalues with a very low frequency. DlgSilent orders the eigenvalues on its own, which makes it almost impossible to identify the eigenvalue that correspond to each other in different the runs. Unfortunately, such an identification is important for analysing the 80 runs in a regression model. A good guess can be made by matching the eigenvalues by their frequencies. The following figure shows the sorted remaining eigenvalues exemplary for runs 1 and 9. The red dots describe the frequency of an eigenvalue with annotation on the left axis. On the right axis the damping is plotted in blue. Obviously, the different settings between run 1 and run 9 have an effect on the frequency and the damping of each eigenvalue. In figure 2, the frequency of the sixth eigenvalue is plotted exemplary over the 80 runs. The frequency changes between the different runs, but the figure shows a normal range of variation around the mean at  $\sim 0.17$  Hz of the sixth eigenvalue.



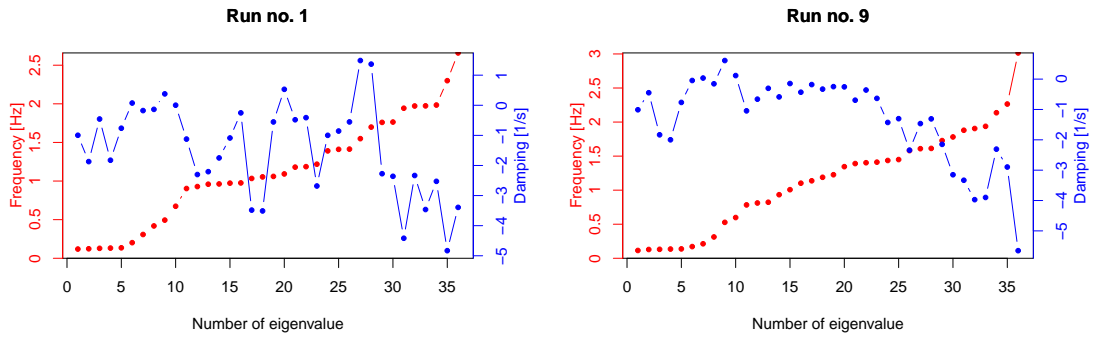

Figure 1: Frequency and Damping for the sorted eigenvalues

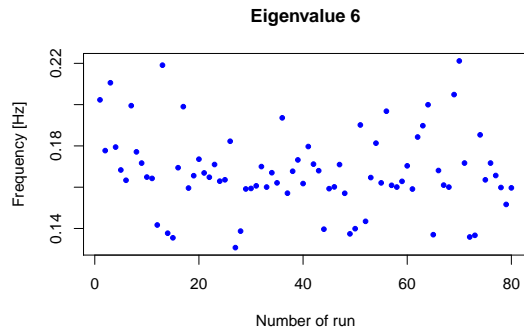

Figure 2: Frequencies of the sixth eigenvalue over the number of runs

### 3.4 Regression Analysis

The regression analysis fits the assumed linear model to the data generated in the energy simulation. In the first step, a model containing only the main effects of the parameters is assumed. The model with its 21 parameters is shown in equation 1.

$$EF_i = \beta_0 + \sum_{k \in P} \sum_{j=1}^5 \beta_j^k \cdot k + \varepsilon_i \quad \text{with} \quad P = \{K_a, T_a, R, T_c\} \quad \text{and} \quad \varepsilon_i \stackrel{iid}{\sim} \mathcal{N}(0, \sigma_\varepsilon^2) \quad (1)$$

A space filling design with 80 runs is performed in the energy simulation to generate the data. The response  $EF_i$  in this regression model is exemplary for the frequency of the sixth eigenvalue. A residual analysis verifies the model assumption of normally distributed residuals. The model with all main effects has an adjusted coefficient of determination of  $R_{adj}^2 = 0.198$ , which shows a rather bad explanatory power. The estimated effects  $\beta_0$  and  $\beta_j^k$ , for the frequency of the sixth eigenvalue, and their corresponding confidence intervals to a significance level of 5% are listed in table 2. After performing a forward-backward selection only the main effect of the Gain ( $R$ ) for the GOV controller in the second area is significant. The  $R_{adj}^2$  raises to 0.214, hence 80% of the variance cannot be explained by the screening model. The second area, with the significant GOV Gain, connects the NETS with the NYPS and includes the biggest generator of both networks. All other controllers are not able to influence the sixth eigenvalue in a significant way.

Having in mind to perform the second stage with a model of higher order and a reduced number of parameters, this model would contain only one parameter, which is not reasonable. With a coefficient of determination of 0.2 in the screening stage, the model approach seems to be wrong given that available data, or some higher order effects influence the model rather strongly. Getting an idea which of these two problems is the reason of small  $R_{adj}^2$ , the number of parameters in the second stage is not reduced. Because the data is generated in a computer simulation, this is worth the effort.

A full linear model of second order contains all main effects, second order interactions and quadratic effects. With 20 parameters, 230 effects plus the constant have to be estimated. The space filling design for this model consist of 920 runs. After the same data preparation as for the screening model, some equivalent plots to those in figure 1 show the same behaviour. Though the plot of the frequency of one eigenvalue over the number of runs shows a slightly different behaviour as shown in figure 3. Most frequencies are around or above 0.16 Hz. Some are around 0.14 Hz, almost with a gap between these two frequencies. Obviously, sorting the eigenvalues by their frequencies does not solve the ordering problem in DlgSilent from run to run. The frequencies around 0.14 Hz belong to the eigenvalue number five with mean frequency of about 0.14 Hz. In the regression analysis these values are ignored because a sufficient number of degrees of freedom are left.

Table 2: Coefficients and confidence intervals ( $CI$ ) of the effects for the frequency of the sixth eigenvalue to a significance level of 5 %

Area	Term	Coefficient	$CI_u$	$CI_o$
—	$\beta_0$	0.193	0.153	0.233
1	$AVR_{Ka}$	$-3.300 \times 10^{-5}$	$-6.970 \times 10^{-5}$	$3.760 \times 10^{-6}$
1	$AVR_{Ta}$	0.000	-0.032	0.032
1	$GOV_R$	-0.118	-0.275	0.038
1	$GOV_{Tc}$	-0.007	-0.024	0.010
2	$AVR_{Ka}$	$2.240 \times 10^{-5}$	$-1.540 \times 10^{-5}$	$6.030 \times 10^{-5}$
2	$AVR_{Ta}$	0.001	-0.031	0.032
2	$GOV_R$	-0.340	-0.507	-0.173
2	$GOV_{Tc}$	0.002	-0.014	0.019
3	$AVR_{Ka}$	$8.160 \times 10^{-6}$	$-3.410 \times 10^{-5}$	$5.040 \times 10^{-5}$
3	$AVR_{Ta}$	-0.016	-0.048	0.016
3	$GOV_R$	-0.103	-0.252	0.045
3	$GOV_{Tc}$	-0.010	-0.029	0.010
4	$AVR_{Ka}$	$8.420 \times 10^{-7}$	$-4.290 \times 10^{-5}$	$4.460 \times 10^{-5}$
4	$AVR_{Ta}$	0.003	-0.026	0.032
4	$GOV_R$	0.106	-0.077	0.288
4	$GOV_{Tc}$	0.000	-0.016	0.016
5	$AVR_{Ka}$	$-1.080 \times 10^{-5}$	$-5.050 \times 10^{-5}$	$2.890 \times 10^{-5}$
5	$AVR_{Ta}$	0.025	-0.007	0.057
5	$GOV_R$	0.088	-0.066	0.241
5	$GOV_{Tc}$	-0.003	-0.020	0.014

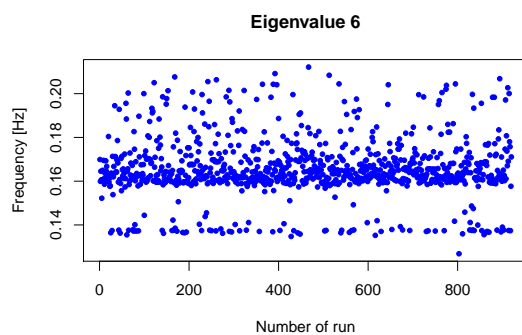

Figure 3: Frequencies of the sixth eigenvalue over the number of runs

The regression analysis of the second order linear model shows a better coefficient of determination of 0.655. A forward-backward selection to a significance level of 5 % reduces the model from 231 to 40 effects with a  $R_{adj}^2 = 0.672$ . As the significance level of 5 % implies, every 20th effect of the starting model will be significant just by chance. Hence about 12 of the significant 40 effects could be significant by chance only, hence it is hardly possible to give a reasonable interpretation of the model. In addition, with the prior argumentation of having only higher order effects to be significant in a physical environment when the main effects are significant in a screening model, the reduced second order model is not reliable to predict the frequency of Low Frequency Oscillations.

## 4 Summary

This technical report describes an approach to build up a meta-model for the frequencies of the eigenvalues by design of experiments. After constructing a space filling design for a linear model, the eigenvalues are calculated in the energy simulation software for the different parameter settings in the design space. After identification of the eigenvalues between different runs, a regression model is fitted to the eigenvalues. The regression analysis of the linear model shows a bad explanatory power of the first order model. A parameter reduction based on this model is not reasonable because only one parameter stays in the model. The second order linear model contains 40 significant effects, of which about 12 could be significant by just chance.

The goal to build a linear meta-model using design of experiments shows a deficiency in modelling the data. Hence it is not possible to create a simple model to describe the effects of the different analysed controller parameters on the Low Frequency Oscillations.

Using another subset of controller parameters or non-linear models can improve the quality of the regression model.

## 5 Acknowledgement

This work has been supported by the Deutsche Forschungsgemeinschaft, Forschergruppe 1511.

## References

- [1] David R. Cox and Nancy Reid. *The Theory of the Design of Experiments*. Number 86 in Monographs on statistics and applied probability. Chapman & Hall, July 2000.
- [2] Jürgen Gross. *Linear Regression*. Number 175 in Lecture Notes in Statistics. Springer, Berlin, 2003.
- [3] Douglas C. Montgomery. *Design and Analysis of Experiments*. John Wiley & Sons, Hoboken, 8 edition, June 2012.
- [4] Bikash Pal and Balarko Chaudhuri. *Robust Control in Power Systems*. Springer, New York [u.a.], 2005.
- [5] Graham Rogers. *Power System Oscillations*. Kluwer Academic, Boston [u.a.], 2000.

## Subproject VI

# Real-Time Capable and Fault-Tolerant Execution Platform and Communication Networks

Peter Marwedel

Olaf Spinczyk

Christian Wietfeld

# Performance Evaluation of Communication Networks for Cyber Physical Energy Systems

Nils Dorsch

Lehrstuhl für Kommunikationsnetze

Technische Universität Dortmund

nils.dorsch@tu-dortmund.de

Caused by ongoing developments in the energy sector, i.e. connection of renewable energy sources and emerging energy trade, power grids are about to undergo fundamental changes. Real-time monitoring and control are becoming an inevitable factor in order to maintain grid stability. However, this can only be achieved with the help of a reliable, high data rate communication infrastructure for transmitting time-critical status data and control commands. A well-accepted framework for Smart Grid communication has been proposed by the standard IEC 61850. We pursue to model and evaluate Smart Grid communication according to IEC 61850 with the help of the analytical technique of Network Calculus and simulations. A bottom-up approach has been chosen for analysis, starting from small scenarios covering bay level communication up to wide area communication based on the IEEE 39-bus New England Test System (NETS).

## 1 Introduction

With the deregulation and liberalization of the European energy market energy trade became increasingly attractive. At the same time, energy generation experiences decisive changes, turning away from fossil towards renewable energy sources, such as solar or wind power. However, renewable energy sources are not available at all times and thus cause fluctuating feed-in. In combination with emerging energy trade this leads in turn

to varying, less predictable power flows, which will put pressure on the power grid and even endanger its stability. To keep up with this development, real-time monitoring and control is required for the future power grid. However, to enable the transmission of messages carrying e.g. measurement values, status information or switching commands, it is necessary to provide an appropriate communication infrastructure for power grids. In order to identify and react quickly to failures within the power grid, the communication network needs to reflect the time-criticality of the application, ensuring that the packet delay does not exceed certain boundaries, required by the standard IEC 61850. This work presents two approaches - the Network Calculus and simulations - for evaluating the real-time capability of IEC 61850 communication services on different levels of the communication network. In the following, section 2 provides a short overview of the standard IEC 61850 along with a topology description of the communication network. Afterwards, the two modelling approaches for analysing the communication infrastructure of power grids are introduced in section 3. Section 4 concludes and gives an outlook on future work.

## 2 Communication in Power Grids

First, this section highlights the most important aspects of the standard IEC 61850 and afterwards provides a brief overview of the topologies, which have been considered for evaluating the performance of Smart Grid communication.

### 2.1 Standard IEC 61850

The standard IEC 61850 [8] has been initially proposed by the *International Electrical Commission* (IEC) *Technical Committee* (TC) 57 as a comprehensive standard for substation automation, covering communication services and topologies as well as a common data model and time requirements. Recently, IEC 61850 is being advanced for the use in inter-substation communication and for the data transmission regarding the connection of renewable energy sources. Thus the standard develops towards an overall framework for communication within power grids. IEC 61850 comprises three major communication services. Sampled Value (SV) messages are used for monitoring purposes on the bay level of substations, which is the lowest level of the power grid. These messages are initiated by merging units (MU), which collect measurement values from measurement transformers, and sent periodically to the bay controller and protection devices. Generic Object Oriented Substation Event (GOOSE) packets serve for providing updates on the status of devices such as circuit breakers and protection devices as well as for the transmission of switching commands. Due to both message types being extremely time-critical, they are encapsulated directly on MAC-layer and employ prioritisation according



to IEEE 802.1Q. In contrast, the Manufacturing Message Specification (MMS) applies client-server-communication, using the complete TCP/IP protocol stack.

## 2.2 Topologies

Communication within power grids is organised hierarchically, ranging from the local transmission of measurement data to wide area communication of switching commands, as depicted in figure 1.

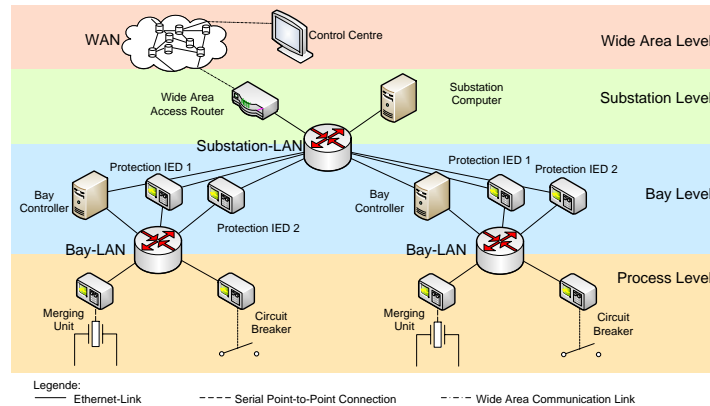

Figure 1: Hierarchy of Power Grid Communication

Starting at the bottom level, a typical substation bay consists of MU, collecting measurement values, a bay controller (BC), aggregating bay data and providing local access, a circuit breaker (CB) and a number of protection devices. These devices might either be connected with the help of serial links or by a bay local area network (LAN). On substation level, bay controllers and protection devices from different bays exchange information with a central substation controller (SPC) via the substation LAN. In this work on both substation and bay level star shaped topologies are assumed for the respective LAN. Regarding wide area communication the New England Test System (NETS) is used as a reference network. A wide area access router, which is attached to the substation LAN as well, enables data exchange with other substations and the control center.

## 3 Modelling Approach

The performance of the communication infrastructure within power grids has been studied, focussing in particular on the maximum delay of messages in order to evaluate the system's real-time capability. Various scenarios were set up, mapping communication on different levels of the power grid. Communication according to the standard IEC 61850

has been modelled using the analytical approach of Network Calculus on the one hand and simulations on the other hand.

To demonstrate our approach, we provide results for a small substation scenario, consisting of substation level devices as well as one bay, which can be derived from the general architecture in figure 1. With regard to traffic flows, we assume the SPC to randomly inquire status values from the protection IED by means of MMS Read Requests with an inter arrival time of 1 ms. In turn, the protection IED sends MMS Read Responses to the SPC. At the same time, the BC publishes MMS Reports via the substation LAN, to which the SPC is subscribed. In addition, GOOSE message serve for providing time-critical status updates from the bay level devices to the SPC.

### 3.1 Network Calculus

Network Calculus is an analytical modelling technique for determining worst-case boundaries on the performance of communication networks, which has been introduced by Cruz [2] in 1991. In recent years it has been developed to a complete analytical framework employing a special algebra, the so-called Min-Plus algebra, and was further advanced to a stochastic version [4] in order to exploit multiplexing gains.

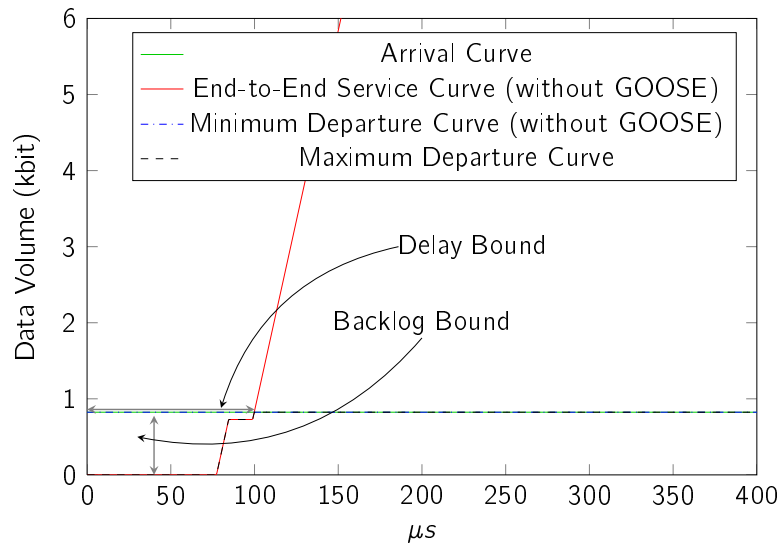

Figure 2: NC results - MMS Read Response data volume on substation level

Complying with the concept of Deterministic Network Calculus, arrival curves for SV, GOOSE and different types of MMS messages have been generated, mapping the characteristics of the arriving traffic such as packet size and inter arrival times. On the other hand, service curves describe the transmission of packets via communication links and the processing of packets at switches or routers, incorporating parameters like processing

rates, data rates or propagation delays. In order to obtain direct end-to-end performance bounds, Network Calculus enables the computation of an end-to-end service curve by concatenating the service curves of subsequent nodes using the Min-Plus convolution. As a result, upper bounds on the delay and backlog of traffic flows can be determined, which can be graphically interpreted as the maximum horizontal respectively vertical distance between arrival and service curve. Moreover, it is possible to gain information on the outgoing traffic at a node by calculating minimum and maximum departure curve. For calculation and graphical visualisation a JAVA toolbox has been developed, using Network Calculus computation algorithms presented in [7] and [1]. Figure 2 shows analytical results for MMS Read Responses, considering the scenario described above. In this case, an upper delay bound of  $99.84 \mu s$  and an upper backlog bound of  $824 \text{ Bit}$ , which is equivalent to one packet, can be determined.

### 3.2 Simulation

For validation of the analytical results, simulations have been designed using OPNET Modeler [10], enabling detailed modelling of the communication according to IEC 61850. However, simulations are not actually capable of delivering worst-case boundaries in case of random traffic, but rather provide average values along with precise insight into communication processes. In order to gain the maximum delay of messages, several simulation runs with varying seeds of the random number generator (RNG) have been executed over a relatively long period. On principle, a generic node model from the OPNET Modeler has been extended to serve as a common node model for IEC 61850 communication services.

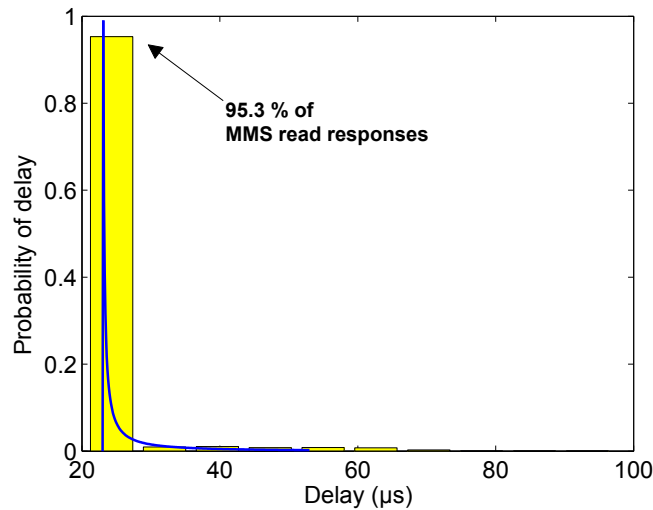

Figure 3: Simulation results - MMS Read Response data volume on substation level

Therefore additional layers for traffic generation of SV and GOOSE messages have been introduced. In order to integrate these layers into the node model, a specific adaption module has been added, which interconnects them to the MAC layer. Moreover the MAC layer had to be modified to support and identify SV and GOOSE messages. The MMS service has been modelled in terms of new process models on the application layer of the TCP/IP protocol stack. In the following, we provide results for MMS Read Responses, gained by simulation, in compliance with the analytical performance evaluation. Yet, since both the MMS and GOOSE service involve random packet arrivals, 100 simulation runs have been carried out over a simulation period of five minutes, eventually delivering a maximum delay of  $97.12 \mu s$ . Compared to Network Calculus' upper delay bound of  $99.84 \mu s$ , this turns out to be a quite close match. Figure 3 presents the probability of occurrence for different delays, highlighting that the maximum delay might only be observed in very few cases.

## 4 Conclusion

Communication on different levels of the power grid has been evaluated regarding its real-time capability in terms of delay using the analytical modelling approach of Network Calculus along with simulations. We provided exemplary results for the MMS communication service in a small substation scenario, demonstrating the good match of Network Calculus results and simulation results for this case. Following the same approach, [5] provides detailed results for IEC 61850 based bay level communication, while a comprehensive performance analysis, covering bay, substation and inter-substation communication can be found in [3]. Enhanced results on substation and wide area communication will be published subsequently.

	<b>Network Calculus</b>	<b>Simulation</b>
<b>Results</b>	good match	
<b>Execution time</b>	seconds	hours
<b>Modelling effort</b>	low	high
<b>Tool support</b>	poor	various tools available
<b>Worst-case boundaries</b>	yes	(yes)

Table 1: Comparison NC - Simulation

With regard to our approaches for performance evaluation, it has to be highlighted, that simulations provide detailed models of IEC 61850 based communication, while the Network Calculus enables direct calculation of worst-case boundaries on the delay within short execution times. Table 1 presents a concluding comparison of two approaches. In future work, the simulation models for IEC 61850 based communication will be integrated into the INSPIRE hybrid simulator, which has been introduced in [6], [9] and which enables

the co-simulation of energy and communication networks. Moreover, additional scenarios will be analysed, e.g. studying the impact of connecting large numbers of renewable energy sources or the performance in case of failures in the communication network or power grid.

## References

- [1] Anne Bouillard and Éric Thierry. An algorithmic toolbox for network calculus. *Discrete Event Dynamic Systems*, 18(1):3–49, March 2008.
- [2] R. L Cruz. A calculus for network delay. i. network elements in isolation. *IEEE Transactions on Information Theory*, 37(1):114–131, January 1991.
- [3] Nils Dorsch. Analytical modelling and validation of real-time communication in smart grids. Master's thesis, TU Dortmund University, Communication Networks Institute, 2012.
- [4] M. Fidler. Survey of deterministic and stochastic service curve models in the network calculus. *Communications Surveys Tutorials, IEEE*, 12(1):59–86, 2010.
- [5] Hanno Georg, Nils Dorsch, Markus Putzke, and Christian Wietfeld. Performance Evaluation of Time-critical Communication Networks for Smart Grids based on IEC 61850. In *2013 IEEE INFOCOM Workshop on Communications and Control for Smart Energy Systems (INFOCOM'2013 CCSES)*, Turin, Italy, April 2013.
- [6] Hanno Georg, Sven Christian Müller, Christian Rehtanz, and Christian Wietfeld. A HLA Based Simulator Architecture for Co-simulating ICT Based Power System Control and Protection Systems. In *3rd IEEE International Conference on Smart Grid Communications (SmartGridComm 2012)*, Tainan City, Taiwan, November 2012.
- [7] Nicos Gollan, Frank A. Zdarsky, Ivan Martinovic, and Jens B. Schmitt. The DISCO network calculator. *Measuring, Modelling and Evaluation of Computer and Communication Systems (MMB), 2008 14th GI/ITG Conference -*, pages 1–3, April 2008.
- [8] IEC TC57. IEC 61850: Communication networks and systems in substations .
- [9] Sven C. Müller, Hanno Georg, Christian Rehtanz, and Christian Wietfeld. Hybrid simulation of power systems and ICT for real-time applications. In *3rd IEEE PES Innovative Smart Grid Technologies (ISGT) Europe Conference*, Berlin, Germany, October 2012.
- [10] OPNET Technologies Inc. OPNET Modeler. 17.1.A PL2.

# Evaluation of the Virtualized Execution Platform

Boguslaw Jablkowski  
Lehrstuhl für Informatik 12  
Technische Universität Dortmund  
boguslaw.jablkowski@tu-dortmund.de

This technical report presents first evaluation results of the virtualized execution platform for the power systems monitoring, control and protection software. First, the technique of live-migration is being analyzed. Next, we investigate a high availability approach for fault-tolerance. Finally, the scheduling properties of our virtualization solution are being inspected. This article concludes with an outlook on future work. The presented work is part of the research activity in DFG research unit 1511.

## 1 Introduction

There are two main challenges to the domain of *Cyber-Physical Systems* (CPS) - to guarantee fault-tolerance and the fulfilment of real-time constraints. Due to the good fault-tolerance properties of the virtualization technique, we have chosen it for the implementation of the execution platform for the monitoring, protection and control software. Virtualization offers strong isolation - both in space and time dimension - of *Virtual Machines* (VM) and the applications running within. It also facilitates system administration and through workload- and hardware consolidation it enables savings in procurement- and maintenance costs. However, in the domain of power systems satisfying these concern is not enough. The protection and control applications are embedded in real-time activities. Therefore, to avoid damage domain specific real-time constraints have to be strictly fulfilled. In the following section we will present our architecture and analyze its timing properties in respect to some of its core features. This article closes with the description of future work.

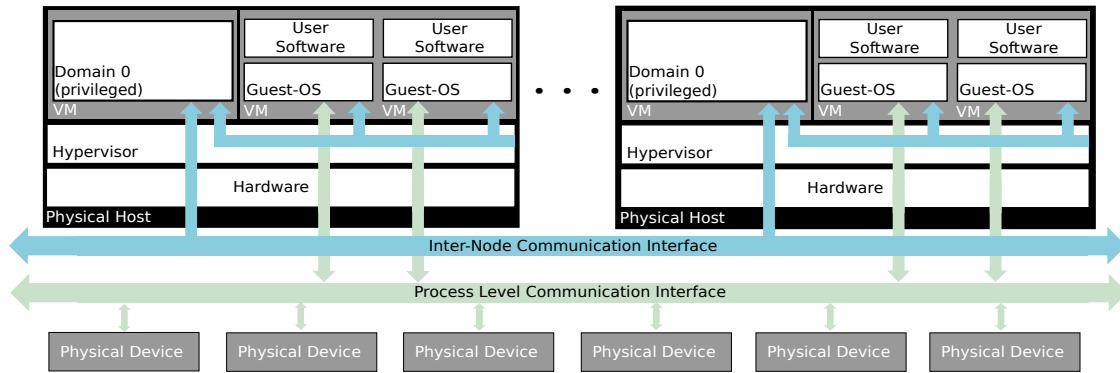

Figure 1: Architecture of the execution platform

## 2 Execution Platform

The concept of our virtualized architecture for the monitoring, protection and control software was first presented in [5]. We have implemented the prototype of our execution platform using Xen [2] version 4.1.2. Xen is an established open-source solution for platform virtualization with interesting fault-tolerance and management techniques. The architecture of the execution platform is depicted in Figure 1. Every physical node represents a server hosting a specific number of virtual machines which are composed of an application and a tailored operating system. All nodes have an unique VM, called *Domain0* (Dom0), which starts at boot time and handles the interaction between the other VMs and the physical I/O resources. Both the Dom0 and the guest VMs (DomUs) are being managed by the hypervisor. Our execution platform assumes three communication interfaces. One is virtual and is only being used inside a computational node for the communication between Dom0 and other DomUs. The inter-node interface creates the communication infrastructure for the information exchange between the different nodes of the execution platform. It handles the data transfer for the management and fault-tolerance solutions. Finally, the process level interface enables communication of the bay level with the execution platform. It facilitates the data exchange between physical devices and bay controllers or protection units. In our approach these are implemented in the applications running inside the virtual machines.

### 2.1 Test Bed

In our experiments, we used to following infrastructure. The Xen 4.1.2 hypervisor was installed on two servers, consisting each of an Intel Core 2 Quad 2,83 GHz processor with hyperthreading disabled, 4 GB of RAM and an integrated Intel 82566DM-2 Gigabit Ethernet. The operating system for both servers was Debian Linux 2.6.32.40. The host were connected by a 1 Gbps switch.

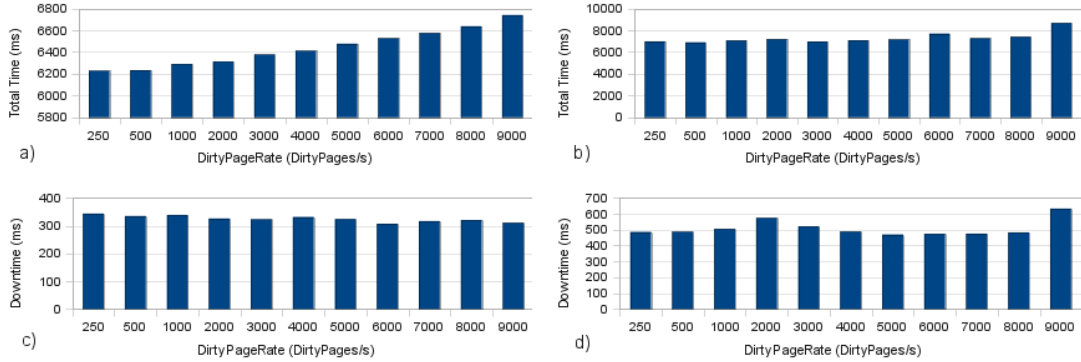

Figure 2: Effect of Dirty Page Rate on Total Migration Time and Downtime. a) Mean values for Total Migration Time. b) Worst-Case values for Total Migration Time. c) Mean values for Downtime. d) Worst-Case values for Downtime

## 2.2 Live-Migration

Live migration is a core feature of virtualization which enables dynamic reconfiguration of complex systems at runtime. It allows to move a running VM between different physical hosts, preserving at the same time its state, memory, storage and network connections. It creates an illusion of service continuity despite the migration of this service from one physical location to another. Unfortunately, its only an illusion. In order to finish a migration process every moved VM - and therefore the service running within - have to be interrupted for a short period of time. There are two important parameters while analyzing live migration. One is the *total migration time* - the time needed to move the entire VM from one physical location to another - and the mentioned *downtime* - a period of time in which the service is not responsive. Every implementation of live migration involves a tradeoff between these two parameters. As for us, the latter is critical, as our platform is to host services with real-time constraints. The theoretical upper and lower bounds for downtime and total migration time are given in [1].

There are three main factors that influence the migration process. The *VM memory size* - which is the amount of RAM that has been allocated for a given VM, the *page dirty rate* - determining at which rate an application is modifying the memory, and the *link bandwidth* of the communication interface. The link capacity is constant in all our experiments and was 1 Gbps. In order to model the different VMs behaviour regarding memory usage, we developed a simple userspace application which writes memory pages at definable rates. For the evaluation process we used a Core Linux guest VM with 64MB-RAM and conducted 400 live migrations per each dirty page rate. Figure 2 depicts the results of our live migration evaluation.



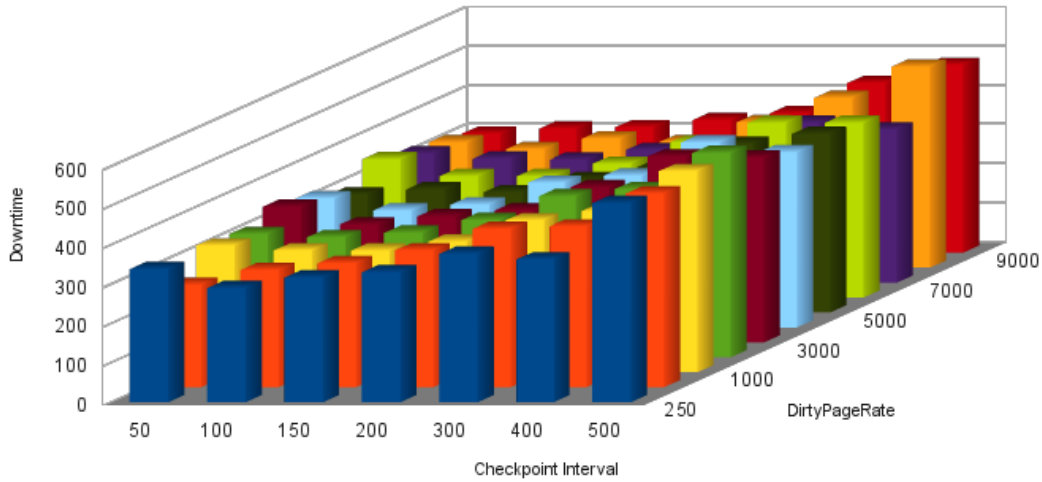

Figure 3: Effect of checkpoint intervals on service downtime in (ms)

## 2.3 Remus

Remus [3] is a high-availability solution for fault-tolerance. It allows applications to survive hardware failures, including the failure of an entire physical host. Remus is based upon the concept of asynchronous VM replication and the technique of live migration. Since Xen 4, Remus is part of the Xen distribution and is integrated in the xen-toolstack. In order to protect a VM from a fail-stop failure Remus instantiates its replica on a different physical host and asynchronously propagates state changes of the primary VM to the backup host. In case the primary host fails, the backup host automatically takes over. Still, for a short period of time the service is not responsive. As in the case of live migration, the duration of this service downtime is crucial to our platform. To minimize downtime the user can choose the frequency of the checkpointing interval. The shorter the interval, the better the downtime values. However, at the same time the overhead for pausing and checkpointing of the VM is increasing. In order to evaluate Remus we have implemented a benchmark-suite which allows both the analysis of the service downtime as well as the network traffic. The tradeoff between checkpoint intervals and service downtime is illustrated in Figure 3. For every checkpoint interval and dirty page rate the VM was crashed and restored 140 times. The results are average values. As one can see the downtime is mainly constrained by the checkpoint interval and not the dirty page rate. The network traffic generated by Remus for an idle VM is represented in Figure 4. The first peak represents the data for the complete transfer of the primary VM to the backup host. The second part of the diagram shows the data amount for the checkpointing of operating system activities, as in this case there is no user software running in the VM.

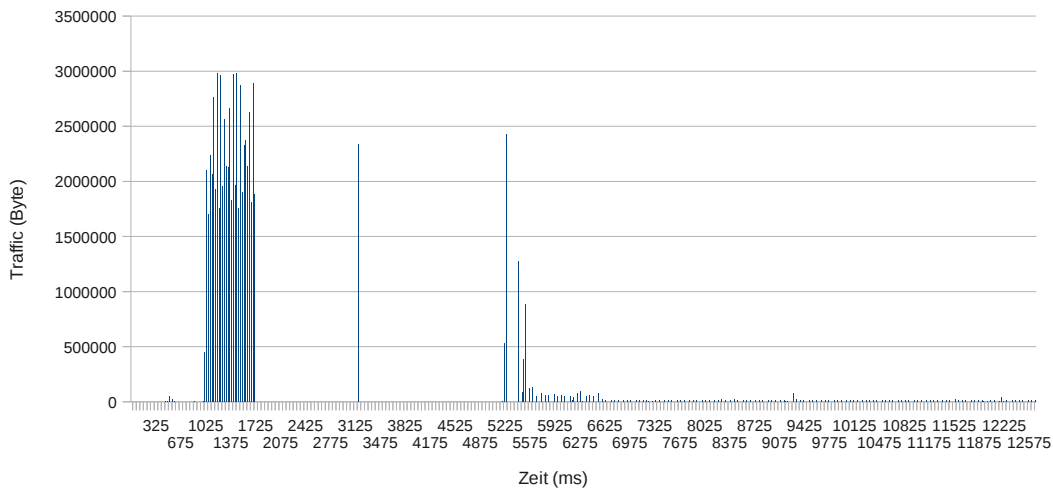

Figure 4: Network traffic generated by Remus

## 2.4 Scheduling

Xen supports two default scheduling algorithms for the distribution of resources to VMs: the *Credit*- and the *Simple Earliest Deadline First* (SEDF)-scheduler. The Credit-scheduler is a best effort scheduler, focusing on the resource utilization level and therefore not suited for scheduling real-time systems. In our experiments we used the SEDF-scheduler. The initial question to answer was: does the Xen SEDF-scheduler correctly distributes the CPU-resources to VMs? At an abstract level scheduling in Xen is done by switching among *virtual CPUs* (VCPU), which had previously been assigned to physical cores. Every VM has to be mapped to at least one VCPU and at most to the number of available physical CPUs. In case of the SEDF-scheduler three additional parameters have to be defined: a *slice* - a budget that is being consumed by a running VCPU, a *period* - a period of time after the slice is to be refreshed, and *extratime* - a flag to decide if the VCPU is to get extra time even if it has ran out of slice. In order to evaluate a basic scheduling scenario we instantiated three paravirtualized NetBSD guest VMs with different SEDF-scheduler values on one physical core with only one VCPU per VM. The extratime flag was set to 0 for all VMs. Further, we implemented a simple user space application to introduce maximal CPU-workload to the given three VMs. These values and the evaluation results for distribution of CPU-resources by the SEDF-scheduler are shown in Table 1. The CPU-time represents the average time a physical core was assigned to the given VM (VCPU). This mean value was calculated from 100 period iterations. The CPU utilization for this scenario was 96,66%. The difference between the defined slice and the CPU-time - about  $50\mu\text{s}$  for all three VMs - is related to the context switch overhead. None of the CPU-time values fell below the slice threshold.

VM	Period	Slice	CPU-Time
1	30000000	14000000	14050935
2	30000000	5000000	5050659
3	30000000	10000000	10050495

Table 1: Average CPU-Time for a given VM. Values in nanoseconds (ns).

### 3 Conclusion and Outlook

The evaluation of our execution platform is in an early phase, the scope has to be expanded and the results have to be further analyzed. There is still too much noise in the collected data, both for live migration as well as for Remus. The sources of these uncertainties have to be identified. These are to be the next steps. Further, we already started to evaluate scenarios involving distributed applications and therefore communication. In addition, we are modelling these scenarios with analytical techniques (MPA-RTC [6], MAST [4]), in order to estimate - at an abstract system level - the performance bounds for our execution platform. Due to the formal nature of these techniques, these performance bounds can be mathematically proven correct, which is crucial to guarantee the safety execution of critical real-time applications. Therefore, further evaluation of the execution platform and investigation regarding the modelling properties of the analytical approaches and the quality of the computed performance bounds is worthwhile and needed.

### References

- [1] S. Akoush, R. Sohan, A. Rice, A.W. Moore, and A. Hopper. Predicting the performance of virtual machine migration. In *Modeling, Analysis Simulation of Computer and Telecommunication Systems (MASCOTS), 2010 IEEE International Symposium on*, pages 37–46, 2010.
- [2] Paul Barham, Boris Dragovic, Keir Fraser, Steven Hand, Tim Harris, Alex Ho, Rolf Neugebauer, Ian Pratt, and Andrew Warfield. Xen and the art of virtualization. *SIGOPS Oper. Syst. Rev.*, 37(5):164–177, October 2003.
- [3] Brendan Cully, Geoffrey Lefebvre, Dutch Meyer, Mike Feeley, Norm Hutchinson, and Andrew Warfield. Remus: High availability via asynchronous virtual machine replication. In *In Proc. NSDI*, 2008.
- [4] M. Gonzalez Harbour, J.J. Gutierrez Garcia, J.C. Palencia Gutierrez, and J.M. Drake Moyano. Mast: Modeling and analysis suite for real time applications. In *Real-Time Systems, 13th Euromicro Conference on, 2001.*, pages 125–134, 2001.

- [5] Boguslaw Jablkowski and Olaf Spinczyk. Continuous performance analysis of fault-tolerant virtual machines. In *Proceedings of the 1st GI Workshop on Software-Based Methods for Robust Embedded Systems (SOBRES '12)*, Lecture Notes in Informatics, pages 494–505. German Society of Informatics, September 2012.
- [6] Lothar Thiele, Samarjit Chakraborty, and Martin Naedele. Real-time calculus for scheduling hard real-time systems. In *in ISCAS*, pages 101–104, 2000.