

Energy-Efficient Design of Optical Transport Networks

Eingereichte Dissertation zur Erlangung des akademischen Grades
Doktor der Ingenieurwissenschaften (Dr.-Ing.)
der Fakultät für Elektrotechnik und Informationstechnik
der Technischen Universität Dortmund

vorgelegt von

Jorge López Vizcaíno

München, den 01 Dezember 2016

Hauptreferent: Prof. Dr.-Ing. Peter Krummrich

Korreferent: Prof. Dr.-Ing. Andreas Kirstädter

Energy-Efficient Design of Optical Transport Networks

Eingereichte Dissertation zur Erlangung des akademischen Grades
Doktor der Ingenieurwissenschaften (Dr.-Ing.)
der Fakultät für Elektrotechnik und Informationstechnik
der Technischen Universität Dortmund

vorgelegt von

Jorge López Vizcaíno

München, den 01 Dezember 2016

Hauptreferent: Prof. Dr.-Ing. Peter Krummrich

Korreferent: Prof. Dr.-Ing. Andreas Kirstädter

ACKNOWLEDGEMENT

Firstly, I would like to acknowledge the guidance and valuable contributions into this thesis of Prof. Peter M. Krummrich. From the beginning, through fruitful discussions, he provided me with wise inputs which guided me along all this way to get my PhD thesis. Without his experienced knowledge, elaborating this thesis would have not been possible. Special thanks to Prof. Kirstädter and the Doctoral Committee of the Technical University of Dortmund for reviewing my thesis and providing valuable feedback to my research work.

Dr. Yabin Ye also deserves a special mention for the close supervision of my work at the European Research Center of Huawei Technologies in Munich. During these last years, he has always been willing to discuss any problem or idea with me and to give me valuable feedback and suggestions. I would like to thank him for all his help. I would also like to express my gratitude to the managers of the Optical Technology department at the European Research Center of Huawei Technologies, Yang Ning and Sun Chun, who gave me the opportunity to carry out my PhD studies in this institution after finishing my MSc thesis. Moreover, I would like to thank the colleagues I shared the office with during the last years (Fabio, Fabian, Changsong, Nebojsa, Le Binh, Mao, Zhao Yu, Qi Juan, Neil, Gernot, Florian, Fotini, Javier, Paola, Cristian, Thomas and Mike). My work would certainly have not been the same without them.

During the time I worked towards my doctoral degree, I also had the opportunity to meet and discuss with many experts on the field outside my institutions, especially through my involvement in the EU FP7 TREND project. I would like to thank the TREND participants with whom I had an opportunity to collaborate and fruitfully discuss my ideas (Filip, Francesco, Luca, Edoardo, Ward, etc.), and especially to Felipe Jiménez and Víctor López who invited me to closely work with them at Telefónica in Madrid and enriched my publications through their valuable suggestions.

Finally, I would like to thank all my friends and family who supported me throughout these years. I am certain that without the effort and encouragement of my parents, Luis and Lucía, and sisters, Carmen and Marisa, I would not have been able to accomplish this goal in my career. I owe you a lot throughout my entire life, thanks for being a reference for me. Thanks also to all my nephews and nieces who helped me to disconnect from work, even from the distance, and to Claudia's family who also supported me along this process.

Last but not least, I would like to especially thank my wife Cláudia, who encouraged me to conduct my PhD studies and always helped me and cheered me up when needed. Thanks for having accompanied me in this adventure in Munich and for always being besides me in the good and hard moments.

ABSTRACT

The ever-growing Internet traffic is pushing operators to continuously upgrade the capacity of their networks by deploying additional energy-consuming network elements, which consequently affect the operational expenditures and greenhouse gas emissions. Thus, energy efficiency is gradually becoming a relevant factor in the operation and planning of telecommunication networks. This Ph.D. thesis evaluates and proposes novel energy-efficient approaches in three design areas of optical transport networks: (1) Network architectures and operation modes; (2) Resilience; and (3) Optical amplifier placements.

Current optical transport architectures, based on wavelength division multiplexing (WDM) technologies, operate with fixed-grid employing a single or a limited set of data rates. The rigid channel spacing constraint and the coarse granularity regarding capacity may lead to an inefficient use of the energy and spectral resources. To overcome these issues, an elastic optical network (EON) with flexible-grid has been recently proposed in the literature to improve bandwidth utilization. Moreover, the adaptive line rate of EON offers new opportunities to improve energy efficiency with respect to fixed-grid WDM networks, which are assessed in this thesis in different scenarios. Additionally, current optical transport networks operate in a static manner and consume constant power independently of the traffic requirements. Future networks will dynamically adapt the capacity to short-term traffic variations. Accordingly, the energy efficiency implications of different modes of operation (i.e. static, semi-static and fully dynamic) are evaluated in this thesis for both EON and fixed-grid WDM architectures.

Protection schemes are commonly implemented by operators to guarantee the necessary service availability. In this thesis, the most common protection schemes are compared first, showing that dedicated protection 1+1 (DP 1+1) is less energy- and spectral-efficient than other schemes such as shared protection (SP) and DP 1:1. Nonetheless, DP 1+1 is still the most deployed one thanks to its short recovery time and simplicity. In order to jointly address the challenges of high service availability and energy efficiency, two novel approaches are proposed and evaluated in this thesis for both EON and fixed-grid WDM architectures: DP traffic-aware power-aware (DP TAPA) and differentiated quality of protection (Diff QoP). DP TAPA is a variation of DP 1+1 that adapts the capacity on the protection path to traffic variations, whereas Diff QoP exploits the heterogeneity of protection requirements of the services/users in the network.

New high-speed optical communications systems have to provide higher throughput with lower energy per bit values than legacy transponders. However, they require higher optical-signal-to-noise (OSNR) values and might be unfeasible for transmissions over long distances. Optical amplifiers play an important role in improving the signal quality (OSNR) to extend the transmission reach in a more energy-efficient manner than regenerations. Until recently, a minimum number of erbium-doped-fiber-amplifiers (EDFAs) were placed in the links. In this thesis, different amplifier placement strategies are proposed with the ultimate goal of improving energy efficiency. Among these strategies, shortening of the length of the individual spans and/or the introduction of low-noise amplification principles like distributed Raman amplification may enable a larger number of higher bit rate transmissions and thus enhance the energy and spectral efficiency of future WDM networks with mixed line rate (MLR).

In summary, the work presented in this thesis proposes and evaluates new techniques that could be applied in the near and medium-term future to enhance the energy efficiency of optical transport networks.

TABLE OF CONTENTS

TABLE OF CONTENTS	ix
CHAPTER 1. INTRODUCTION	1
1.1. Motivation	1
1.2. Thesis objectives and contributions	3
1.3. Overview of the thesis.....	5
CHAPTER 2. THEORETICAL FUNDAMENTALS OF OPTICAL TRANSPORT NETWORKS	7
2.1. Optical transport networks: Overview and evolution.....	7
2.1.1. Telecommunication networks architecture	7
2.1.2. Current optical transport networks.....	8
2.1.3. Future optical transport networks	10
2.2. Physical building blocks	16
2.2.1. Optical fiber	16
2.2.2. Optical transmission/reception.....	18
2.2.3. Optical switching	21
2.2.4. Optical amplification	23
2.3. Network planning and design.....	25
2.3.1. Concepts	25
2.3.2. Traffic.....	26
2.3.3. Physical constraints	26
2.3.4. Current optical transport networks.....	27
2.3.5. Future optical transport networks: Elastic optical networks	30
2.3.6. Resilience schemes	31
CHAPTER 3. OVERVIEW OF ENERGY CONSUMPTION IN OPTICAL TRANSPORT NETWORKS	35
3.1. Energy efficiency	35
3.1.1. Energy consumption in the ICT sector.....	35
3.1.2. Energy consumption in optical transport networks.....	38
3.1.3. Common approaches for improving energy efficiency	39

CHAPTER 4. ENERGY EFFICIENCY OF OPTICAL TRANSPORT NETWORK ARCHITECTURES AND OPERATION MODES	47
4.1. Motivation	47
4.2. Related work.....	50
4.2.1. Energy efficiency on the design of optical transport network architectures.....	50
4.2.2. Energy efficiency on the operation of optical transport networks	52
4.3. General scope	53
4.4. General network parameters	53
4.4.1. Input and output parameters	54
4.4.2. Power consumption models.....	54
4.4.3. Physical layer constraints	55
4.4.4. Network topologies	55
4.5. Energy efficiency of architectures for optical transport networks	56
4.5.1. Motivation and scope	56
4.5.2. Network parameters	56
4.5.3. Methodology	58
4.5.4. Numerical results.....	63
4.5.5. Conclusions.....	72
4.6. Energy efficiency of network operation modes	73
4.6.1. Motivation and scope.....	73
4.6.2. Network parameters	73
4.6.3. Methodology	74
4.6.4. Numerical results.....	79
4.6.5. Conclusions.....	82
4.7. Conclusions of the chapter	83
CHAPTER 5. ENERGY-EFFICIENT RESILIENCE	87
5.1. Motivation	87
5.2. Related work.....	88
5.3. General scope.....	90
5.4. General network parameters	91

5.4.1.	Input and output parameters	91
5.4.2.	Power consumption models	91
5.4.3.	Physical layer constraints	91
5.4.4.	Network topologies	92
5.5.	Energy efficiency of conventional protection schemes	92
5.5.1.	Motivation and scope	92
5.5.2.	Network parameters	92
5.5.3.	Methodology	93
5.5.4.	Numerical results	97
5.5.5.	Conclusions	99
5.6.	Energy efficiency with traffic-aware and power-aware scheme	99
5.6.1.	Motivation and scope	99
5.6.2.	Network parameters	100
5.6.3.	Methodology	100
5.6.4.	Numerical results	101
5.6.5.	Conclusions	102
5.7.	Differentiated Quality of Protection scheme	102
5.7.1.	Motivation and scope	102
5.7.2.	Network parameters	103
5.7.3.	Methodology	105
5.7.4.	Numerical results	110
5.7.5.	Conclusions	114
5.8.	Conclusions of the chapter	115
CHAPTER 6.	ENERGY-EFFICIENT AMPLIFIER PLACEMENT	117
6.1.	Motivation	117
6.2.	Related work	118
6.3.	General scope	119
6.4.	General network parameters	120
6.4.1.	Input and output parameters	120
6.4.2.	Power consumption models	120

6.4.3.	Physical layer constraints	120
6.4.4.	Network topologies	125
6.5.	Energy-efficient selective placement of additional amplifiers.....	125
6.5.1.	Motivation and scope.....	125
6.5.2.	Network parameters	126
6.5.3.	Methodology	127
6.5.4.	Numerical results.....	131
6.5.5.	Conclusions.....	138
6.6.	Energy-efficient amplifier strategies	139
6.6.1.	Motivation and scope.....	139
6.6.2.	Network parameters	139
6.6.3.	Methodology	140
6.6.4.	Numerical results.....	141
6.6.5.	Conclusions.....	142
6.7.	Conclusions of the chapter	143
CHAPTER 7.	SUMMARY AND CONCLUSIONS.....	145
7.1.	Summary of the main contributions and conclusions.....	145
7.2.	Future research challenges	147
LIST OF PUBLICATIONS	149
LIST OF ACRONYMS	151
LIST OF SYMBOLS.....	155
LIST OF FIGURES	159
LIST OF TABLES	163
LIST OF ALGORITHMS	165
APPENDIX A.	ROUTING AND RESOURCE ALLOCATION	167
A.1.	Routing in unprotected scenarios.....	167
A.2.	Resource allocation.....	167
A.2.1.	WDM single line rate.....	168
A.2.2.	WDM mixed line rate	168
A.2.3.	Elastic optical network	169

A.3. Protected scenarios..... 170

 A.3.1. Dedicated protection 170

 A.3.2. Shared protection 171

APPENDIX B. AMPLIFIER PLACEMENTS..... 173

 B.1. Fixed EDFA locations 173

 B.2. Upgrading EDFAs to HREs..... 175

 B.3. Selective placement of additional EDFAs..... 176

 B.4. Selective placement of additional HREs..... 177

BIBLIOGRAPHY..... 179

CHAPTER 1. INTRODUCTION

1.1. Motivation

In the past few decades, Information and Communication Technology (ICT) has become an area of an increasing relevance with a significant impact on our society. The ICT is continuously spreading to more aspects of our professional and private lives, and reaching more population. It changed the manner we communicate with people, get informed, play, interact with companies and institutions, etc. As a simple example of the rapid evolution of ICT, a decade ago a family in a developed country was commonly sharing a personal computer to connect to the Internet at access rates around a few Mbps which allowed users to access a limited set of services (mail, web browsing, chats). Nowadays, several smart phones, computers, tablets, televisions, and other devices can be connected per household. These devices share connections that can reach up to Gbps in Europe, Asia or North America (e.g. Google Fiber in the United States of America [1]). These broadband connections permit the access of high-bandwidth demanding applications like Internet video. In fact, the increased popularity of applications like Internet video or social networks as well as the mobility possibilities (users can be connected almost everywhere) have significantly favored the spread of ICT services in the last years. As shown in Figure 1.1a, the number of Internet users has dramatically increased in the last years. At the end of 2014 more than 3 billion users, representing more than 40 percent of the global population, were connected to the Internet [2].

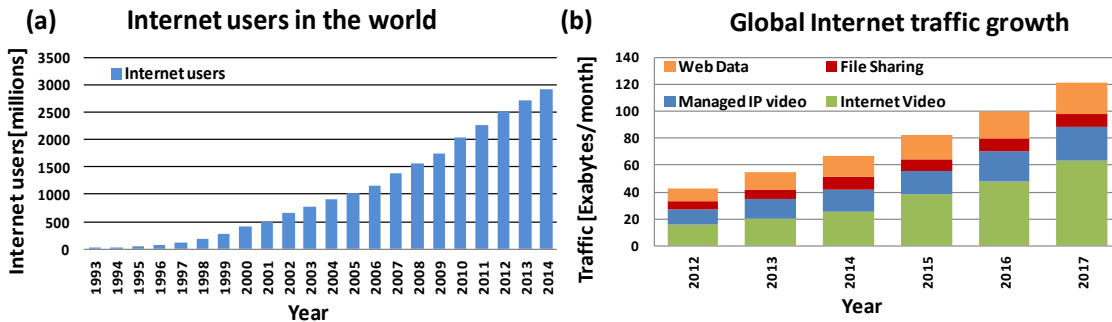

Figure 1.1. (a) Number of connected users to the Internet (based on [2]); and (b) Global Internet traffic growth (based on [3]).

All in all, we are moving towards a society where everyone (and almost everything) will be connected anywhere at any time. As a consequence, the traffic carried in telecommunication networks is rapidly growing and the infrastructure must be ready to meet the new requirements. Different reports from vendors and operators emphasize the enormous growth in traffic experienced by telecommunication networks in the last years and predict a similar trend for the short- and medium-term future. For instance, Cisco predicts in [3] that “Globally, IP traffic will grow 3-fold from 2013 to 2018, a compound annual growth rate of 21 percent” and that the traffic in 2018 will be equivalent to “all movies ever made will cross Global IP networks every 3 minutes”. Other reports also foresee similar trends, one such report from Ericsson [4] predicts that the number of mobile subscriptions will reach up to 5.6 billion by the end of 2019, nearly approaching the total global population. Figure 1.1b presents the predicted traffic growth for the period 2012-2017 [3], which, as observed, it is mainly dominated by Internet video (the most bandwidth-demanding service).

Telecommunication networks are divided into different segments depending on the distances that are covered. The growth in traffic is expected to affect all the parts from the customer premises (home networks), where there are a large number of active elements with moderate power consumption (PC), to the core network, where there are a small number of nodes (core routers) each consuming large amounts of power. In the core network, the traffic transported will be significantly increased as most of the generated data will have to traverse this segment. In particular, the traffic in this segment has already presented approximate average annual growths in the range between 20 and 45 percent depending on the country [3].

In order to cope with the enormous traffic growth, operators need to upgrade their networks. A network capacity upgrade implies an increase in capital expenditures (CapEx) and operational expenditures (OpEx) resulting from, for instance, the deployment of new telecommunication infrastructure, the labor costs, and the related higher PC. The actual PC values of a telecom carrier are difficult to estimate since, besides the power consumed by the devices (optical amplifiers (OAs), optical cross connects (OXC), transponders (TSPs), etc.) there are some additional contributions such as the consumption for cooling the equipment. Nevertheless, there are some works which attempted to estimate the PC. For instance, Lambert et al. [5] projected that in 2012 telecommunication networks were responsible for 2 percent of the worldwide electricity consumption, showing an average annual growth rate of 10 percent since 2007. In fact, telecom operators are becoming one of the major energy consumers in the society. For instance, Telecom Italia was reported to be the Italy's second biggest electricity consumer in 2010 [6], only behind the railway operator. Figure 1.2 presents the forecasted increase of PC in telecommunication networks.

These numbers on energy consumption could be even more significant when considering that more than a single operator is commonly present in a country. Indeed, if traffic continues its current exponential growth and no measure is taken, the energy consumption will become an even more significant problem since energy is a limited and expensive resource. In fact, increasing numbers of energy consumption may seriously impact the financial results of the operators and make it even harder to maintain the already difficult balance between high performance and limited revenues and profit.

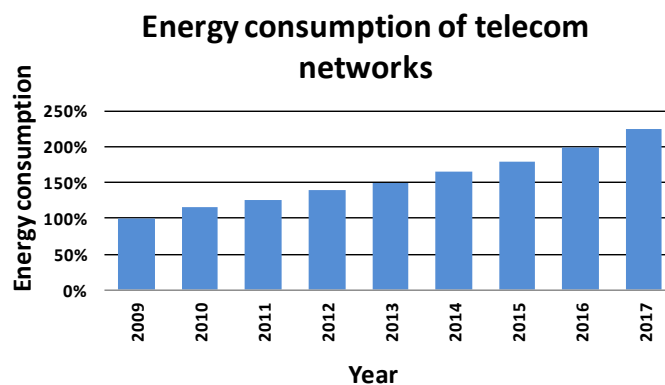

Figure 1.2. Energy consumption growth of telecommunication networks (based on [7]).

Furthermore, higher energy consumption is one of the main contributors to GHG emissions which can have an impact on the global warming. As such, environmental issues are gaining an ever-increasing relevance and are being considered by the telecom operators' policies. Regarding this ecological matter, the ITU estimated in [8] that in 2008, the ICT sector (considering

telecommunications, computing and the Internet, but excluding broadcasting transmitters and receivers) was responsible for the production of 2-2.5 percent of the global GHG emissions, which is similar to the contribution of the entire aviation sector [9]. These emissions are likely to continue to grow in the medium- and long-term if no measures are taken. Accordingly, reducing energy consumption is becoming one of the priorities of the ICT sector, not only as a way to decrease expenses, but also to address the environmental impact of ICT services.

Altogether, the efforts devoted to research and development of energy-efficient mechanisms will be particularly beneficial to ensure the continuous progress of the “Information Society” in a cost-efficient manner while preserving the natural environment. Adopting novel and disruptive energy-efficient approaches will be key to achieving this target.

1.2. Thesis objectives and contributions

The aim of this thesis is to propose and evaluate approaches that could be adopted by the operators to enhance the energy efficiency of the optical layer of the current optical transport network, which will be one of the most affected segments by the future traffic growth. Most of the energy-aware (EA) strategies considered to achieve this target attempt to overcome some of the current inefficiencies in the network design and operation such as:

- **Over-provisioning:** The resources in the core network are commonly assigned in a static manner and with a coarse capacity granularity. For instance, a wavelength or group of wavelengths are assigned to a particular end-to-end traffic demand to cope with potential increases on the peak and average traffic values for several years (without requiring capacity upgrades). Hence, the maximum capacity of the lightpath (LP) may exceed the actual service requirements most of the time leading to a considerable energy waste.
- **Traffic variation and static operation:** Resources are often assigned to cope with the foreseen peak traffic demand. However, real traffic demands vary over time, i.e. the nocturnal traffic demand is usually much smaller than the diurnal one. The way in which the networks are planned today implies that the devices are always active and consuming constant power independently of the actual traffic demand. Therefore, it would be possible to put some unused resources (line cards in nodes or even full nodes) in standby mode during low-traffic periods (sleep-mode) to save energy, or simply assign the resources only on demand basis (i.e. whenever needed).
- **Inefficient spectrum utilization:** The ITU defines a set of channel spacings, 50 GHz being the most widely used in the core network. The fact that the bandwidth of current optical signals (e.g. 40 or 100 Gbps) occupies less than 50 GHz may result in a suboptimal utilization of the spectrum due to the presence of unutilized spectral regions in between channels. This issue may become even more significant with the emerging generations of WDM systems (>200 Gbps). The signals of these high-speed systems will most probably not fit into the 50 GHz slots, requiring the allocation of two contiguous slots and eventually leading to broader spectrum gaps. Overall, an inefficient utilization of the spectral resources may lead to the deployment of a larger number of fibers with the consequent increase in energy consumption (e.g. activation of more OAs).
- **High availability:** High availability is commonly achieved by resilience schemes. Among the different resilience schemes, DP 1+1 is the most widely used thanks to its shortest recovery time (RT). DP 1+1 relies on the allocation of redundant resources, i.e. data are transmitted along two independent paths simultaneously, so that in case of failure in the working path (WP) it would still be possible to receive the information conveyed over the

protection path (PP). The reservation of duplicated spectral resources and the installation of additional energy-consuming devices have negative impacts on spectral and energy efficiency, respectively.

- **Transparent reach:** Higher-speed transmission systems, such as 400 Gbps, will be key in future network deployments, but require a higher optical signal to noise ratio (OSNR) than current systems to successfully recover the information at the receiver. The transmission reach limitation of these systems could be overcome by OEO regenerations at the intermediate nodes, but entailing a significant increase in cost and energy consumption.

In this thesis, different approaches are proposed and evaluated to exploit the previously mentioned issues and achieve more flexibility in the design and operation of optical transport networks with the final goal of enhancing energy efficiency. It is worth mentioning that optical network design is complicated and needs to be balanced among a set of different metrics, e.g. cost, energy, resilience, performance measures, scalability, etc. These trade-offs must always be taken into account in any novel energy-efficient approach. In particular, this thesis has been devoted to the evaluation of the following energy-efficient approaches:

1. **Energy-efficient network architectural design:** Evaluate the potential advantages in terms of energy efficiency that novel network architectures may offer with respect to the conventional fixed-grid WDM technologies. In particular, the advantages of EONs are extensively studied. The EON paradigm has been recently proposed to achieve a more efficient and flexible utilization of the spectral resources and enable the employment of channels (“super-channels”) beyond 100 Gbps. The analysis is carried out while considering both static and dynamic operation of the network.
2. **Energy-aware network operation:** Current optical transport networks operate in a static and rather inflexible manner. The advantages of exploiting the traffic variations by adapting the transmission to the current demands, or even establishing connections only when needed, in a bandwidth-on-demand (BoD) approach are evaluated.
3. **Energy-aware protection schemes:** Energy-aware resilience schemes are proposed and evaluated to enhance the energy efficiency of the current DP 1+1 scheme. The novel protection schemes can exploit the traffic variations over time and the heterogeneity of availability requirements (assuming that not all services need the same level of protection).
4. **Energy-efficient amplifier placements:** OAs play essential roles to improve the signal quality in core networks and enable the transmissions over long distances of several hundred kilometers. Commonly, these amplifiers are placed in spans of around 80 km to compensate the loss that the signals suffered along the transmission over the fiber. Novel amplification strategies are proposed and studied with the objective of optimizing the overall energy efficiency.

Algorithms for these EA approaches have been developed and tested by means of simulations using realistic traffic information over realistic long-haul networks of European operators.

1.3. Overview of the thesis

The remaining parts of this thesis are organized as follows.

In *Chapter 2*, an overview of the evolution of optical transport networks is given. This chapter gives an insight into the main concepts, building blocks and network design strategies that will be employed in the following chapters.

In *Chapter 3*, the current situation of telecommunication networks in terms of energy consumption and environmental issues is analyzed. Moreover, the latest research on energy-efficient optical transport networks and main activities are surveyed, presenting the different levels at which energy consumption can be reduced.

Chapter 4 compares different network architectures and operation modes in terms of energy efficiency. Specifically, the potential advantages of EON with respect to conventional WDM with single line rate (SLR) and mixed line rate (MLR) are assessed by simulations based on the proposed EA routing and resource allocation algorithms. Furthermore, more flexible and dynamic operation modes are evaluated to overcome the inefficiencies due to the static operation of optical transport networks. In particular, a traffic-aware power-aware (TAPA) approach is proposed to exploit the traffic variations over the day and reduce consumption during low-traffic periods (e.g. at night). A more disruptive scenario, where connections are only provisioned when requested (BoD) is also evaluated in terms of energy efficiency for different network architectures.

In *Chapter 5*, the conventional protection schemes such as dedicated and shared protection are first compared in terms of energy efficiency for EON and fixed-grid WDM networks. Based on the conclusions gathered from this preliminary evaluation, several novel protection schemes are proposed and evaluated to overcome the inefficient resource utilization of DP 1+1 without sacrificing reliability. These schemes consider the variation of traffic along the day (DP TAPA) as well as the heterogeneous protection requirements of the different users/services that coexist within the network (Differentiated quality of protection– Diff QoP).

In *Chapter 6*, different amplification strategies are evaluated to improve the overall energy- and spectral efficiency of the network with respect to the conventional scenario where OAs are deployed in spans of approximately 80 kilometers (span lengths may vary between 60 and 110 km depending on the network). In particular, the possibility of placing additional in-line OAs at intermediate locations in the links and/or using new amplification principles such as distributed Raman amplification are assessed in terms of energy and spectral efficiency.

Finally, *Chapter 7* concludes this dissertation. The main conclusions and learned lessons from the work carried out in this thesis are summarized, by emphasizing the main contributions, discussing the potential applicability of the proposed approaches, and pointing out the next steps and the remaining open issues for future energy-efficient research.

CHAPTER 2. THEORETICAL FUNDAMENTALS OF OPTICAL TRANSPORT NETWORKS

2.1. Optical transport networks: Overview and evolution

2.1.1. Telecommunication network architecture

Telecommunication networks are composed of different segments or domains as depicted in Figure 2.1. As shown in the figure, these segments are classified according to the distance from the end user.

The home network is the private network to which the users connect first, it could be wired (Ethernet, power line communications) or wireless (Wi-Fi). Then, the home networks are connected to the access network, which commonly covers distances of a few kilometers and performs as an interface to get connected to the next network segment (the metro part).

The access network could also be wired/fixed (fiber to the home (FTTH), advanced digital subscriber line (ADSL), etc.) or wireless (mobile network technologies such as universal mobile telecommunications system (UMTS), long-term evolution (LTE), etc.). Copper pair-based access technologies like ADSL have started to be replaced by fiber-based technologies wherever it is possible and affordable according to the number of potential users. The access networks then connect to a wired metro network which usually covers a metropolitan area with distances of a few hundred kilometers (the so-called metro network).

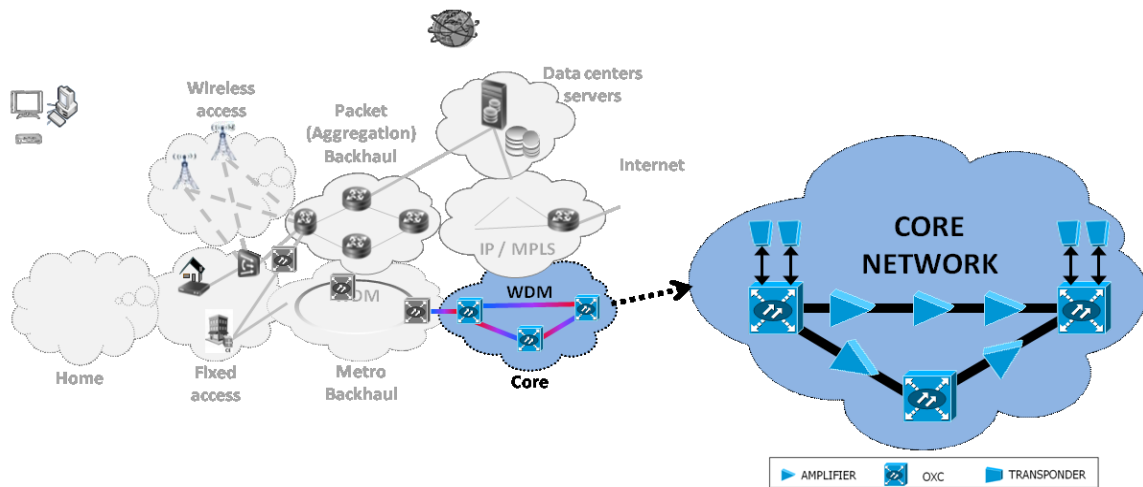

Figure 2.1. Telecommunication networks architecture and segments.

The following segment is the metro segment which is in charge of aggregating the different user flows and interconnecting them through the core network or to the data centers where the content is stored. In fact, the metropolitan networks are interconnected through the core or backbone network, which can cover an entire country or even a continent with end-to-end distances from several hundred to several thousand kilometers. These networks transport the aggregated data of a large number of individuals and therefore they deal with higher capacity (e.g.

several Gbps). Commonly the core network comprises a set of large nodes which correspond to major population areas (e.g. cities), and are interconnected by high-capacity fiber links (also to other operators' networks).

Moreover, current networks are conceptually composed of different layers according to the Open Systems Interconnection (OSI) network model. Each layer is responsible for different tasks, and this thesis is particularly devoted to the physical (optical) layer of the core transport part.

2.1.2. Current optical transport networks

2.1.2.1. WDM networks: Types and ITU's role

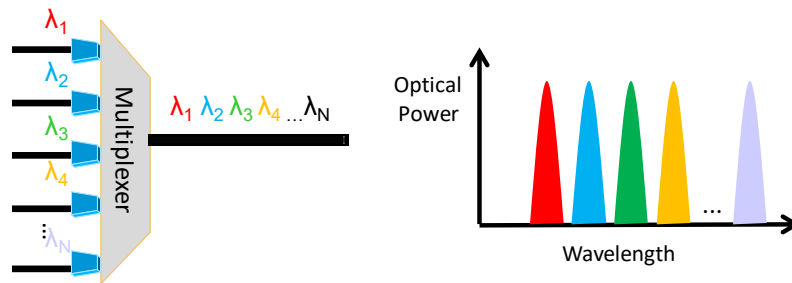

Figure 2.2. WDM concept – Multiplexer/De-multiplexer (MUX/DEMUX) and optical spectrum.

The current operation of optical networks is based on the transmission of light pulses over the optical medium, which are successfully detected at the receiver end. In order to expand the effective capacity of the fiber, transport networks leverage on wavelength multiplexing to exploit the useful bandwidth of the fiber medium. This technique is called WDM and allows several signals to be transmitted simultaneously on the same fiber while switched and terminated independently thanks to their different frequency location on the spectral band. Each signal is centered on a different wavelength (or color) and will be multiplexed by a multiplexer (MUX) for the transmission over the fiber and de-multiplexed by a de-multiplexer (DEMUX) at the other end, as depicted in Figure 2.2.

The International Telecommunications Union- Telecommunications Standardization Sector (ITU-T¹) defines different wavelength bands as presented in Table 2.1. Figure 2.3 depicts the useful spectrum and attenuation at different wavelengths in a single mode fiber (SMF). As can be seen, each wavelength band presents different attenuation, which must be taken into account for selecting the appropriate spectrum ranges for the optical transmission. A transmission window of around 100 nm can be found around 1310 nm (O-band) with attenuation values below 0.5 dB/km. A second transmission window is centered at 1550 nm with a similar size and offering losses below 0.2 dB/km (i.e. equivalent to 20 dB of attenuation for a transmission distance of 100 km). In fact, the most common used band for long-haul transmission is the C-band thanks to its low attenuation and the possibility of using EDFAs to maintain the signal quality. The other bands are mainly used for metro applications. In the E-band there can be a water peak which presents very

¹“The International Telecommunication Union (ITU) is the United Nations specialized agency in the field of telecommunications, information and communication technologies (ICTs). The ITU Telecommunication Standardization Sector (ITU-T) is a permanent organ of ITU. ITU-T is responsible for studying technical, operating and tariff questions and issuing Recommendations on them with a view to standardizing telecommunications on a worldwide basis.” [10]

high losses in SMFs. Special type of fibers, known as full spectrum fibers, can exhibit reduced water peak losses and extend the useful optical spectrum range.

Table 2.1. Frequency bands.

Fiber spectral bands		
Band Name	Wavelength range	Description
O-band	1260 – 1360 nm	Used for PON upstream
E-band	1360 – 1460 nm	Water peak band
S-band	1460 – 1530 nm	Used for PON downstream
C-band	1530 – 1560 nm	Lowest attenuation, compatible with EDFAs
L-band	1560 – 1630 nm	Low attenuation

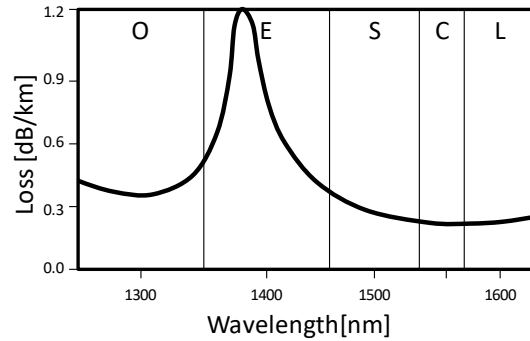

Figure 2.3. Loss in a single-mode-fiber.

The ITU-T defines relevant recommendations to allow for the interoperability among the equipment manufactured by different vendors. In the ITU-T recommendations two types of WDM are defined: Coarse WDM (CWDM) and Dense WDM (DWDM). Both technologies are basically based on the same concept but differ in the covered frequency range, channel spacing and total number of channels:

- DWDM:** Channels in DWDM are tightly packed in the so called ITU-T C-band (1530 to 1560 nm), which is the spectrum region that offers the lowest attenuation. The G.694.1 recommendation [10] specifies a frequency grid anchored to 193.1 THz, corresponding to a wavelength of 1552.52 nm, which roughly covers 4 THz around this “anchor” as shown in Figure 2.4a. In the Rec. G.694.1, several channel spacing values (also known as ITU-T grids) are defined. The most widely adopted channel spacings in DWDM are 50 GHz and 100 GHz, but the Rec. G.694.1 was updated in 2012 to include the concept of frequency slot (FS), considering a minimum bandwidth unit of 12.5 GHz for flexible-grid networks. The total number of channels varies according to the adopted ITU-T grid (e.g. 40 with 100 GHz, 80 with 50 GHz, etc.). The large number of channels allows for high scalability in current networks. Additionally, the entire spectrum range (C-band) can be amplified by EDFAs to extend the transmission distance, so that DWDM is often used in long-haul networks.
- CWDM:** The ITU-T Recommendation G.694.2 [11] specifies channels of 20 nm spacings from 1470 nm to 1610 nm (i.e. upper part of the S-band, the entire C-band and the lower part of the L-band). As shown in Figure 2.4b, CWDM covers a significantly broader spectrum than DWDM. However, the number of channels is significantly smaller with CWDM, i.e. 8 or 10 channels depending on whether low water peak fiber is used or not. In contrast to DWDM, the unavailability of commercial amplifiers for all the channels makes it more suitable for metro/access network applications, since its applicability for long-haul communications would need to rely on many OEO regenerations.

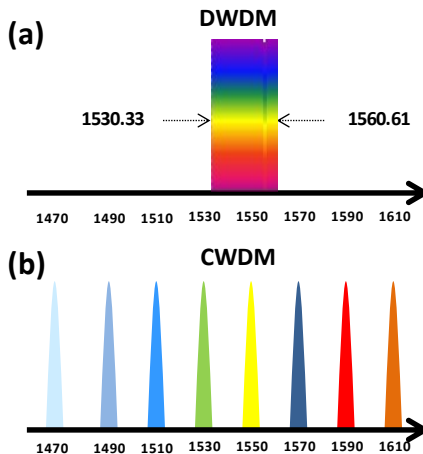

Figure 2.4. Comparison of optical spectrum utilization in: (a) DWDM; and (b) CWDM.

2.1.2.2. Operation of WDM networks

The optical layer of the core networks deals with high capacity traffic demands (of up to several Gbps) composed of the aggregated traffic coming from multiple users. These core nodes include optical transponders (TSPs), which are responsible for mapping the client signals (based on Synchronous Digital Hierarchy (SDH), Gigabit Ethernet (GbE), etc.) into appropriate optical transport network (OTN) containers (i.e. optical data units) over a specific WDM channel. All the WDM channels are subsequently multiplexed and the composite signal is launched into the optical fiber to be transmitted. At intermediate nodes, the channels can be passed-through towards their final destinations, or regenerated to improve the signal quality in the regenerator (REG). At the end nodes, the channels can be added/dropped when a client data link is originated/terminated at that node. These processes are performed by OXCs, also known as reconfigurable optical add/drop multiplexers (ROADMs). OAs can be used along the fiber links to recover the power of the signal and thus increase the transmission distance. The main operation and functionalities of the optical network elements, shown in Figure 2.1, are explained in further detail in Section 2.2.

A connection in the optical layer is referred to as a LP. The establishment of a LP implies the selection of the appropriate route and wavelength channel, deploying the TSPs at the terminal nodes according to the traffic requirements, and setting up the appropriate cross-connections at the intermediate nodes (i.e. OXCs). In current networks, once a LP is established it usually remains active for a long period of time (even up to several years) over the same route and assigned wavelengths. The main concepts about network planning are detailed in Section 2.3.

2.1.3. Future optical transport networks

This section explains some of the challenges of current optical transport network as well as some of the main directions for future research.

2.1.3.1. Challenges

The increasing popularity of Internet services in all the aspects of our lives is imposing new challenges that must be addressed when designing future core networks. Some of the main challenges are listed below with a potential foreseen solution:

1. **Traffic growth**

- *Problem description:* As mentioned in the introduction of this thesis, the exponential traffic growth (compound annual growth rates of approximately 35 percent per year [12]) is forcing operators to increase the capacity of their networks to meet the requirements of their customers. Network traffic volumes are growing at such significant rates that the capacity offered by current technologies will soon become insufficient to provision the services in a cost-effective manner. First, the potential capacity of the network might not be efficiently exploited if the actual traffic demand is lower than the fixed transmission rate of the TSP. Thus, there is an interest in improving the spectral efficiency (i.e. data that can be transmitted per spectral unit) and a more adaptive transmission. A second problem comes from keeping the commonly adopted ITU-T channel spacings of 50 GHz, which may lead to an inefficient utilization of the spectral resources. This problem might become more critical by the generations of transmission technologies beyond 100 Gbps, whose signal bandwidth is supposed to be larger than 50 GHz grid.
- *Potential solutions:* Advanced transmission equipment with higher spectral efficiency, including digital signal processing (DSP) at the transmitter side and more complex algorithms at the receiver side is needed. It is also expected that the equipment will be capable to adjust the transmission rate to the demand. Furthermore, in order to address the need for a flexible resource allocation, EONs have been proposed to replace conventional fixed-grid WDM networks. EONs operate over 12.5-GHz frequency “chunks”, with a variable number of these chunks being assigned to a channel as a function of the bandwidth requirements.

2. **Need for cost- and energy-efficient solutions**

- *Problem description:* A network capacity upgrade implies CapEx and OpEx resulting from, for instance, the deployment of new telecommunication infrastructure and the related higher PC. As mentioned earlier, environmental issues will also arise due to the increased energy consumption. Therefore, reducing cost and energy consumption is key for operators to achieve higher profit margins, or at least maintain the current ones.
- *Potential solutions:* Recent advances on technologies such as new generations of optical transmission equipment commonly allow for reducing the cost and energy per bit. Besides, achieving a more efficient utilization of the limited resources (e.g. spectrum) and the simplified management tasks may also help in reducing the overall cost. Many novel approaches are being proposed to overcome these issues, as presented in Chapter 3.

3. **Adaptive and flexible network**

- *Problem description:* Traffic varies depending on the time and location. The traffic peak is normally observed during a couple of hours, while traffic at night might be significantly lower since less people access the network. Moreover, user location also influences the traffic load. For example, traffic is mainly generated on company premises during working hours while the rest of time users mainly connect from more residential areas.
- *Potential solutions:* Make the optical layer operation more dynamic and adaptive, so that the transmission could be adapted to the traffic variations.

4. **Heterogeneous requirements**

- *Problem description:* Services for clients with different traffic requirements have to coexist in the network. Conventional WDM networks are commonly operated assuming SLR transmission (i.e. the same transmission equipment is used for all the connections). When moving to higher speed communications systems, keeping the SLR approach may

imply that the fiber capacity is exceeded in many cases, leading to capacity and energy waste (e.g. requiring several parallel fibers to cope with the capacity requirements).

- *Potential solutions:* MLR can be a short-term solution to better suit the heterogeneous traffic demand requirements. However, for higher traffic heterogeneity levels, MLR is not efficient due to the limited number of available line rates (LRs). EONs may enable enhanced efficient network resource utilization through a finer adjustment of the channel capacity to better match the actual service demand.

5. **Reliability and high service availability**

- *Problem description:* An increasing number of indispensable services relies on the telecommunication infrastructure, so that making the network resilient against common failures is a must for operators. Resilience is commonly achieved by the dedicated protection 1+1 (DP 1+1) scheme. DP 1+1 is a reliable and secure solution (i.e., it provides the fastest possible recovery), but relies on the provisioning of many redundant resources, leading to low network utilization in many cases.

- *Potential solutions:* New protection schemes which could make a more flexible usage of the network resources, as well as differentiating the traffic according to the service availability levels could help reducing resource redundancy while meeting the service level agreement (SLA) terms.

6. **Reconfigurability**

- *Problem description:* WDM legacy networks lack reconfiguration flexibility and need on-site manual interventions for any service modification (e.g. if a channel needs to be added/dropped at a different location or service must be recovered due to failures).

- *Potential solutions:* Intelligent optical networks following meshed architectures and the introduction of reconfigurable optical switches are essential to address this challenge. End-to-end services over these networks can be created and modified in a dynamic manner thanks to a network control plane and a flexible network management system. The new capabilities will also provide better exploitation of fiber resources and increased survivability, since service restoration can be done “on the fly”.

2.1.3.2. Future directions for optical transport networks

The previously mentioned challenges are being considered for developing the future optical transport networks. Overcoming these challenges will be possible by combining the research carried out in different areas such as at the component, device or networking levels. This section gives an insight into the main changes envisaged in the optical transport architectures, while particular future research directions of each building block of WDM networks (TSPs, switching elements, fibers, and amplifiers) are described in Section 2.2.

Conventional DWDM networks with channel bit rates of up to 100 Gbps frequently operate with the ITU-T grid of 50 GHz [10]. The envisioned advances at the system level will shortly bring solutions allowing for transmission rates beyond 100 Gbps to the market. The first implementations (e.g. 200 or 400 Gbps) will be compatible with the current ITU-T grid of 50 GHz and offer enhanced spectral efficiency, energy efficiency, and tolerance to physical impairments. However, the signal bandwidth of future DWDM systems (e.g. 400 Gbps or 1 Tbps) will most likely be wider than 50 GHz and impose the utilization of more than a single ITU-T slot. Therefore, to fully exploit the potential spectral efficiency advantages provided by these systems, changes in the current spectrum allocation strategies are desired.

Recently, EONs which consider the division of the optical spectrum into frequency units smaller than 50 GHz, the so-called frequency slots (FSs), are becoming more relevant. EONs are also referred to as flexible-grid networks. As discussed earlier, the ITU-T Recommendation G.694.1 [10] has been modified to include flexibility and define the central frequencies (6.25 GHz granularity) with channel bandwidths multiples of 12.5 GHz. The flexible-grid operation permits a much more flexible utilization of the spectrum by assigning a variable number of FSs to each service demand. Thus, significant spectral resources can be saved and assigned to future high-speed channels beyond 100 GHz. In fact, the key point is to not only deploy new transmission technologies with higher spectral efficiency, but also to make better use of available bandwidth. Flexibility can be exploited by multicarrier WDM transmission as well as by orthogonal frequency-division multiplexing (OFDM). For instance, 400 Gbps transmissions based on dual carrier 16-QAM can fit into six contiguous slots of 12.5 GHz (75 GHz) instead of two ITU-T grid slots of 50 GHz (100 GHz), so that the spectrum occupancy can be reduced. Moreover, the concept of super-channels with capacities of up to several Tbps is realized by the allocation of several contiguous FSs. The potential savings on spectrum can be observed in Figure 2.5 which compares the conventional allocation of channels with fixed- and flexible-grid. Thanks to the finer spectrum granularity, 75 GHz are available for the allocation of other channels. Consequently, a relevant increase of useful capacity can be obtained with respect to current DWDM deployments where the allocation is rather rigid and the number of channels is fixed (between 40 and 80 channels in practical deployments depending on whether 100 GHz or 50 GHz spacings are employed).

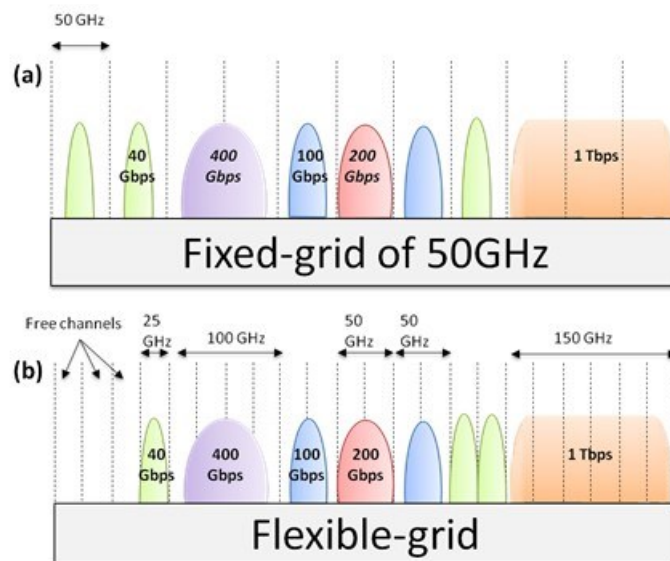

Figure 2.5. Channel allocation with (a) Current ITU-T fixed grid of 50 GHz; and (b) Flexible-grid with a FS of 25 GHz.

The EON paradigm will certainly change the manner in which current optical transport networks operate. Indeed, EON combined with some other supporting technologies (e.g. software defined networking) attempt to address most of the previously mentioned challenges for core networks. These changes will range from the extension of overall network capacity to the dynamic optimization of resources and lower PC and cost.

The operation of EON is based on the introduction of two novel devices which are currently under research: the bandwidth-variable transponder (BVT) and the bandwidth-variable OXC (BV-OXC) using 12.5 GHz granularity instead of 50 GHz. The technology of choice for the transmission

of super-channel is still under consideration. Major system vendors are currently working on multiple approaches, trying to identify their main benefits and drawbacks (i.e. technical feasibility, economic aspects, potential for evolution). Some of the future directions for these elements are detailed in Section 2.2. These devices can work with different optical signal bandwidths, but can also be compatible with the existing ITU-T 50 GHz grid network architectures by assigning several FSs to make it compatible with the ITU-T grid (e.g. four FS of 12.5 GHz will make the channel compatible with networks operating with the ITU-T grid of 50 GHz). This can indeed enable a smooth migration from conventional DWDM networks to EON. In fact, different domains can be created depending on whether the installed equipment is compliant with fixed- or flexible-grid as shown in Figure 2.6b.

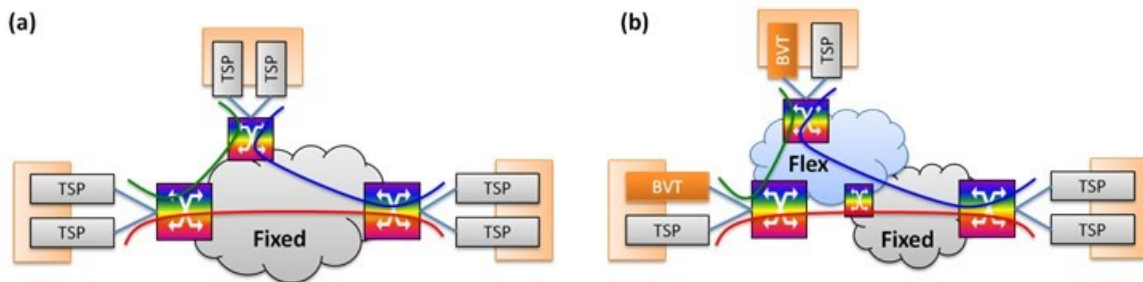

Figure 2.6. Example of network operation with: (a) Conventional fixed-grid network; and (b) Two different domains: one with fixed-grid and another with flexible-grid.

Other than the spectral-efficiency benefits, EON can bring other interesting features for the operation of future networks:

- **Reduced over-provisioning levels:** A fine adjustment of the channel capacity to the actual traffic demand is provided, allowing the optical network to handle more services. The improvements in spectral efficiency will also allow for reducing cost and increasing energy efficiency (e.g. smaller number of fibers may help reducing the number of energy-consuming devices that are deployed in the network).
- **Dynamic adjustment on performance, network resources and PC:** A BVT allows for selecting the signal format (modulation, symbol rate, forward error correction (FEC), etc.) best suited to the network conditions. This can be exploited to reduce the use of spectral resources, PC and also to adjust the modulation format (MF) to the path distance (i.e. distance-adaptive modulation).
- **Improved network resilience level:** Resilience can be enhanced thanks to the bigger number of feasible routes given by the distance-adaptive modulation functionality (i.e. possible adaptation of the MFs to the path length). This may reduce blocking ratios and translate into global capacity augments (i.e. more protected services transported in the network), which can eventually be beneficial to enhance energy efficiency.
- **Enabler for future WDM systems beyond 100 Gbps:** As mentioned previously, the optical signals of a super-channel could be transported as a single entity thanks to the flexible-grid functionality. This avoids the need for concatenation of multiple lower speed individual signals, which can simplify the network management and reduce the switching energy consumption.
- **Logistic advantages and potential economies of scale.** The deployment of BVTs would strongly reduce the network spares inventory, as a single element could be employed for different rates and network conditions. Even though the maximum BVT capacity may

exceed the capacity requirements in many cases, economies of scale would cause BVT to reduce cost over time.

- **Energy efficiency.** The flexibility given by EON and its variable transmission rate adaptation may enhance the energy efficiency of the network. The potential advantages of EON in terms of energy efficiency are analyzed in Chapter 4.

Despite the potential benefits of EON, this architecture implies changes in different fields such as control plane, resource allocation algorithms, traffic grooming, and survivability mechanisms. These issues must be carefully assessed and will certainly determine the success and applicability of this technology in real deployment scenarios.

The topic of EON is relatively new, but it has been extensively investigated over the last few years. For instance, some surveys have been published summarizing the most recent work, as well as the main enablers and potential advantages that can be achieved with an EON such as [12-15]. This concept has been experimentally demonstrated in several publications such as [16], where the authors showed the first demonstration of elastic transmission of channels with bit rates from 40 to 400 Gbps. In addition, the commercial availability of enabler devices such as BVT and flexible-grid OXC is becoming a reality.

The adoption of EON can also introduce some novelties in the survivability mechanisms in optical transport networks. In particular, bandwidth elasticity can be exploited to reach a better utilization of the spectral resources in EON by the application of bandwidth squeezed restoration [17] and intelligent backup path sharing [18].

2.1.3.3. Other research directions

Besides the EON paradigm, there are several emerging topics which are being investigated for their potential application, mostly in the long-term, in optical transport networks. Some of these approaches are:

- **Space Division Multiplexing (SDM):** This technology relies on the idea of mapping the data into different pipes to be commonly transmitted over the same fiber. In order to do so, different propagation modes can be considered in a multi-mode fiber (MMF) or fibers with multiple cores can be used. Each “flow” will then be transmitted over a different mode or core. This concept is still under research, but the need of deploying special fibers (currently SMFs are used) makes its possible application to the transport layer more difficult. New transmitters, receivers and amplifiers also have to be developed. SDM could be combined with the EON paradigm to further extend the capacity of the network [19].
- **Software defined networks (SDN):** This concept assumes that the control plane (software) will be decoupled from the physical topology (hardware), while in current networks both planes are coupled together. SDN is envisioned to revolutionize the network by providing enhanced flexibility and more efficient utilization of resources, which may result in significant advantages for operators and users. The application of SDN in an EON architecture is promising to achieve full network reconfigurability and adaptation to different conditions as described in [20].
- **Optical packet switching (OPS) and optical burst switching (OBS):** Under research for several years to overcome the resource utilization problems of the currently used approach: optical circuit switching (OCS). OBS is an intermediate step between OCS and OPS (similar to IP operation), where control messages are sent out-of-band in a different optical channel.

- **Maximize fiber capacity:** In addition to the increase on spectral efficiency enabled by the new generations of TSPs, mechanisms are being developed to maximize fiber capacity such as the extension of the operating wavelengths to the C+L bands (wavelength range between 1530 nm and 1625 nm).

2.2. Physical building blocks

The operation of an optical transport network relies on the availability of a set of elements which are described in this section from a high-level perspective in order to understand the main principles of the devices that will be later referred in the following chapters. Data transmission over the optical fiber and switching are the key tasks performed by the transport networks. Optical amplification is also essential for long-haul networks. Together, the main elements of an optical transport network are presented in Figure 2.7: OA, OXC, TSP and optical fiber.

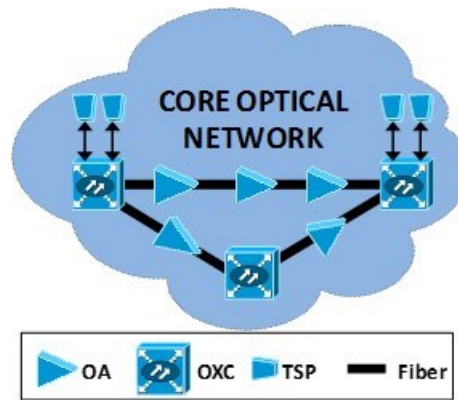

Figure 2.7. Main building blocks of the core optical network.

2.2.1. Optical fiber

2.2.1.1. Principles and types

The optical fiber is the medium used for the transmission in optical transport networks. It is a transparent guide with a size thicker than a human hair and made of glass (e.g. silica) or plastic. An optical fiber is composed of a core surrounded by a cladding material which has a lower refractive index n (i.e. the refractive index describes how the light propagates over the fiber and is obtained by the ratio between the speed of light c and the phase velocity of the medium v). It can act as a waveguide to transmit light between the two ends of the optical fiber by the principle of total internal reflection at the core-cladding interface, as depicted in Figure 2.8.

An optical fiber offers indeed many advantages over metal wires such as copper. It is immune to electromagnetic energy interference and generally suffers much lower losses than copper, which permits longer distance transmissions. Also, it offers much broader bandwidth and is cheaper than copper.

There are different types of fiber depending on the number of supported propagation modes, namely SMF and MMF. The former allows for the propagation of one mode and it is the most widely used (ITU-T G.652). The latter allows for the propagation of multiple modes and has a much broader core (50 or 62.5 μm compared to the approximate 9 μm of SMF). For long-haul optical communications SMF is mainly used, but MMF is being extensively investigated for its long-term application in the so-called SDM techniques. In real deployment scenarios, optical cables (i.e. tubes containing a bundle of SMF fibers) are often deployed.

Furthermore, special SMF fibers have been developed to meet specific purposes such as the low water peak fiber (LWPF), dispersion shifted fiber (DSF) and non-zero dispersion shifted fiber (NZDSF).

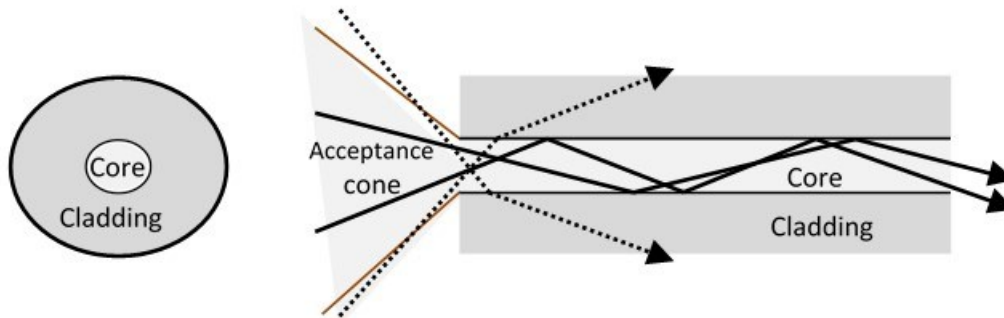

Figure 2.8. Optical fiber parts and principle of internal reflection.

2.2.1.2. Physical impairments

The transmission over optical fibers is affected by a set of physical impairments which will eventually diminish the distance that a LP can cover:

- **Attenuation:** The attenuation in a fiber results in a wavelength dependent power loss and is assumed to be constant. The loss of a SMF is presented in Figure 2.3 and, as can be seen, strongly depends on the wavelength band being used. Commonly the C-band (1530-1560 nm) is used for long-haul transmission in DWDM, which is the part of the optical spectrum offering the lowest attenuation and where EDFAs can be employed to improve the signal quality. SMF (ITU-T G.652) offers zero dispersion at 1310 nm and the lowest attenuation at 1550 nm (approximately equal to 0.20 dB/km).
- **Dispersion:** Dispersion broadens the optical pulses and makes them develop variation in frequency, which may affect the signal of neighboring channels causing inter-symbol interference. Dispersion may in fact deteriorate the signal and reduce the transmission distance. This effect in optical fibers is caused by the material dispersion and the waveguide dispersion. Material dispersion arises from the fact that the refractive index at different wavelengths is slightly different and consequently signal components transported over different wavelengths may travel at slightly different speeds. On the other hand, waveguide dispersion is dependent on the shape and refractive profile of the fiber core and cladding. As the main contributors to dispersion depend on the composition of the material and the geometrical shape of the waveguide, it is possible to construct different dispersion profiles to meet specific requirements. For instance, a DSF (ITU-T G.653) is defined to achieve zero dispersion in the region of 1550 nm.

The propagation of the signal over the fiber may be affected by dispersion in different ways. For instance, modal dispersion will occur in MMF when different modes travel at different speed along the fiber. Chromatic dispersion is the phenomenon by which different spectral components of a pulse travel through the fiber at different velocities and arrive at different times at the receiver. Chromatic dispersion occurs due to the material and waveguide dispersion phenomena. Finally, polarization-mode dispersion (PMD) may occur when the shape of the core is not perfectly circular, which causes that the different polarizations do not propagate at the same speed.

In addition to the linear effects, when an optical pulse propagates over the fiber, it may also suffer from non-linear effects which may affect the successful recovery of the information at the receiver and must be taken into account at the system level. Non-linear effects may arise due to two phenomena. The first one is given by the interaction of light waves on phonons (molecular vibrations) in the silica medium, and the second due to the dependence of the refractive index n with the intensity of the applied electrical field. Some of the main non-linear effects that may deteriorate the signal are the self-phase modulation (SPM), four-wave mixing (FWM) and cross-phase modulation (XPM). More details about these phenomena and their influence can be found in reference [21]. However, it is worth mentioning that as long as the optical power within an optical fiber is kept not too high, the fiber can be treated as a linear medium and that most of the penalties induced by non-linear effects can be neglected (commonly some additional margin is considered to account for potential penalties due to non-linear effects).

2.2.2. Optical transmission/reception

The transponder (TSP) is an essential element for the operation of core networks as it is responsible for the generation and reception of the optical signal. A TSP transmits and receives an optical signal at a specific ITU-T grid wavelength. TSPs are usually wavelength tunable and can be adjusted to the chosen wavelength, that is, the one selected in the wavelength assignment phase (explained in Section 2.3). There are many parameters to characterize a TSP, but, from a network planning perspective, the line rate (LR), transmission reach, and power consumption (PC) are some of the most important. The hardware architecture of the TSP may vary according to the generation, LR and MF, among other factors.

2.2.2.1. Current WDM Transponders

Each signal is assigned a fixed channel slot in the C-band (e.g. 50 GHz slot) from the ones defined by ITU-T in the Rec. G.694.1. Until some years ago, the maximum capacity of a single optical signal was limited to 10 Gbps. Therefore, a maximum capacity of around 800 Gbps could be transmitted per fiber link (assuming that the 80 channels were occupied).

The traditional systems used for 10 Gbps are based on a simple mechanism known as OOK (ON/OFF Keying) as shown in the constellation of Figure 2.9a. This MF assumes a simple technique where the data signals are injected to an optical modulator. A logical “one” causes a laser light to traverse the modulator (ON), while with a logical “zero” the laser light does not get out of the modulator block (OFF). At the other end, the receiver determines whether a “zero” or a “one” was transmitted according to the detected light intensity at a photodiode. The information in 10 Gbps systems is only contained in the carrier amplitude. However, for speeds above 10 Gbps, the modulation formats (MFs) exploit more than a carrier parameter to be able to convey more information in a single channel such as:

- **Carrier phase:** Phase shift keying (PSK) formats carry the information in phase. Figure 2.9b shows the signal constellation for quadrature phase shift keying (QPSK)
- **Carrier amplitude and phase:** Quadrature amplitude modulation (QAM) formats use both the amplitude and the phase to convey the information. For instance, the signal constellation for 8-QAM is presented in Figure 2.9c.

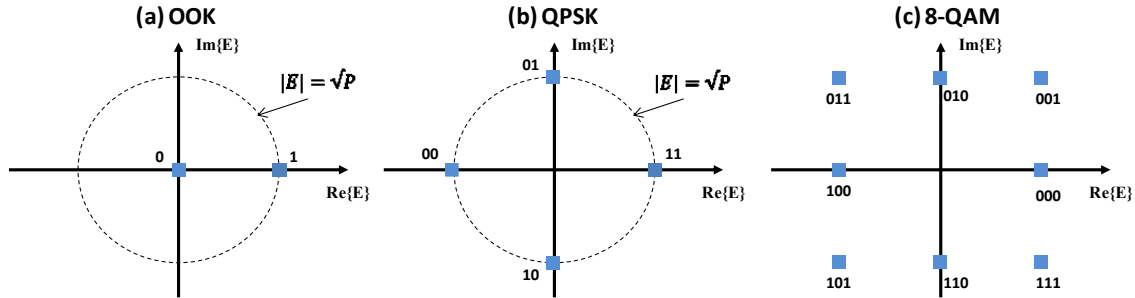

Figure 2.9. Signal constellations for different modulation formats: (a) OOK; (b) QPSK; and (c) 8-QAM.

In most recent generations of optical communications systems (e.g. beyond 40 Gbps), the previous MFs are commonly combined with polarization multiplexing to further extend the capacity of an optical channel. The data stream is actually divided into two parallel flows, which are then transmitted over two optical carriers with different orthogonal polarization state (x-polarization and y-polarization). This method is commonly referred to as polarization division multiplexing (PDM) or dual polarization and permits to double the spectral efficiency per channel.

In fact, TSPs can be differentiated by the detection method employed: direct or coherent detection. In the former, a single photodiode is used at the receiver to directly detect the signal and convert it to the electrical domain. This method is used for line rate signals of up to 40 Gbps and is more difficult to implement for higher speeds. Regarding coherent detection, it uses a local oscillator whose continuous wave (CW) signal is mixed with the incoming one. The receiver can retrieve signal amplitude and phase information to compensate the physical impairments by means of DSP algorithms. Indeed, coherent detection methods play important roles in new transmission systems and is a key enabler element for the reception of dual polarization schemes. This detection method basically allows the receiver to retrieve the full optical field information from the received signal, which is in clear contrast to direct detection methods where only the signal power is detected (e.g. 10 Gbps with OOK as MF).

Looking at current optical transport networks, several generations of TSPs can be found, LRs of 10 Gbps (OOK), 40 Gbps (Differential QPSK (DQPSK)) and 100 Gbps with dual polarization-QPSK (DP-QPSK) being the most widely deployed. The deployment of these high-speed systems may impose different transmission limitations compared to the traditional 10 Gbps OOK, which has a stronger tolerance in terms of OSNR and thus facilitates the transmission over longer distances.

2.2.2.2. Future directions for transponders

Increasing the network capacity has been one of the main goals of the research related to WDM for a long time. Deploying TSPs with higher capacity (often based on more complex MFs) seems to be the most straightforward way to increase network capacity.

Future generations of DWDM systems beyond 100 Gbps will most probably make use of some of the existing blocks for 100 Gbps including some improvements to make feasible the transmission with higher transmission rates. The basic elements in which the new TSPs will rely on are:

- **High-order modulation schemes** for the transmission of a higher number of bps/Hz.
- **DSP-assisted coherent** detection with advanced algorithms for impairments compensation. Future TSPs may also introduce DSP modules at the transmitter side.

- **Advanced FEC mechanisms** (i.e. FEC consists of sending redundant bits along with the data ones so that the receiver can correct most of the errors) to deliver a lower bit error ratio (BER).

In fact, moving to MFs with higher modulation orders requires higher OSNR values at the receiver, and may limit the transmission distance in potential deployment scenarios. As mentioned earlier, an increase on transmission rate above a certain value (e.g. 400 Gbps) would imply the use of multiple FSs (for the common ITU-T 50 GHz grid) by multicarrier modulation techniques or by single carrier with a wider bandwidth. Actually, for higher bit rate signals, multicarrier structures or “super-channels” will probably be needed. Despite the fact that multicarrier TSPs will be based on the existing blocks of a 100 Gbps TSP, they will bring new challenges. Indeed, all fiber impairments get more relevance when the symbol rate increases. Thus, the algorithms will play an important role in the development of these devices to compensate for the signal impairments by more complex algorithms at the receiver. Furthermore, architecture for future TSPs may also consider the presence of DSP modules at the transmitter side as well.

The need for higher bit rates motivated the introduction of “super-channels” and the concept of flexible-grid or EON, where a variable set of fine spectrum slots (e.g. 12.5 GHz) can be assigned to an optical channel according to the actual traffic demand values. As mentioned in Section 2.1.3.2, moving to a flexible-grid frequency plan is one of the research directions for future networks. Current WDM TSPs can benefit from the concept of flexible-grid by reducing the reserved channel spacing. For instance, for a 100 Gbps with DP-QPSK, the allocated bandwidth could be reduced to three FSs of 12.5 GHz (37.5 GHz) resulting in improved spectral efficiency with respect to the traditional ITU-T grid of 50 GHz. However, for the full realization of the EON paradigm, new modulation techniques might be required in addition to the change in the spectrum allocation and ROADMs components. In fact, new TSPs are not only supposed to transmit signals in a wider range spectrum than conventional WDM, but also finely adjust the LR to different traffic demands.

The TSP used in EON is often called BVT and it is able to operate at different rates and employ different MFs depending on the requirements (by software reconfiguration of MF and bandwidth), which is in contrast to traditional fixed-rate TSPs. BVTs can generate a multicarrier structure or “super-channel” that could be carried and treated as a single entity in the network. In order to meet the requirements of a BVT (e.g. elastic bandwidth and selective MF), the OFDM modulation technique, which is a well-known technique in wireless systems such as LTE, can be adopted. Figure 2.10 depicts the spectrum savings that can be achieved when OFDM subcarriers are overlapped in a flexible-grid configuration with respect to the fixed-grid allocation. The subcarrier frequencies are selected in a way that they are orthogonal to each other, meaning that cross-talk between the sub-channels at the sampling points is practically removed. The concept of optical OFDM in optical transport networks was firstly introduced and experimentally demonstrated in references [16],[22-23].

Indeed, the introduction of optical OFDM opens new horizons for network planning and operation. OFDM permits a fine allocation of the spectral resources to meet different service requirements with super- and sub wavelength granularities. The basic idea of OFDM is based on allocating the data into low-rate subcarriers which permits a fine granularity at the subcarrier level. Furthermore, OFDM uses orthogonal signals in the frequency domain, so that individual subcarriers overlap and the channel spectral occupation can be reduced. There are some

elements in a BVT which are different from those in conventional coherent WDM TSPs. The main difference lies in the presence of a DSP module and two digital to analog converters (DACs) at the transmitter, used to adjust the MF and bit rate for each subcarrier. Additional details about the architecture of BVTs can be found in references [24-25].

The adaptive line rate possibility is achieved by means of the bandwidth elasticity (i.e. allocation of a variable number of low-rate subcarriers) and the MF changes (i.e. DSP techniques and coherent detection allow the TSP to transmit and detect subcarriers with different MFs).

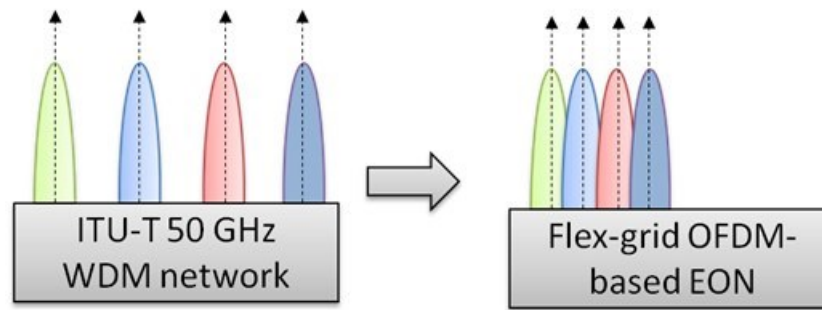

Figure 2.10. Spectrum savings when using OFDM-based EON with respect to ITU-T 50 GHz WDM network.

Increasing the overall network capacity is definitely one of the main objectives pursued in the development of new TSPs, but there are other requirements such as cost and PC figures that must be taken into account. For instance, the introduction of power saving techniques, such as powering-off some of the components/elements of the TSP at low traffic periods would be beneficial to increase overall energy efficiency. This will enable the application of sleep-mode if different working states are defined.

On the other hand, cost is obviously one of the main drivers for the deployment of a new technology. Hence, techniques allowing for lowering the cost per transmitted bit considering both CapEx and OpEx would definitely have better chances to be adopted by operators. Regarding the EON concept, BVTs will probably be more expensive than fixed-rate TSPs. Thus, if they have to transmit at low-rates, part of their capacity would remain unused becoming even less cost-efficient. To solve this issue, the concept of slice-ability was introduced in [24] which permits to slice the BVT into a set of virtual lower-capacity TSPs that can be used to transmit data to different destinations. Thus, sharing the TSP for different flows may greatly improve the cost-efficiency of EON. Another potential benefit of BVTs comes from the possible deployment of a single type of TSP in the network which can be upgraded to provide a wide range of bit rates.

2.2.3. Optical switching

2.2.3.1. Principles

A switching element must be capable of getting an optical signal carried on any wavelength at an input port and switching it to a particular output port. The switching process can be performed electronically, optically or a combination of both. Optical switching is usually preferred as it allows for directing the light between different ports without OEO conversions, thus reducing PC.

As previously stated, the optical switching elements are known as ROADMs or OXCs. The term ROADM is more commonly used when the nodal degree (i.e. number of edges (fibers) connected to a node) is one or two, whereas OXC refers to nodes with a larger degree (i.e. connected to more than one node).

The principles of optical switching can be realized by different architectures and type of components, but the analysis of the particular switch architectures is out of the scope of this work. Further information on the architecture and components for the realization of optical switches can be found in [26]. In fact, very diverse optical switches can be created and adapted to suit special requirements in terms of scalability (i.e. number of ports and blocking), switching speed, insertion losses, extinction ratio, reliability, etc.

Some of the main parameters to consider for future networks are the insertion and splitting losses that the optical signal may suffer when traversing the switches. The switching elements traversed by the optical signal may also insert losses, which are commonly compensated by the pre-amplifier and booster at the input and output of the node, respectively. The installation of OAs can also be considered to compensate for the losses introduced at the add/drop stages. Other important features are the extinction ratio (i.e. ratio of the output powers in on-state and off-state) and the reliability for protection purposes (i.e. in case of failure, some ports that are in off-state or sleep-mode must be activated in a very short time).

2.2.3.2. Current optical switches and challenges

Current optical transport networks comprise a set of OXCs that perform the signal switching at the optical level. This functionality brings an enormous scalability increase compared to electronic switching mechanisms (e.g. legacy SDH) as well as relevant reductions in terms of CapEx and PC.

As mentioned in Section 2.1.1., current WDM networks operate according to the frequency spacing and center frequencies specified in the ITU-T in the Rec. G. 694.1 [11]. Accordingly, OXCs must be compliant with the ITU-T frequency plan and be capable of adding/dropping or switching channels of 50 GHz/100 GHz.

In a context where traffic is rapidly growing, telecom operators are facing high pressure to update their networks to cope with the new requirements. Capacity upgrades commonly entail the deployment of new equipment and equipment reconfigurations, which involve many manual interventions. Therefore, reconfigurability features are essential for optical nodes to address potential changes that may occur and simplify the intervention and management of the network. In particular, some of the desirable features for optical switches to enhance the flexibility and facilitate the network planning processes are:

- A larger switching degree, resulting in a denser interconnectivity and larger capacity in terms of client signals.
- A simplified node architecture that requires fewer elements to ease management and reduce both cost and PC. The installation of coherent TSPs helps pursuing this objective as frequency filters can be avoided due to the filtering effect of the detection process.
- The colorless, directionless and contentionless (CDC) features, that enable the use of tunable TSPs (colorless), the signal switching from any input to any output port (directionless) and the possible reuse of the same wavelength (not sharing a physical path) by different TSPs connected in different slots of the node (contentionless).

2.2.3.3. Future optical switches

The introduction of the bandwidth variable elements (i.e. BVT and BV-OXC) in EON will change the way networks are currently operated. Thus, in order to provision a traffic demand between two nodes in EON, the BVT can create an appropriately-sized optical signal composed of different subcarriers with the most appropriate MF (e.g. the MF could be selected according to PC, spectral

efficiency or any other parameters). Every intermediate BV-OXC in the route then sets the appropriately-sized spectrum cross-connection to create the end-to-end LP. In this manner, it is possible to allocate just the required spectrum size for the optical path with the consequent reduction in spectral occupancy. A “super-channel” structure spanning over a wide frequency band would be switched along the optical network as a single entity.

In this scenario, the OXC capabilities have to be extended to be compatible with the use of a flexible frequency grid (whereby different spectral widths can be assigned to the optical signals). Thus, a BV-OXC requires the implementation of the gridless feature to allow signals with variable bandwidths to be switched. This implies a move from fixed and single channel spacing to variable bandwidth channels (from narrow bandwidth such as 12.5 GHz or 25 GHz to super-channels wider than 50 GHz). This novel functionality in the OXCs allows for a more flexible use of the optical spectrum as spectrum slots can be defined more arbitrarily than in conventional optical networks.

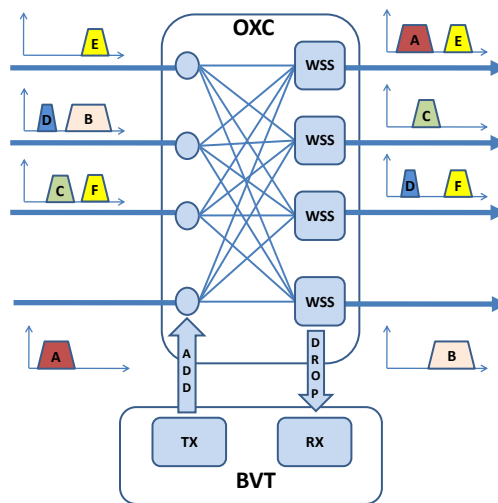

Figure 2.11. Potential architecture of a BV-OXC.

A possible architecture for the so-called BV-OXC used in EON is depicted in Figure 2.11, i.e. composed of optical splitters at the inputs and flexible-grid wavelength selective switches (WSSs) at the outputs. A flexible-grid WSS provides the required flexibility in the selection of the channel bandwidth and center channel frequency [27]. In fact, the OXC depicted in Figure 2.11 can meet the reconfigurability requirements envisioned for future optical switches. That is, it is colorless (any color can be received in any input and switched to any output), contentionless (the same color could be received over two inputs, such as the yellow signals coming from nodes E and F), directionless (any of the incoming signals can be switched to any output), and gridless (the device is able to operate with signals of different bandwidth).

2.2.4. Optical amplification

2.2.4.1. Principles

OAs are basic enabler elements for long-haul optical communications to improve the power levels of optical signals without converting them into the electrical domain first (as in REGs). This allows for extending the distance that an optical signal can travel over the fiber. Moreover, OAs can amplify all the signals contained in the C-band spectrum, while REGs are dedicated per channel. OAs can serve different functionalities:

- **In-line amplifier:** Used in the links of passive transmission fiber to compensate for transmission losses. In deployment scenarios, they are placed in the links for fiber spans of 80 km approximately. The gain must be adjusted in such a way that the optical power does not significantly drop, which would greatly deteriorate the OSNR, while, at the same time, transmitting excessive optical power must be avoided in order not to increase the non-linear penalties.
- **Add/Drop stages amplifiers:** Used at the add/drop stages to compensate the insertion losses of the splitters/combiners which are placed right before and after the TSPs.
- **Booster:** Used after the output of the node to boost the optical power of a signal before being transmitted over a fiber span.
- **Pre-amplifier:** Used before the input of the receiver to improve the signal power of the incoming signals and compensate for the losses of the span right before the node

Even though OAs improve the signal power levels and allow for overcoming the different signal losses of the transmission, they also introduce noise. Signal in OAs degrades mainly due to amplified spontaneous emission (ASE). In addition to the gain (G), the noise figure (NF) is a very relevant parameter regarding amplifier performance. NF is a measure which indicates how much noise the amplifier adds to the signal, and it strongly depends on the gain provided by the OA. The noise contribution is taken into account in the OSNR computation of the LP.

There are two main well-known types of amplification for optical transport networks, which will be discussed in the following subsections: EDFA and distributed Raman amplification. EDFA is the most widely deployed OA, while Raman amplification can be considered to extend the transmission of high-speed optical systems by taking advantage of its lower effective NF .

2.2.4.2. Erbium doped fiber amplifier

The erbium-doped fiber amplifier (EDFA) has been one of the key enablers for the widely deployment of DWDM systems. These OAs have been commercially available since the early 1990's. EDFAs are based on the stimulated emission effect. They are basically composed of an optical fiber with a length of a few meters doped with the rare-earth element erbium, the so-called erbium-doped optical fiber (EDF). EDFAs are required to be pumped at 980 nm or 1480 nm, as shown in Figure 2.12a. The main advantage of the employment of EDFA is the possibility of amplifying all the channels in the C-band (1530 – 1560 nm) spectrum. The NF of commercially available EDFAs can be in the range between 4 and 6 dB.

2.2.4.3. Raman distributed amplification

The operation of a Raman amplifier is based on the principle of stimulated Raman scattering (SRS), which is a non-linear effect that occurs on the fiber. A Raman amplifier is composed of a high-power pump laser and a fiber coupler and the transmission fiber section as a gain medium. The distributed Raman amplification (DRA) laser can be connected to the fiber in either a counter pump (backward pump) or a co-pump (forward pump) configuration as shown in Figure 2.12b. Counter pump assumes that the pump power is introduced at the end of each span and propagates counter to the signal. Since gain occurs along the transmission fiber, DRA prevents the signal from being attenuated to very low power levels, thus improving the OSNR of the transmitted signal. This also permits launching the signal with less power, so that working with very high signal power at the beginning of the span can be avoided to prevent problems with non-linear effects. In the co-pump configuration, on the other hand, the Raman pump power is

introduced at the span input and propagates with the signal. This approach causes less noise, but may induce decreases on the performance due to the non-linear effects caused by the high power levels. Therefore, the co-pump configuration is generally less common than the counter pump configuration, which is generally preferred.

When comparing EDFA and distributed Raman amplifiers, one of the main differences lies in the fact that EDFAs require the deployment of special EDFs, while Raman amplification can occur in any fiber (it is an intrinsic effect of all fibers), and in particular the transmission fiber itself. This presents obvious advantages as it only requires continuous-wave 100-mW pump lasers and not special fibers.

As mentioned, the main advantage of Raman amplification is its lower effective NF compared to EDFA which allows for much lower OSNR degradation. Typically, the NF of a Raman amplifier is in the range between -2 and 0 dB, which could be about 6 dB better than the NF of an EDFA. Another advantage is the possibility to amplify more spectrum bands (EDFAs just operate in the C band). Usually a Raman amplifier is more expensive and presents lower gain than EDFAs. The gain of a Raman amplifier is dependent on the signal separation from the laser pump wavelength. Counter pump DRA are often combined with EDFA pre-amps to extend span distances. This hybrid configuration is commonly referred to as hybrid Raman-EDFA (HRE).

Despite the potential advantages of Raman amplification, there are some challenges which might impact its actual application in real deployment scenarios. These disadvantages are related to the need of working with very high power levels (which may raise some safety issues and also raise penalties due to non-linear effects,) as well as its significantly higher cost over EDFA.

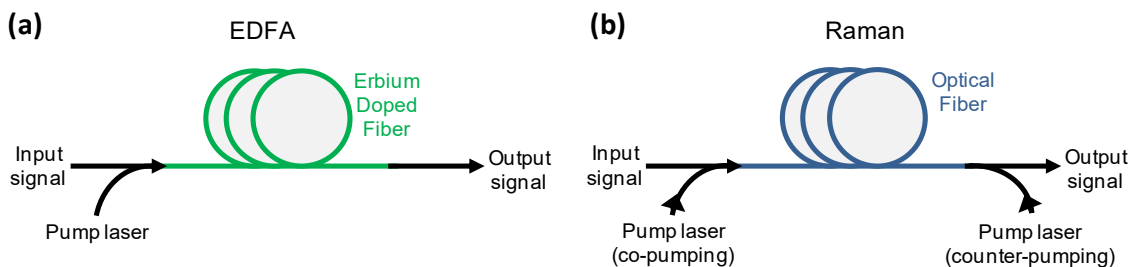

Figure 2.12. Representation of optical amplification with: (a) EDFA; and (b) Raman.

2.3. Network planning and design

2.3.1. Concepts

Before explaining the main parameters and principles of network planning in optical transport networks, it is worth defining some important concepts for the service provisioning in telecommunication networks as explained in [28]:

- **Traffic engineering:** This process aims at putting the traffic where the bandwidth is available in an already operating network. Basically, it refers to the routing process where decisions are made online within a time span of several milliseconds.
- **Network engineering:** This process refers to putting the bandwidth where the traffic is. In other words, it aims at avoiding traffic congestion by deploying more resources in some particular parts of the network. The time scale could be from weeks up to several months.
- **Network planning:** This process refers to the process of putting the bandwidth where the traffic is forecasted to be. It is an offline process that needs to anticipate traffic growth to

add bandwidth ahead of time. Once the network is planned, it is supposed to support the traffic requirements for several years without relevant capacity upgrades.

The network planning is in fact, one of the most important processes, as it will target the design of the network from scratch. The most common formulation assumes that when given a set of traffic demands among various pairs of nodes, the network has to be designed in order to be able to serve all the demands and optimize certain design parameter (e.g. cost, PC, fiber utilization, etc.). In other words, determining how much capacity to put on each link of the network, as well as routing the traffic over the network links.

2.3.2. Traffic

Network planning is essentially influenced by the available information regarding the data traffic pattern. Traffic is mainly generated by users when they transfer and access information, and is therefore dependent on their behavior.

Actually, traffic is a parameter that varies not only in the long-term (exponential yearly traffic growth), but also fluctuates in the short-term, e.g. day versus night or working days versus weekends. Thus, in order to cope with the uncertainty of traffic evolution, networks are commonly over-provisioned (i.e. designed with a quantity of resources larger than the required ones) to support not only the unpredicted traffic peaks, but also the forecasted growth for several years.

Another important consideration for planning optical transport networks is the fact that no single user is able to generate traffic to occupy the capacity of a full wavelength (i.e. several Gbps), so that the optical resources are frequently shared for the transmission of smaller traffic flows originating from different users. This process is called traffic grooming and consists of grouping several small traffic flows into larger units to be treated as single entities in the network. The strategy adopted by the operator to groom these traffic flows also influences the utilization of resources in the optical layer (e.g. whether grooming at the intermediate nodes is performed).

2.3.3. Physical constraints

The transmission over long distances with particular communication systems might be limited due to the accumulation of physical impairments. The optical (or transparent) reach is defined as the distance that an optical signal can travel in the network before it degrades to a level that needs to be regenerated. In fact, the transparent reach is one of the key features to consider in a TSP, as it determines its applicability to serve a traffic demand in the core network.

The transparent reach is reduced when increasing the channel bit rate, i.e. the higher the bit rate, the shorter the transmission reach will be. For instance, the transmission reach of 10 Gbps with non-return-to-zero on-off keying (NRZ-OOK) is estimated to be approximately 3000 km, while for 100 Gbps with DP-QPSK it might be reduced to 1000-1500 km (note that the transmission reach depends on the particular network conditions such as the quality of the transmission link, the number of filtering stages traversed by the LP, forward error correction (FEC) techniques, span lengths, etc.).

If transparent reach is not feasible, regeneration might be necessary. Regeneration is commonly realized by OEO conversions with regenerator cards or back-to-back TSPs. This entails the deployment of additional network elements which will affect both CapEx and OpEx (e.g. energy consumption cost). Networks can be classified by the presence of regeneration as depicted in Figure 2.13: (a) *Opaque* (regeneration performed at every node); (b) *Transparent* (no

intermediate regeneration is carried out); and (c) *Translucent* (selective regeneration can be carried out at certain nodes). Moreover, it is worth mentioning that in transparent networks the same wavelength (color) must be used from source to destination, whereas regeneration will allow for using different wavelengths or colors in different segments of the end-to-end LP.

In order to determine the transparent reach feasibility of a particular service in a network path, the physical impairments must be taken into account when planning the network (considering the particular link conditions, traversed nodes, OAs, TSPs, etc.). There are different precision levels for modeling physical impairments:

- **Basic models:** Approximations such as maximum transmission distance or the number of hops could be enough to study certain hypotheses related to cost, energy efficiency, spectral efficiency or other parameters.
- **Advanced models:** Physical layer modeling simulation tools are more appropriate for real network deployments. These tools may consider power budget computation, OSNR values or quality of transmission (QoT) factor while taking into account linear and non-linear impairments.

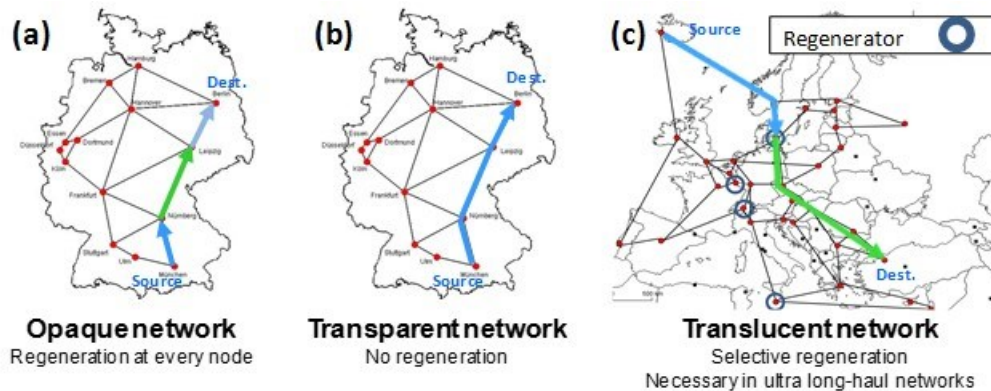

Figure 2.13. Representation of LP allocation in: (a) Opaque; (b) Transparent; and (c) Translucent networks.

2.3.4. Current optical transport networks

Current optical transport networks can also be referred to as wavelength switched optical networks (WSON). Optical end-to-end connections or LPs are established in the optical layer by using the wavelengths of the optical fibers in a circuit-switched fashion. These wavelengths are switched by the OXCs on a per-wavelength-basis.

Different layers can be distinguished in an optical network:

- **Data or forwarding plane:** Enables the data transmission between optical nodes.
- **Control plane:** Enables topology discovery, routing decisions, signaling.
- **Management plane:** Enables monitoring of devices and performance, fault tolerance, administration, and maintenance.

Despite the fact that the data and control planes in current networks are commonly coupled, in the future, a dynamic control plane might be in charge of the service provisioning and maintenance and built as a separate network with network controller(s), which can be centralized or distributed (typically a network controller for each node in the data plane).

2.3.4.1. WDM single line rate networks

In current optical transport networks, the resources are commonly assigned at the wavelength granularity, so that the process for selecting the appropriate wavelengths will be key in the process. In fact, the network planning problem in WDM networks is commonly known as routing and wavelength assignment (RWA). In other words, given a set of traffic demands between a set of nodes (commonly in a traffic matrix), and a given constraint on the number of wavelengths and fibers, the problem consists of finding the routes over which the LPs have to be established and assigning the corresponding wavelengths with the goal of transporting the maximum traffic in the network. Several constraints must be considered in the RWA formulations for WDM transparent networks as depicted in Figure 2.14:

- **Wavelength continuity constraint:** The same wavelength must be used in the different links in the path (in transparent networks).
- **Distinct wavelength constraint:** All LPs conveyed over the same link (fiber) must be assigned different wavelengths.
- **Physical layer constraints:** The chosen transmission system (e.g. modulation format) must provide enough optical reach for the selected path, as explained in Section 2.3.3.
- **Wavelength availability constraint:** A wavelength can be assigned only if the maximum number of wavelengths per fiber has not yet been reached (e.g. 80 in the 4 THz of the C-band with the ITU-T grid of 50 GHz).

Moreover, additional constraints such as the maximum load of the links (to avoid traffic congestion), maximum cost or PC could be considered. If the previous constraints cannot be fulfilled for a particular traffic demand in any possible end-to-end path, the demand is assumed to be blocked.

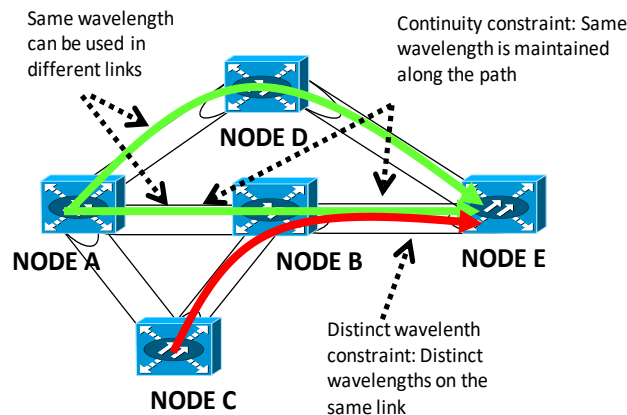

Figure 2.14. Constraints for routing and resource allocation procedures in optical transport networks.

The RWA problem is known to be NP-complete, meaning that it has significant complexity and no exact solution can be provided in a short period of time. In an integer linear programming (ILP) formulation, the objective and constraints can be written with linear functions to solve the routing and resource allocation problems simultaneously. It can be solved by an ILP solver, but the computation time grows exponentially with the size of the network and therefore the ILP problem solving is only feasible for small networks. Therefore, heuristics are more appropriate for large networks. Despite the fact that they do not provide optimal solution, the solution could be good

enough and obtained in an acceptable time frame. Generally, heuristics aim at solving the problem in a decoupled approach (i.e. first routing and then wavelength assignment).

Routing is commonly done by calculating a set of shortest paths (k shortest paths (KSP)) based on Dijkstra's algorithm [29]. KSP may use different metrics to calculate these paths such as the physical distance, cost, PC, less loaded links, etc. As for wavelength assignment (WA), it can follow different strategies according to the manner in which the wavelengths are assigned. For instance, first fit (assigns the first wavelengths identifiers first), last fit (assigns the last wavelengths in the spectrum first) or random fit (assigns the wavelengths randomly).

2.3.4.2. WDM mixed line rate networks

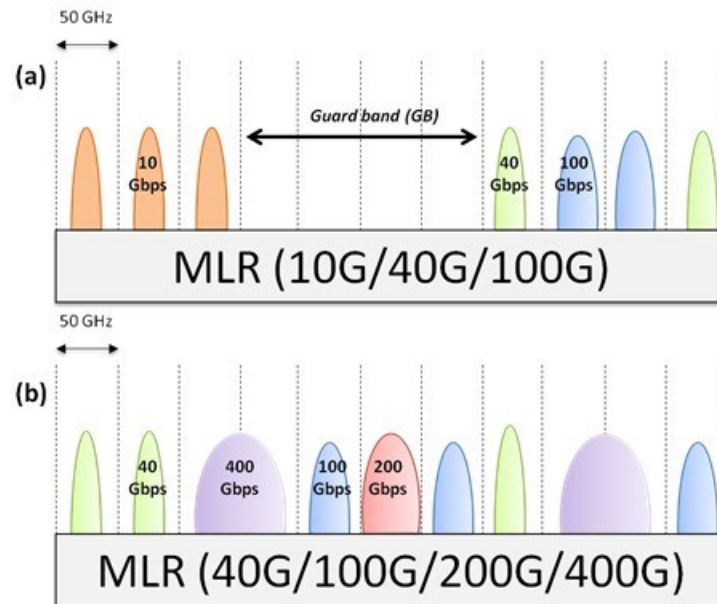

Figure 2.15. Spectrum for WDM MLR networks: (a) MLR of 10/40/100 Gbps; and (b) MLR of 40/100/200/400 Gbps.

As discussed in Section 2.1.3.1, optical transport networks are becoming more heterogeneous in terms of throughput as some node-pairs may exchange considerably higher amounts of traffic than others. This is due to the fact that the traffic demands are not growing at the same pace in all parts of the network. As a result, operators are forced to make successive capacity upgrades for some particular connections. While upgrading, operators might choose higher-speed TSPs if they are commercially available and compatible with the legacy equipment.

The presence of more than a possible line rate to be selected in a MLR networks entails some changes for network planning in the RWA algorithms with respect to SLR:

- **Selection of line rates:** Criteria for selecting the most convenient combination of TSPs (e.g. minimum number of wavelengths, minimum cost, minimum PC)
- **Different optical reaches:** The different tolerance to physical impairments of the transmission with different modulation formats and rates must be taken into account, i.e. the higher the bit rate, the lower the transmission reach. This implies that not all transmission rates are feasible for a given end-to-end path.
- **Cross-talk:** A guard band (GB) may be inserted to separate the 10Gbps generation (using OOK) from the new ones (based on PSK modulation format) to avoid crosstalk. For instance,

in [30], the spectrum is divided into two different bands by the insertion of a GB of 200 GHz to separate the 10 Gbps channels from the rest, as depicted in Figure 2.15a.

- **Different channel spacings:** Future systems such as 400 Gbps may require the assignment of two contiguous ITU-T grid slots (i.e. 100 GHz) as seen in Figure 2.15b.

2.3.5. Future optical transport networks: Elastic optical networks



Figure 2.16. Resource allocation in an OFDM-based EON.

As mentioned earlier, conventional networks operate in a static manner (i.e. resources are assigned to serve a traffic demand for a long period of time). In the future, the optical transport network is envisioned to move from static to dynamic operation to achieve a better utilization of the network resources. In a dynamic scenario, the clients are assumed to request the service on a demand basis. Offering BoD services by allocating the resources according to the variable traffic requirements of the clients is indeed one of the most promising functionalities expected for an SDN. Moving to dynamic networks will require the network to be adaptive to different conditions and fast enough to adapt to changes.

As explained in 2.1.3.2, EON architectures are envisioned to replace conventional fixed-grid WDM architectures. EONs entail significant changes in network planning and the ways that optical services are provisioned.

- **Network planning algorithms:** Besides the WDM constraints mentioned in Section 2.3.3, which also apply to EON (i.e. distinct wavelength, wavelength continuity, physical layer and wavelength availability constraints), the EON paradigm brings additional changes concerning routing and resource allocation tasks such as:
 - Modulation format selection: The availability of different MFs imposes the definition of new criteria to select the most appropriate one in certain conditions. These criteria may include aspects such as the traffic demand value, the transparent transmission feasibility (each MF may provide different optical reach), and the defined optimization objective (e.g. minimum PC, cost, etc.)
 - Finer channel spacing: The spectrum is divided into FSs of very fine granularity (e.g. 12.5 GHz) so that the total number of resources to assign is larger than that of conventional WDM networks (i.e. 320 FSs).
 - Contiguous spectrum constraint: The spectral resources (FSs) for a particular traffic demand have to be assigned in a contiguous manner.
 - Channel separation: A GB needs to be inserted to separate adjacent channels, so that they can be treated as single entities and switched independently in the network.

An example of spectrum allocation with EON is shown in Figure 2.16, where four channels with different bandwidth and MF are transmitted, resulting in four particular line rates. These channels are separated by GBs.

Due to the significant changes with conventional RWA algorithms, the network planning problem for EON is referred to as routing, modulation level, and spectrum allocation (RMLSA). Moreover, when assuming dynamic operation, the spectral resources may become fragmented in flexible-grid networks (e.g. variable spectral gaps between allocated signals, where new traffic demands may not be accommodated due to the lack of resources). To overcome this issue, some “hitless” (or with negligible impact) defragmentation technique could be convenient such as the one proposed in [31] to reduce the blocking probability, and thus increasing the overall network capacity.

- **Physical impairments:** The migration from conventional WDM networks to EON implies a change from a few and well characterized MFs to a wide range of formats. Accordingly, the evaluation of the physical impairments becomes more demanding to determine which MFs can be feasible for a given distance and given combination of neighboring channels (adapting the MF according to the path length). For instance, 16-QAM (or even higher order MFs) can be used for short distances, whereas more robust MFs such as BPSK or QPSK could be used for longer distances, thus reducing the number of necessary regenerations. In order to determine which MFs might be feasible, more advanced physical layer modeling tools are necessary. The availability of these advanced tools will be even more essential when the dynamic traffic variations are considered.
- **Control mechanisms:** In order to fully exploit the potential advantages of EON, more advanced control mechanisms are required (especially when considering dynamic network operation). Thus, control plane extensions are required for generalized multi-protocol label switching (GMPLS) signaling and routing protocols, as well as path computation element (PCE) to take into account the particular spectrum allocation constraints of EON.

2.3.6. Resilience schemes

Resilience is a key parameter to account for when planning optical networks. This is becoming even more critical as the traffic carried in a fiber increases. Common survivability mechanisms can be divided into two broad groups: restoration and protection. The former is a dynamic recovery performed “on-the-fly” after a failure has occurred, whereas the latter is a pre-planned failure recovery. Therefore, protection is commonly preferred by the operators as it entails a much faster and more secure solution than restoration, where there is no guarantee on whether the service could be restored. The numerous protection schemes can be classified into two broad groups:

- **Dedicated protection (DP):** Spectral resources are reserved along the working and protection or protection (link-disjoint) paths, which are dedicated to a particular traffic demand. The different DP schemes can be distinguished according to the strategy adopted for the transmission on the protection (also known as backup) path. In particular, the most common DP schemes are DP 1+1 and DP 1:1. In the former, the transmission is active on both working path (WP) and protection path (PP), thus requiring the deployment of duplicated TSPs (Figure 2.17a). On the other hand, DP 1:1 assumes that the transmission is carried out either on the WP or on the PP at a given time. As for DP 1:1, it can use TSPs only for the WPs (no TSP redundancy), or can duplicate the TSP for the working and PPs similarly to DP 1+1, as shown in Figure 2.17b.

For network planning, DP implies that that a WP and a PP (which must be completely link-disjoint with respect to the working one) must be computed. The longer distance of the PP

may entail additional constraints for the transmission, as the transmission might be feasible for a particular MF in the WP, but not in the PP.

- **Shared protection (SP):** In SP, the spectral resources are not dedicated to a specific route, but can be used for transmission on the PP in case of failure. It is important to point out the difference between SP and restoration. In SP, the PPs are pre-computed (thus guaranteeing recovery); whereas with restoration, these are computed after a failure event with a consequent longer RT. Moreover, the recovery by restoration might be unsuccessful if sufficient spectral resources are not available for establishing a LP on the PP (recovery is done online without prior knowledge of the network state). From a network planning perspective, a WP and a set of pre-computed PPs are provided (the selection of one or another will be done according to the link which has failed). An example of operation of the SP scheme is depicted in Figure 2.17 before (Figure 2.17c) and after a failure (Figure 2.17d), showing the corresponding recovery with a stored PP.

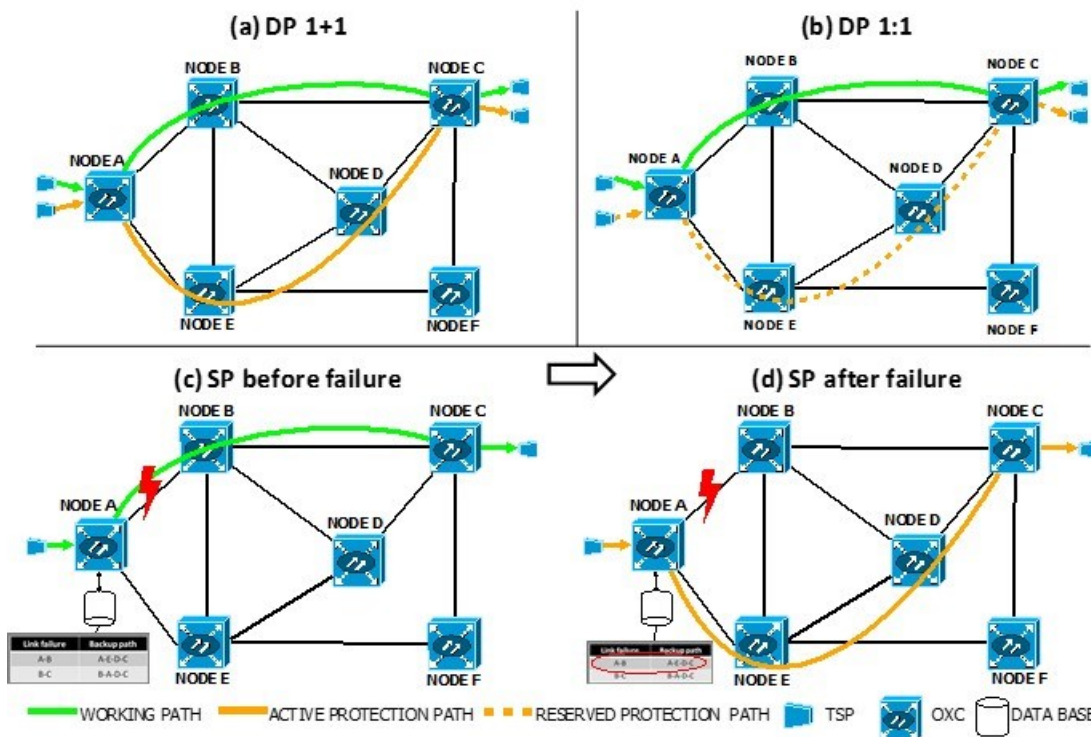

Figure 2.17. Example of operation of (a) DP 1+1; (b) DP 1:1; (c) SP before failure occurs; and (d) SP after failure.

It is worth mentioning that the above protection schemes can be applied at different levels: path, link or segment. Many other protection schemes have been proposed in literature (e.g. the p-cycles schemes in [32]) to achieve a more efficient utilization of the spectral resources, while maintaining high service availability. Nevertheless, DP 1+1 is still the option of choice in real deployment scenarios due to its simplicity and the high reliability that it offers. It is also worth mentioning that these survivability techniques are commonly resilient against one or several simultaneous failures (commonly a single link failure is considered), but more advanced techniques, which may take into account multiple failures in catastrophic scenarios are also under research (e.g. survivability against massive failures such as earthquakes [33]).

In the selection of a protection scheme, the protection-switching time or recovery time (RT) is one of the key parameters, i.e. the time interval between a failure and recovery of the connection. RT is especially important for critical and non-delay tolerant services such as voice, trading or financial transactions. Historically, operators have built their networks to provide RT values shorter than 50 ms. The RT figures depend on the equipment features (e.g. switching time) and the manner in which the service is recovered after a failure (i.e. the protection scheme). More specifically, RT can be calculated by considering the time to detect the failure (FD), the propagation delay (PD), the message-processing time at the node (MP), the time to configure and setup a cross connection in the optical switch (TO) [31]. Some values are dependent on the equipment features (i.e. MP and TO), whereas PD depends on the path length and can be calculated as a function of the number of spans in a particular path, assuming spans with similar length (n : number of spans on the WP, m : number of spans on the PP). Table 2.2 contains the formulae to calculate the approximate RT for optical services with the three most common protection schemes based on the previous parameters, and assuming the same PD and MP in both WP and PP. Despite the fact that the RT certainly depends on the particular network and equipment (e.g. distance and number of nodes in the WP and PP), the protection schemes can be sorted as follows in terms of RT: DP 1+1 < DP 1:1 < SP. It is worth mentioning that for networks highly spectrally occupied, RT may increase if longer PPs have to be selected for provisioning the service (i.e. due to the larger m and n values).

Table 2.2. RT with protection schemes: DP 1+1; DP 1:1; and SP.

<i>Protection scheme</i>	<i>RT</i>
<i>DP 1+1</i>	<i>FD</i>
<i>DP 1:1</i>	$FD+n \cdot PD+(n+1) \cdot MP+2 \cdot m \cdot PD+2 \cdot (m+1) \cdot MP$
<i>SP</i>	$FD+n \cdot PD+(n+1) \cdot MP+2 \cdot m \cdot PD+2 \cdot (m+1) \cdot MP+(m+1) \cdot TO$

CHAPTER 3. OVERVIEW OF ENERGY CONSUMPTION IN OPTICAL TRANSPORT NETWORKS

3.1. Energy efficiency

3.1.1. Energy consumption in the ICT sector

As mentioned in the introductory chapter (Chapter 1), ICT services are spreading to more aspects of our daily lives (both professional and private) and reaching more population sectors. We are moving towards an all-connected world where everyone will not only be connected to the Internet, but we will also be able to control and monitor almost everything via the Internet, from cars to refrigerators or washing machines (the so-called Internet of Things).

For the operation of the ICT, energy will be consumed not only in the fabrication of the devices and by the devices themselves, but also in other activities related to the operation of ICT companies (e.g. buildings, maintenance, air conditioning, etc.). In a context where energy is becoming a scarce and increasingly expensive resource, improving the overall energy efficiency is becoming a key challenge for all institutions related to ICT.

3.1.1.1. Energy consumption values of ICT

The ICT sector involves numerous activities, services and organizations worldwide which makes its carbon footprint very difficult to estimate. Indeed, some consensus is necessary to establish a reliable methodology on PC and carbon footprint for the ICT sector. In this regard, the European Commission launched a program called ICT-footprint [34] to set a common methodology for this purpose. In addition to this initiative, some publications already attempted to estimate the ever-increasing ICT carbon footprint. For instance, Van Heddeghem et al. estimated the evolution of electricity consumption in the period 2007-2012 (providing a detailed explanation of the methodology) in [35]. The authors claimed that the worldwide electricity of the ICT sector grew from 3.9 percent in 2007 to 4.6 percent in 2012 (these percentages did not include the contribution from TV sets, phones and other user equipment). These values are expected to continue rising in the near future due to the traffic growth, reaching around 8 percent of the energy consumption by 2020 [34]. In addition, the authors also estimated the annual growth of electricity consumption will be around 10 percent.

Increased energy consumption has economical, technical and ecological implications. Electricity bills will rise for both users and Internet service providers (ISPs) making a significant impact on OpEx. Reducing PC is also essential from the technical point of view when considering the associated heat dissipation and the energy density limitations [36]. The increasing power density in the equipment may require the heat to be dissipated by means of cooling techniques which also consume relevant energy. Moreover, traditional non-renewable energy sources are commonly used (e.g. 85 percent of the electricity in the United States of America is generated by non-renewable energy sources [37]). The combustion of the primary sources to generate

electricity and its consequent transportation result in increased GHG emissions which is one of the major causes for global warming (i.e. increase of the Earth's temperature). Based on these three (economical, technical and environmental) aspects, there is a growing interest in reducing PC and keeping emissions as low as possible to protect our environment by, for instance, moving to renewable energy sources.

3.1.1.2. Energy consumption values of telecom networks

Breaking down the different contributions of energy consumption of the ICT sector is also a difficult task, especially due to the diverse contributions that must be considered in the calculation. In this regard, telecommunication networks certainly take a significant part of the total energy consumption of the ICT sector.

For example, in [38-39] the authors estimated that in 2009 Internet with access rates at around 1-5 Mbps (excluding computers, data centers and home networks) was responsible for 0.4 percent of the total electricity consumption in a broadband-enabled country. Baliga et al. also stated in reference [39] that the PC of the Internet was mainly dominated by the contributions of the access and the core networks routing functions. However, Van Heddeghem et al. estimated a higher value in [40]. They consider that telecommunication networks accounted for 1.7 percent of the worldwide electricity consumption in 2012, including operator networks, office networks and customer premises network access equipment.

The same authors also attempted to break down the PC of the ICT sector in data centers, personal computers, and networks in [35]. One of the main remarks is the fact that the electricity consumed by communication networks is increasing at a higher rate than the other contributions, and it was projected that it was going to overtake that of personal computers and data centers by 2012 (while in 2007 the three categories had similar consumptions).

Based on the estimations provided by different sources, it can be concluded that telecommunication networks might be currently responsible for approximately 1 to 2 percent of the total worldwide electricity consumption. Moreover, it is also envisioned that the contribution of networking to the worldwide electricity consumption will continue rising in the following years (i.e. an annual growth rate of 10 percent is predicted for PC according to [40]).

3.1.1.3. GHG emissions of the ICT sector

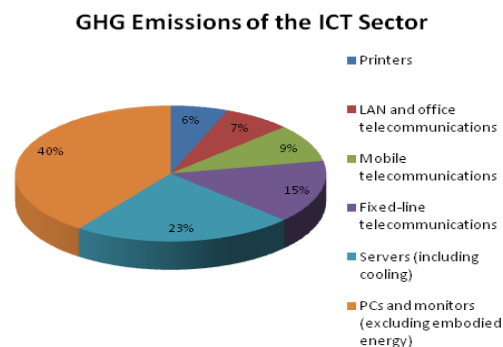

Figure 3.1. GHG emissions from ICT sector (based on [8]).

The relationship between energy consumption and GHG emissions is not always straightforward, as these mainly depend on the source of energy that is used. In some studies, such as [35], this relationship is assumed to be 500 gCO₂/kWh without distinguishing the energy source.

Renewable energy sources (i.e. those obtained from non-exhaustible resources) such as wind or solar energy may help decreasing the impact in terms of GHG emissions. Regarding this ecological matter, the ITU estimated that in 2008, the ICT sector (including telecommunications, computing and the Internet, but excluding broadcasting transmitters and receivers) was responsible for the production of 2-2.5 percent of the GHG, which is a value equivalent to that of the airline industry [8]. This contribution to the global emissions is expected to be even more significant in the future as the PC rises. For instance, the authors of [41] foresee that the carbon emissions from the ICT sector will be doubled in 2020. Within the ICT sector, the fixed and mobile communications are responsible for a 24 percent of the total GHG emissions [7] as shown in Figure 3.1 (i.e. 15 and 9 percent for fixed and mobile communications, respectively). The SMARTer2020 report also foresees a similar tendency, predicting that the GHG emissions from telecom networks would increase from 150 Mt per year in 2002 to 320 Mt in 2020 if appropriate measures are not adopted [42], with mobile and fixed broadband access parts being the most significant contributors to GHG emissions.

On the other hand, it is worth stating that ICT services might also be a part of the solution to reduce the carbon footprint of other sectors. For instance, a service like videoconference may help reducing the emissions associated with travelling. The ITU also considers the potential GHG reductions enabled by ICT services. In fact, the ITU differentiates the strategies to directly reduce GHG emissions from the reductions enabled by ICT services in other sectors (i.e. “Green ICT” and “Greening through ICT” [43]).

3.1.1.4. Initiatives to reduce the environmental impact of the ICT sector

The overall energy consumption will continue rising in the following years due to the ever-growing Internet traffic, becoming an even more significant issue. Therefore, an increasing number of public and private initiatives are emerging to enhance the energy efficiency and prevent energy consumption from scaling up. Some of these initiatives are:

- **GreenTouch consortium:** A consortium of leading ICT industry, academic and non-governmental research experts dedicated to fundamentally transforming communications and data networks, including the Internet, and significantly reducing the carbon footprint of ICT devices, platforms and networks. Their aim was to improve the energy efficiency of the network by a factor of 1000 with respect to 2010 levels in 2015 [44].
- **The Global e-Sustainable Initiative (GeSI):** International consortium of ICT companies and industry to promote the use of technology for sustainability. They released relevant reports such as Smart2020 [42] and Smarter2020 [45]. For example, the potential benefits of ICT to reduce GHG emissions are estimated in [45]: “*ICT-enabled solutions offer the potential to reduce GHG emissions by 16.5 percent, create 29.5 million jobs and yield USD 1.9 trillion in savings*”.
- **Publicly funded projects:** There have been several public funded projects aiming at improving the energy efficiency of telecommunication networks. For instance, in the European Union, the TREND (Towards Real Energy-efficient Network Design) [46] and the ECONET (low Energy CONsumption NETworks) [47] projects, among others, were initiated with that objective.
- **Internal projects run by operators:** Sustainability and corporate responsibility are important concepts for organizations and companies, as well as reducing OpEx. For instance, the Orange group is attempting to reduce the impact of its activities in terms of energy consumption and gas emissions by 15 and 20 percent in 2020 with respect to the

levels of 2006, respectively. Some of the considered measures include the reduction of energy consumption of the equipment and buildings, and the migration to renewable energy sources [48]. Another operator, Telecom Italia has also been dramatically affected by the increase on energy consumption, being reported as the second largest electricity consumer in Italy in 2010 with 2200 GWh (only behind the national railway operator) [6]. Especially significant is the contribution of the network infrastructure which accounts for around 70 percent of the total energy requirements. For this purpose, they launched a program for a sustainable future with reduced emissions by means of a more energy-efficient network operation [49]. Similar breakdowns can be extrapolated to incumbent operators in other countries. For instance, in the United Kingdom, British Telecom reported 2600 GWh in 2008, making it the largest single national electricity consumer [50].

- **Internal projects run by equipment vendors:** Achieving low PC is being set as one of the main requirements for the development of new products. Vendors such as Huawei [51] and Ericsson [52] are putting significant effort on reducing their carbon footprint. For instance, new products are commercialized showing decreased energy consumption figures (e.g. Infinera's photonic integrated circuits (PICs) of 400 Gbps consume 50 percent less than those of 100Gbps currently commercialized [53]). As mentioned before, from the technical point of view it is important to reduce PC. Accordingly, vendors are also actively involved in some initiatives like the GreenTouch [44], GeSi, and some European Union-funded projects to improve the overall energy efficiency of telecommunication networks.

3.1.2. Energy consumption in optical transport networks

The energy consumption of telecommunication networks was broken down in Section 3.1.1.2. As mentioned in Chapter 2, telecommunication networks are composed of different segments. Figure 2.1 presents an overview of how a global telecommunication network is structured and subdivided into different segments or domains. These segments are mostly defined by the distance from the end user.

The PC of every network segment is expected to increase at a higher or lower pace. Lange et al. study the PC evolution of each part of the network [54], showing that the overall energy consumption will significantly increase as traffic augments. Home networks consume significantly higher energy values than other parts of the network belonging to the operator. Regarding the power consumed in an operator network, the authors envision that inter and intra data center networks will soon become the main contributor to energy consumption, followed by the mobile and access parts. Furthermore, it is also predicted that the core network will suffer the higher increases in energy consumption with traffic growth. Van Heddeghem et al. state in [40] that the energy consumption in wired access networks is proportional to the number of connected subscribers, whereas that in backbone networks is more proportional to the traffic volume. Even though this network segment is not the main contributor to PC (small number of devices consuming high power), it will be significantly affected by the increased traffic levels when traversed by increasingly larger traffic volumes. Moreover, the contribution of the backbone network was estimated to account for approximately 8 percent of the total operator's energy consumption.

Bolla et al. also study in [55] the break-down of PC for the different segments of a telecom network. As shown in Figure 3.2, the transport and core networks are responsible for 30 percent of the energy requirements, whereas the access part accounted for 70 percent. Nevertheless, the

authors also predict that the PC of the core network is increasing at a higher pace and will get closer, or even overtake, that of the access part.

As stated in different studies, appropriate measures need to be taken to improve the energy efficiency of all the segments. This thesis sets the focus on approaches to enhance the energy efficiency of the transport network, which will be notably affected by the traffic growth expected for the following years [40]. In this part of the network, the energy is mainly consumed by a set of network elements that need to be deployed: TSPs, OAs, OXCs and REGs.

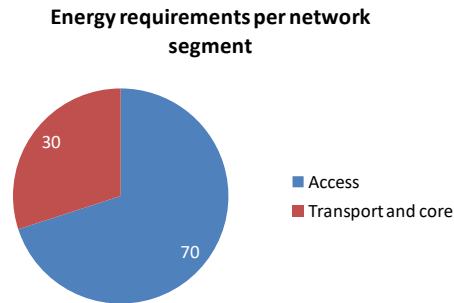

Figure 3.2. Energy requirements in operator networks (based on [55]).

3.1.3. Common approaches for improving energy efficiency

Due to the increased energy cost and interest in the protection of the environment, the topic of energy efficiency has been gaining special momentum in the last years in many diverse fields. For instance, now it is common to classify some electrical appliances (e.g. washing machines, vacuum cleaners) or houses into different categories according to their energy efficiency. In the ICT sector, energy efficiency is also becoming a relevant issue due to the increased popularity of services such as social networks or Internet video and the consequent changes in the user habits. Accordingly, significant effort is being devoted to increase the efficiency in the utilization of energy resources in the ICT sector. Nevertheless, there is plenty of work to be done in this discipline, ranging from reducing the inefficiencies of devices to enhancing the processes related to the operation of ICT services.

The objective of this section is to introduce and survey some of the main publications and approaches dealing with the enhancement of energy efficiency in telecommunication networks in order to provide a general overview of the recent activities within this research area.

3.1.3.1. General papers/surveys on energy efficiency for telecommunication networks

There are several works that attempt to quantify and provide a general overview of the energy efficiency in the different domains of telecommunication networks.

Gupta et al. in [56] and Christensen et al. in [57] published some of the first papers concerning energy consumption of the Internet in 2003 and 2004, respectively. Among other strategies, they propose the idea of sleep-mode for telecommunication networks and establish some analogies with the power-saving techniques used in personal computers and laptops. Since then, this topic has been gaining significant relevance, especially after 2009 when the operators and vendors became more interested after foreseeing the impact of higher energy consumption in the medium- and long-term when the energy cost starts to become a more critical budget item. Some of the publications that focused on fixed networks are presented below.

The group of Professor Tucker in the University of Melbourne (Australia) has been one of the most active players in the field of energy efficiency in telecommunication networks. For example, Baliga et al. presents a comprehensive analytical model to calculate the energy consumption of the Internet considering both the optical and Internet Protocol (IP) layers. In particular, they analyze the energy consumption of the access, metro and core network segments in [39]. Two other publications that greatly motivated the work within this field are references [58-59], published in 2011 by the same group. Both papers quantitatively analyze the lower bounds of energy consumption for telecommunication networks by considering the energy contributions of the different components. In particular, the first part explores more the optical transmission, whereas the second focuses more on optical networking and switching from the physical layer.

Despite the novelty of energy efficiency in ICT as a research field, some publications which survey the most recent approaches have already appeared. These surveys can serve as a good introduction to get an insight into the topic of energy efficiency in telecom networks. Even though the energy efficiency can be optimized at different levels, the surveys are generally broad and attempt to cover a big number of publications. They commonly classify the different approaches into several categories, which also provide a rough idea on how energy can be saved.

One of the first surveys within this field was presented in 2010 by Zhang et al. in [7]. Those authors attempt to gather different approaches to improve the energy efficiency of optical telecommunication networks (including both the access and the core network segments). They state that energy efficiency can be tackled at four different levels: component, transmission, network and application. Moreover, in another survey published in 2011 [55], Bolla et al. estimate the impact of energy consumption for telecommunication networks and survey a set of approaches to improve the energy efficiency of these networks in the future. More specifically, they classify these approaches in three broad groups named as: re-engineering, dynamic adaptation and sleep modes.

Bianzino et al. also present a broad survey which sets the focus on green networking in fixed networks from a high-level point of view in [60]. In fact, they classify the green networking approaches in four different groups: adaptive link rate, interface proxying, energy-aware infrastructure, and energy-aware applications. Additionally, the authors give an overview on the existing work on standardization for energy efficiency.

Dharmaweera et al. published in 2014 another survey focusing on the core and metro segments [61]. This work presents some of the more recent approaches (i.e. until 2014) which were not covered in previous surveys in this field. Similar to other surveys, they categorize the energy-aware approaches into four groups: network redesign, traffic engineering, power-aware networking, and load-adaptive operation.

Some others surveys attempt to not only survey the existing energy-aware approaches, but also quantify the potential energy savings in particular scenarios, usually by means of analytical models. For instance, W. Van Heddeghem et al. published [62] in 2014 where the focus differs from the previously mentioned surveys. In this work, the authors quantify and compare the power savings of different approaches in IP-over-WDM network, providing a detailed analytical model which considers additional factors such as protection or cooling as well.

3.1.3.2. Energy-efficient approaches for the optical transport network

As stated before, energy efficiency can be improved at different levels of telecommunication networks. In this section, the main areas where energy efficiency can be enhanced are described

and some relevant work is referred. Several broad categories from a bottom-up point of view are defined. Even though some of these approaches might be general to telecommunication networks, the focus is mainly set on the optical transport network. It should be mentioned that works specifically related to the areas covered in this thesis will be covered in the corresponding chapters (Chapters 4, 5 and 6).

a) *Energy-aware design of components and network elements*

The devices are the actual energy-consuming elements of the network. As in other disciplines, the energy efficiency of the equipment can be commonly enhanced over time thanks to technology advances (e.g. availability of more energy-efficient complementary metal–oxide–semiconductor (CMOS)). This can be appreciated in the PC figures of the new generation of devices. For instance, new TSPs with higher capacity usually consume more power than those with lower capacity, but they also transmit more data per energy unit.

One of the trends in the development of network elements for the transport networks is based on the introduction of all-optical processing components, which allow for reduced PC with respect to those with electronic processing (e.g. optical switching fabrics, optical wavelength converters, etc.). Improvements can also be achieved by the adoption of new materials for the fabrication of components, performance improvements in the transmission elements (e.g. through a better efficiency in EDFA pump lasers) or software optimization (e.g. DSP algorithms at the receiver).

In fact, the extra power consumed by the equipment inefficiencies and overheads (i.e. ancillary functions that are not critical to the main operation of the network such as air cooling) can be considerably reduced over time with new architectural designs and optimization of the components. This PC overhead is sometimes referred to as the power usage effectiveness (PUE), which is the ratio between total power consumed and the useful power consumed (typically it has a value of 2 in the nodes, while the amplifiers placements outside the node may have a value of approximately 1.5 [62]). These values are certainly not negligible since a factor of 2 implies that for every watt consumed by useful equipment (e.g. TSP), an additional watt is consumed for other tasks. Cooling is indeed the main contributor to this overhead, so that more efficient cooling techniques may certainly reduce the carbon footprint of the ICT sector. Some of these novel cooling techniques have already been studied for data centers [63].

Special interest is being put by vendors to reduce the PC of their products in order to avoid energy consumption to increase at the same pace as the Internet traffic grows, which might entail a significant issue for operators. Recently, the silicon photonics (SiP) technology is being extensively studied and is expected to reduce the PC of devices by means of higher levels of integration of components (e.g. the low-power consuming silicon photonics integrated circuits for coherent TSPs presented in [64]).

Tucker estimates in [58] that the energy per bit of the network equipment is reduced at a rate of 15 percent per annum. Nevertheless, this improvement rate is not directly applied to the total energy efficiency of the network, as most of the equipment is not replaced every year and different generations of technologies may coexist in the network (legacy equipment may certainly have a negative impact on energy efficiency, as they consume more energy per bit than new devices).

Moreover, new techniques can be applied to change the operation of the devices to reduce PC. Currently, the equipment used in the optical transport networks is designed to be always turned-on and consume constant power. This common assumption did not favor the application

of some energy-aware techniques. For instance, by allowing the devices to consume power proportional to the traffic load, the energy consumption could be reduced during low-traffic periods by the application of energy-aware strategies. This is in fact one of the functionalities envisioned for the BVTs used in EON [24]. Furthermore, the implementation of a sleep-mode state (i.e. low-energy state where the device consumes negligible energy) may allow the devices to pass from idle to active state in a short period of time when traffic reaches a specific threshold without significantly affecting the network operation. These hardware capabilities could be enabled by techniques such as power scaling (i.e. power can be adjusted proportionally to traffic load by reducing frequency or voltage of the processors) and idle logic (i.e. quick deactivation of subcomponent when no activity is performed and fast wake up to restart activity) [55].

It should be mentioned that the economic advantages of lower energy consumption are not restricted to lower operational expenses. They can also enable higher integration levels on network equipment boards, which may be translated into lower costs per traffic capacity and less floor space at operator premises.

b) Energy-aware transmission

The communication in optical networks is realized by the transmission of light pulses over the optical fiber. The optical signal is deteriorated along the transmission, but different mechanisms may come in place to improve the signal quality and enable the transmission over long distances. As mentioned, this can be achieved by optical amplification or regeneration (i.e. OAs or REGs). Amplification is normally preferred whenever it is possible as regeneration implies OEO conversions (dedicated per channel) which consume significant amounts of power.

In fact, the extensive application of optical bypass, meaning that traffic not addressed to the node remains in the optical layer without being converted to the electrical layer, may also help reducing PC. An extension of the transparent reach offers a reduction of the number of high-power consuming OEO conversions, as the signal could be transported, amplified and switched directly in the optical domain without being electronically processed. In such a fully transparent network, OEO conversions would only be necessary for the add/drop functionality in the interface between the data equipment and the optical node (i.e. only at the source and destination nodes). The switching energy required in an OXC is two orders of magnitude lower than the equivalent router switching energy [38], leading to a PC reduction between the 25 and 45 percent range [60]. The achieved energy savings may vary according to the scenarios and are strongly related to the need of regeneration in the network, which consequently depend on the dimensions of the network and the transmission systems.

The limitation imposed by the transmission reach becomes an even more stringent factor when moving to higher transmission rates. In future networks, where 400 Gbps connections are expected to be predominant, a large number of regenerations might be necessary to make the transmission possible, which will increase the overall PC of the network. In this context, techniques to extend the transmission reach may eventually improve the energy efficiency as well. Some examples are the deployment of low-attenuation and low-dispersion fibers, low-noise OAs (e.g. distributed Raman amplification), OXCs with low losses or improved DSP and FEC techniques at the receiver to achieve higher compensation for physical impairments.

c) Energy-aware network design approaches

The energy efficiency of the networks can be improved by considering energy consumption in the planning or design stages. In this regard, one of the key points that influence the energy savings

is the traffic pattern, which must be carefully analyzed before dimensioning the network. Some of the energy-aware network design techniques that can be applied are:

- **Network architectures:** Network resources are commonly over-provisioned in order to cope with the possible traffic variations that may occur (i.e. the capacity assigned to a LP may significantly exceed the actual traffic demand). This might become more of a significant issue when upgrading the network with higher-speed TSPs. In order to overcome this inefficiency, a fine matching of the network resources to the traffic demand would be desirable. Introducing MLR operation (i.e. combining the transmission with different LRs in the same fiber) may be a good solution to replace the traditional SLR operation. This scenario is proposed in [65] with the aim of reducing the overall PC. EON can also offer important advantages to achieve a better utilization of the resources by the adaptive rate transmission, as evaluated in Chapter 4.

It is also important to note that more spectral-efficient network architectures may also bring improvements in energy efficiency when considering that larger traffic volumes can be conveyed per fiber, thus reducing the need of deploying new network elements. In fact, this enables ISPs to reduce the number of active parallel fibers and energy-consuming elements like OAs.

- **Static traffic grooming strategies:** Moreover, traffic grooming in WDM networks (i.e. combining different low-rate traffic demands onto a higher capacity LP) can be applied to obtain a better utilization of the resources. This may allow for minimizing the number of LPs traversing the backbone network and eventually enhancing the overall energy efficiency of the network [66].
- **Energy-aware resilience:** DP 1+1, where data are duplicated and transmitted on both paths simultaneously, is the most widely used scheme. This redundancy implies that extra energy is employed for resilience purposes. Some approaches propose the migration from this conventional protection scheme to more energy efficient ones by, for example, sharing backup resources (shared path protection schemes) or putting the backup equipment into sleep mode [67]. However, the latter approach requires short wake-up time of the devices in the occurrence of a failure. The energy efficiency of resilience schemes is evaluated in further detail in Chapter 5.
- **Optimization of the physical topology:** Even though in many cases, the physical topology is already given and it is not possible to install/uninstall the existing fiber cables, some solutions attempt to study this strategy to reduce PC. For instance, Dong et al. show in [68] that PC can be reduced up to 10 percent by such an optimization. The authors show that mesh topology and star topologies could effectively reduce PC.

d) Energy-aware network operation approaches

These approaches attempt to improve energy efficiency by exploiting some of the current inefficiency issues caused by the current operation. These energy-aware strategies may somehow deteriorate the performance of optical transport networks. As a result, they must be carefully assessed in order not to affect the SLA terms and not to make the network unstable.

- **Sleep-mode:** This method is based on partially deactivating or putting some of the devices into a sleep or stand-by mode (low energy state). Thanks to the over-provisioned resources in the network, some node elements could be completely turned off when, for instance, they are neither the source nor destination of the traffic flows and not transfer nodes. Meanwhile, when traffic load is below a certain threshold (e.g. at night), residual traffic

may be rerouted along different links (as mentioned in [7]) to enable the partial deactivation of some network elements. Common approaches tend to shut down as many devices as possible. Sleep-mode has been extensively studied for the IP layer, where this technique can be more easily applied than at the optical layer (as it is designed to be more adaptive to changes). However, in the optical layer, this strategy might not be hitless for the operation of the network, so that the consequences must be carefully assessed not to deteriorate the QoS (i.e. rerouting may imply longer routes where the transparent transmission might be unfeasible, and the elements such as OAs must be ready to be activated in a short period to revert the traffic to the original route if necessary). Some approaches assuming sleep-mode are summarized in [69].

- **Green routing or energy-aware routing:** This strategy takes PC into account for the routing decisions. This can be done by using the PC as a metric instead of the traditional metrics like the number of hops/distance in KSP algorithms. This approach can be complemented by partially deactivating some of the devices or putting them into sleep-mode (i.e. low energy state) when the traffic load is below a certain threshold (e.g. at night), and reroute the traffic over different links. Energy savings between 15 and 70 percent can be achieved in the different surveyed approaches reported in [69].
- **Dynamic operation:** The currently static operation of the transport network may be inefficient. The resources are assigned in a quasi-permanent manner according to the peak traffic rate and the transmissions remain fully active even if the traffic is significantly lower than the peak value. Thus, the devices always consume power according to the peak traffic demands, without considering the potential traffic variations that may occur in the network. In fact, Internet traffic is highly bursty (i.e. users are not always online and even in the moments when they are active, they transmit bursts of traffic and not a constant flow). Operators may take advantage of this effect by statistical multiplexing to make a better utilization of the network resources.

This technique is already exploited in the access network by aggregating the traffic from ADSL subscribers, for example. Adopting a dynamic operation at the optical layer may enhance the utilization of the resources as LPs could be established and released on a demand basis (whenever needed) and thus reduce PC. BoD services may come into place at some point to overcome this inefficiency and achieve a better utilization of resources (in terms of cost and energy consumption). OPS and OBS, which have been under research for some years to replace the current OCS operation, may also offer advantages in terms of reduced PC. The potential savings may depend on the traffic and network scenario as studied by Van Heddeghem et al. in [40]. Those authors conclude that OPS may offer superior performance in energy efficiency than OCS whenever the average node-to-node traffic demands are lower than half the transport line rate.

e) Energy-aware network applications/services

Even if this area is not related to optical transport networks, over-the-top applications running may influence the manner in which networks are designed and operated in the future. Green approaches at the application level may also help improve the overall energy efficiency of the network. For example, considering cloud-computing allows for running tasks requiring high processing at powerful and energy-efficient shared servers, which may eventually reduce the total PC incurred by many less-powerful computers. In addition, the content caching techniques can improve the efficiency of the network if they are carefully assessed (i.e. placing the more accessed contents closer to the users can reduce the energy due to data transportation, but increase the

storage energy [70]). Moreover, from a service perspective, the knowledge of specific service features, geographical distribution or usage patterns, could also be exploited to obtain energy savings.

f) Approaches to reduce emissions

General energy-efficient approaches focus on reducing the nominal PC as a way to tackle the environmental issues derived from rising GHG emissions. However, it must be noted that not all the energy sources have the same environmental impact, i.e. renewable energy such as wind or solar are supposed to be less harmful for the environment than traditional fossil fuels. This matter is considered in some approaches where a set of nodes are powered by green sources of energy to reduce the overall GHG emissions. For instance, in [71] the network elements are placed in locations where renewable energy sources are available, making it possible to achieve zero carbon footprint. Boddie et al. also attempt to minimize the GHG emissions by considering green energy sources in particular nodes in [72].

Furthermore, some works also target the reduction of embodied energy(including manufacturing, maintenance, transportation) together with the operational one. This is an interesting parameter since the additional energy consumed to produce some energy-aware novel devices could be higher than the potential operational energy savings to obtain. For instance, Mata et al. consider the optimization of total energy for different optical network architectures such as fixed-grid WDM networks and EON, showing the significant influence that the deployment of fiber cables has for the total carbon footprint of the network [74]. In particular, EON may offer some benefits in this regard thanks to its reconfigurability, ease of capacity upgrades by software reconfiguration, and the possible transmission of more traffic per fiber. Similarly, Dong et al. also study the embodied energy in a multilayer scenario, reaching similar conclusions [75].

Within this thesis, several approaches are investigated to improve the energy efficiency of optical transport networks, which are mainly focused on optimizing the network design and operation tasks, as summarized in Table 3.1.

Table 3.1. Overview of energy efficiency research areas covered within this thesis.

EA-Network Design	EA-Network Operation
<ul style="list-style-type: none"> ✓ Network architectures with flexible-grid and multiple line-rates ✓ EA-Protection schemes ✓ EA-Routing and resource allocation ✓ EA-Amplifier Placements 	<ul style="list-style-type: none"> ✓ Semi-static operation ✓ Dynamic network operation ✓ EA-Protection schemes

CHAPTER 4. ENERGY EFFICIENCY OF OPTICAL TRANSPORT NETWORK ARCHITECTURES AND OPERATION MODES

Adopting new design approaches for network architectures is one of the most straightforward solutions to improve energy efficiency, but at the same time it can be disruptive with respect to traditional approaches. New network architectures can be introduced partially (i.e. redesigning the network in successive upgrades) or completely (i.e. building a completely new network from scratch). The potential benefits in terms of energy efficiency of the different architectures ranging from traditional fixed-grid WDM networks to EON (flexible-grid) and different modes of operation (i.e. static vs. dynamic) are analyzed in this chapter. Moreover, the network parameters that are mainly used along the entire dissertation are also explained in detail in this chapter.

4.1. Motivation

As mentioned in Chapter 2, current optical transport networks are based on WDM technologies where the information is multiplexed over different wavelengths (colors) as depicted in Figure 2.2. In fact, WDM definitely revolutionized the optical networks by multiplying the capacity that can be transmitted over a fiber in terms of point-to-point transmissions.

Networks are dimensioned according to the traffic requirements of the users, so the traffic pattern plays a relevant role in the design tasks. The information that the network planning departments use is commonly based on real traffic measurements and projections that consider the expected growth of traffic (30-50 percent per annum [3]) to design a network in a way that can support the forecasted traffic requests for several years without requiring additional capacity upgrades.

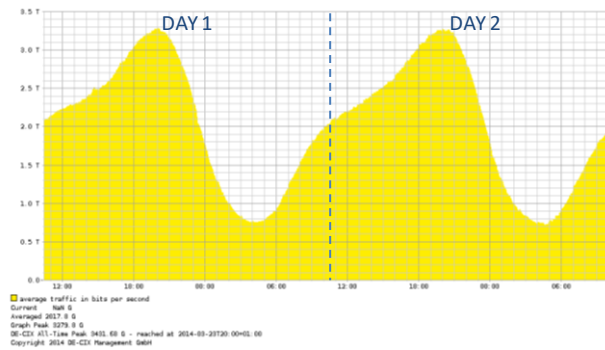

Figure 4.1. Measured traffic on 29th-31st October 2014 at DE-CIX central exchange in Frankfurt (Germany) ([76]).

Network resources are often assigned according to the forecasted end-to-end peak (aggregated) traffic demands among core nodes. In addition, some over-provisioning factor is considered on top of that to allow the network to adapt to unexpected traffic increases. Figure 4.1 represents a real traffic variation at a central exchange of Frankfurt (Germany) during a 48-

hour period [76]. As can be noticed, the peak traffic only occurs during a short period of time per day (7 PM to 9 PM), with traffic being much lower during the other hours. Similar behaviors can be observed for networks of other countries, even though the traffic peaks may be switched to different times of the day. It is also worth mentioning that traffic values at the weekend are frequently lower than on working days.

The architecture of the transport network depends on the operator's decision based on different parameters such as the commercial availability of equipment, cost, traffic conditions, or network topology characteristics.

Traditionally, WDM networks were planned considering a SLR, i.e. using TSPs of the same technology and even from the same vendor for the transmission over the same fiber (operators often build parallel and separate networks with equipment of different vendors). As discussed in Chapter 2, due to the ever-increasing traffic demand, WDM communications systems have evolved towards higher spectrally-efficient solutions over time (i.e. wavelength capacity has increased from 2.5 to 10, 40, and 100 Gbps).

Traffic may not grow at the same pace for all the connections in the network, so that the actual capacity of the network could be exhausted earlier in certain parts of the network. Thus, whenever operators need to upgrade their capacity, they may consider continuing with the SLR approach, by either deploying more TSPs of the currently deployed technology, or building a new SLR network with higher-speed TSPs in different fibers. However, due to the increased heterogeneity of capacity requirements and economic reasons, the transmission with multiple LRs over the same fiber is becoming more frequent, so that WDM networks are operated with MLR. This indeed facilitates a smooth migration towards higher speed networks without requiring the replacement of all TSPs, and provides the operator with different capacity granularities to finely match traffic demands with different throughput requirements. For network planning purposes, it must be considered that the co-propagation of LPs with different MFs may induce non-linear effects on each other (e.g. cross phase modulation) which may reduce the signal quality and thus deteriorate the transmission reach [30]. These potential effects must be carefully assessed.

The selection of TSPs depends on the commercially available ones at the time of installation. Since the LRs must be selected from a discrete set of values, TSPs with higher rate than the requested have to be selected to be ready for potential capacity increases (e.g. a 100 Gbps TSP to provision a 60 Gbps traffic demand). The capacity of these TSPs could be underutilized during most of their lifetime, resulting in a waste of capacity and energy (i.e. they consume constant power and are not proportional to the actual traffic load). On the other hand, BVTs, which are one of the main foundations for EON, will partly provide PC closer to proportional to the load thanks to the adaptive rate functionality. This can be achieved by expanding/contracting the channel bandwidth and/or increasing/decreasing the modulation order.

In fact, the EON paradigm comes in place to solve one of the problems of current fixed-grid WDM networks. The network architectures preserving the rigid channel spacing defined by the ITU-T will suffer from an inefficient utilization of the spectrum when moving to generations of WDM systems beyond 100 Gbps. For instance, in 400 Gbps systems, the signal might not spectrally fit into the 50 GHz spacing (requiring the reservation of several slots of 50 GHz bandwidth). The need for increased network capacity is driving the research community to find alternatives in order to utilize the optical spectrum more efficiently with a good compromise with transmission

reach, and eventually reduce the number of lit fibers and spectrum gaps between channels. EONs, which operate over a flexible-grid instead of the rigid ITU-T grid, are gaining momentum for the operation of the optical layer. The main idea behind EONs is the adaptive line rate, which can be achieved by adapting the bandwidth (symbol rate or number of carriers), and by changing the number of bits/symbol (MF) at the BVT.

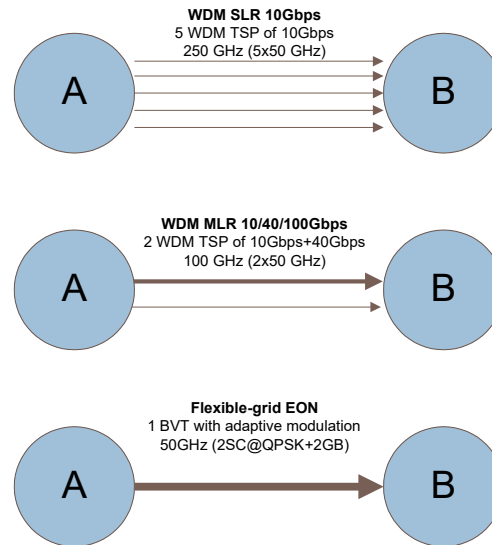

Figure 4.2. Comparison of service provisioning for a demand from node A to node B of 50 Gbps with different network architectures: Fixed-grid WDM SLR 10Gbps; Fixed-grid WDM MLR 10/40/100 Gbps; and EON with adaptive modulation and flexible-grid.

For a particular traffic demand, the spectrum occupancy may vary significantly depending on the assumed network architecture and LRs as shown in Figure 4.2. With increased traffic, moving towards EON seems to be promising in obtaining higher spectral efficiency. However, the benefits may differ depending on the scenario. On the other hand, the energy consumption implications are not obvious. This was one of the motivations to evaluate the potential advantages in terms of energy efficiency of different network architectures.

In current networks, the traffic fluctuations that occur during the day (e.g. the one shown in Figure 4.1) are not reflected in the optical layer which operates in a static manner. LPs are established by tuning the source and destination TSPs to the assigned wavelength(s), i.e. center frequency and channel spacing. LPs then remain active for an undefined period of time, which can be up to several years. During this operation period, the LPs operate at full capacity to be prepared for the forecasted peak traffic (always considering some over-provisioning on top) and TSPs always consume constant power.

The fact that traditional WDM TSPs operate at fixed-rate and consuming constant power entail inefficiencies in terms of capacity utilization and energy consumption. This motivates the research on the potential advantages that dynamic operation modes may bring to future networks. In fact, offering BoD services, i.e. allocating resources according to the traffic requirements, is a promising functionality envisaged for SDN. Analyzing the performance of different network architectures in more dynamic scenarios is part of the work presented in this chapter.

4.2. Related work

In the last few years, many publications evaluating the energy efficiency of different network architectures have appeared. The related work is grouped according to the topics that are covered, highlighting the approaches focused on network design and operation for the optical layer of transport networks.

4.2.1. Energy-efficient design of optical transport network architectures

As mentioned in Chapter 3, there are multiple ways to improve the energy efficiency in optical transport networks (e.g. sleep-modes, technology improvements, etc.). Looking at a single layer design (i.e. the optical layer), SLR offers an inefficient utilization of the network resources, as in many cases the capacity of the wavelengths is not efficiently filled. Overcoming the inefficiency of SLR by adopting MLR operation has been studied to reduce cost, as well as PC.

For instance, Chowdhury et al. compare in [65] and [77] the performances in terms of energy efficiency of IP over an optical layer with MLR (10, 40 and 100 Gbps) and with SLR in opaque, translucent and transparent scenarios. The number of fibers on a physical link, established LPs (taking physical layer constraints into account) and regenerator placement of IP traffic over the virtual topology are used as variables for the mixed integer linear programming (MILP). The results show that MLR can generally reduce the overall PC of the network thanks to a finer adjustment of the provisioned capacity to match the service demand in most of the scenarios. SLR can be more advantageous than MLR only in network topologies with long links, as MLR may require regeneration for the realization of many LPs with high-speed transmissions.

Nag et al. present two strategies, cost- and energy-optimized capacity upgrades for MLR networks in [78], where they consider the impact of service disruption (i.e. the termination of existing physical connections when network upgrades must be performed) in terms of energy consumption. In particular, the maximum amount of disruption is used as a formulation constraint. The results show that by allowing more disruptions to occur, MLR can more efficiently adjust the LRs and thus reduce PC.

The utilization of the network resources may also be enhanced by the application of energy-aware traffic grooming techniques (i.e. combining different low-rate traffic demands onto a higher capacity LP). Van Heddeghem et al. deal with this problem by comparing link-to-link and end-to-end grooming in terms of energy efficiency in [66]. Both types of grooming may bring benefits in terms of energy efficiency, but the superior performance of one or the other grooming schemes mainly depends on the traffic characteristics (e.g. granularity of the client demands, LP capacity, etc.).

As explained in Chapter 2 and in the introduction of this chapter, EON has been recently proposed as a potential technology candidate to overcome the dramatic traffic growth in the optical layer. EON can offer a more efficient utilization of the spectral resources thanks to the flexible spectrum allocation (finer spectrum granularity than the conventional ITU-T grid of 50 GHz used in WDM networks) and the adaptive transmission rate. In fact, the utilization of two novel network elements (i.e. BVT and BV-OXC) will provide more chances to reduce PC.

Concerning the work related to EON architectures, the difference with respect to conventional WDM networks in the network planning tasks (i.e. RWA algorithms used for planning WDM networks are no longer valid for EON) were a great motivation for investigating RMLSA algorithms

with different optimization goals (e.g. spectral efficiency, cost reduction, PC minimization, blocking reduction, etc.). However, despite the overwhelming number of publications related to EON design, only a limited number of references have considered the energy efficiency implications of this novel technology. The majority of those publications focus on estimating the energy consumption of the new elastic devices as well as comparing the overall energy consumption of EON and traditional fixed-grid WDM networks.

In prior work presented in [79-80] (carried out as part of the MSc thesis at the Technical University of Denmark), MLR, SLR and EON in different network topologies are evaluated considering static traffic. The results already show some of the potential advantages brought by the adaptive transmission of EON to reduce energy consumption compared to conventional fixed-grid approaches.

Palkopoulou et al. also investigate in [81] (an extension of [82]) the potential energy efficiency benefits of EON over the rigid WDM technologies (i.e. SLR and MLR). In fact, the authors study two different implementations of OFDM (i.e. electrical and optical) and present a detailed PC model. This comprehensive study gives an insight not only into the energy efficiency, but also the cost and spectrum usage of EON. Moreover, the authors also show that the finer bit-rate granularity of EON can provide lower energy per transported bit than conventional WDM technologies. Regarding the two EON implementations, optical-OFDM is the most energy-efficient solution at low traffic thanks to its fine granularity and scalable PC (dependent on the number of subcarriers) while electrical-OFDM is more energy-efficient at high traffic because of its fixed energy per bit (i.e. PC is fixed and depends on the maximum transmission rate).

Nag et al. also compare the energy efficiency of WDM MLR networks and OFDM-based EON in a dynamic scenario in [83]. In particular, an MILP optimization approach for the design of energy-efficient networks is presented in two particular traffic scenarios (i.e. known and uncertain traffic). The technique considers the occurrence of simultaneous traffic peaks for different source-destination pairs. The results show the great adaptability of EON to efficiently handle the traffic peaks, and the reduction of PC of OFDM-based EON with respect to WDM MLR networks.

In spite of the novelty of the EON paradigm, particular strategies and mechanisms targeting the reduction of energy consumption have also appeared in the literature. For instance, Wu et al. propose a green grooming strategy to improve both the spectral and energy efficiency of OFDM-based EON (only QPSK is considered as MF) [84]. The authors present a comprehensive PC model, an ILP formulation for the static scenario and heuristics for the dynamic one. Significant power savings are reported by this method when compared to a non-grooming routing and resource allocation solution.

In another publication, Khodakarami et al. present in [85] a comprehensive technique to reduce PC in EON by jointly exploiting adaptive modulation and coding (AMC), flexible spectrum allocation, wavelength conversion and traffic grooming. Both MILP and heuristics are proposed to solve the problem with the optimization goal of minimizing PC while satisfying the maximum number of traffic demands with a certain level of QoT. At low traffic, wavelength conversion and traffic grooming are useful to reduce PC (i.e. reduction of the number of TSPs and OAs). At high traffic, AMC outperforms wavelength conversion and traffic grooming as a method to improve energy efficiency.

Some other publications consider the multi-layer interaction between the IP and the optical layers. For example, Klekamp et al. study in [86] (as an extension of [87-88]) the network problem

design of IP over EON. In particular, the cost and PC of flat and hierarchical architectures are compared by using heuristics in IP over WDM MLR and IP over EON considering a FS of 12.5 GHz. The PC of the IP layer is independent of the optical layer technology and the hierarchical or flat topologies. In the optical layer, PC and the number of fibers can be reduced by the hierarchical topology. The WDM MLR approach using a 12.5 GHz offers comparable results in terms of PC to the ones obtained by the OFDM-based EON.

The energy-efficient network design of IP over OFDM-based EON is considered in [89] as well. Ahmad et al. compare the performance of two heuristics to design the logical topology and take advantage of the flexibility given by EON by: (1) Exploiting electronic traffic grooming; (2) Establishing direct LPs. The results point out that an accurate design of the logical topology while considering grooming can bring significant energy savings, especially at low traffic loads in large networks.

Dong et al. compare IP over OFDM-based EON (with 5 GHz subcarriers operating over the ITU-T grid of 50 GHz) and IP over fixed-grid WDM with SLR and MLR in [90]. They present two MILP formulations with different objectives: (1) Minimizing spectrum utilization; (2) Minimizing PC. The simulation results clearly show the superior energy efficiency of EON over fixed-grid WDM networks.

In order to effectively reduce the overall energy consumption of telecommunication networks, the embodied energy (i.e. energy associated with the different processes of a device including its production and maintenance) can also be taken into account in the network design. Mata et al. propose in [91] a variation of the algorithms presented in [79] considering a metric based on both the operational and the embodied energy. Over a 15-year period, EON shows its potential to reduce overall energy consumption over WDM technologies. In [74], Mata et al. extend their work to evaluate the influence of the embodied energy at the client side as well.

4.2.2. Energy-efficient operation of optical transport networks

The operation with multiple or elastic line rates is studied in the context of dynamic networks, where traffic demands vary over time. In the work prior to this PhD thesis, in [80] and [92], dynamic EA-RWA and EA-RMLSA algorithms for SLR/MLR WDM networks and OFDM-based EON are proposed. These preliminary results show some of the potentials of EON to reduce blocking and energy consumption in a dynamic scenario.

Fallahpour et al. propose in [93] a heuristic for an energy-efficient routing and spectrum allocation (RSA) with regeneration placement (RP) in a dynamic scenario. Further, this work presents a detailed analysis of the impact of the MF on the PC of different devices and how transmission power impacts the transmission reach. This approach provides significant improvements in energy efficiency and reductions in blocking with respect to common (non energy-aware) RSA algorithms. The simulation results show that significant improvements in energy efficiency and reductions in blocking probability can be achieved when the energy consumption is taken into account for the resource allocation and RP with respect to the non energy-aware approaches.

Morea et al. present in [94] an energy-efficient operation strategy focused on adapting the transmission (symbol rate and MF) of EON to the requested bandwidth rather than to the peak traffic that they are designed to accommodate. This method also considers the temporary deactivation of some REGs to reduce PC by modifying the symbol rate.

Zhang and Mukherjee introduce a method called time-aware provisioning with bandwidth reservation for the dynamic operation of EON [95]. This technique assumes advanced bandwidth reservation, so that whenever an LP is established, the algorithm tries to reserve as much spectrum as possible for that LP. For the new requests, this strategy attempts to groom as much traffic as possible onto the already established LP from both the time and frequency perspectives to achieve better utilization of the energy and spectral resources.

4.3. General scope

In this chapter, extensive analyses are carried out to compare different network architectures (from fixed-grid WDM networks with SLR and MLR to EONs over a flexible-grid) and operation modes (from static to fully dynamic). The main goals are to assess: (1) In which conditions some network architectures may be favorable over others in terms of energy and spectral efficiency; (2) The implications in energy efficiency of different operation modes and which network architectures can better exploit traffic dynamics. In summary, the most important contributions of this work are:

- (i) Comprehensive description of energy-aware heuristic algorithms for the routing and resource allocation in EON and WDM networks.
- (ii) Evaluation of the performance in terms of energy efficiency per GHz (EEPG) and blocking ratios of different network architectures with fixed- and variable-rate using different frequency plans (fixed-grid vs. flexible-grid) in static and dynamic traffic scenarios.
- (iii) Detailed evaluation of the influence of different parameters for an energy-efficient design of the network.
- (iv) Evaluation in terms of energy efficiency of network architectures in different operation modes ranging from conventional static operation to fully dynamic. An additional intermediate step is considered where semi-static operation is assumed in the so-called traffic-aware and power-aware (TAPA) mechanism, which enables the sleep-mode functionality in the TSPs without modifying the resource allocation.

The work in this chapter was initiated as part of a MSc thesis at the Technical University of Denmark (DTU) in 2011 ([96] and publications in [79-80] and [92]). In [97], those studies were extended by considering several improvements and modifications on the metrics to account for both energy and spectral efficiency and additional scenarios with a comprehensive analysis of the operation modes and frequency plans. Additionally, new scenarios and the influence of different parameters in the energy efficiency of the network are evaluated in this chapter. Part of this work has been reflected in the following publication achieved during this PhD thesis:

1. J. López Vizcaíno, Y. Ye, V. López, F. Jiménez, R. Duque, I. Tafur Monroy, Peter M. Krummrich, "Green Networking and Communications: ICT for Sustainability," *Chapter 17-Energy Efficiency Improvement with the Innovative Flexible-grid Optical Transport Network*, Auerbach Publications- CRC Press, Taylor & Francis Group, ISBN: 978-1-4665-6874-7, November 2013.

4.4. General network parameters

In this section, the common and general parameters used throughout this dissertation are described. The particular parameters of each study are then explained in the corresponding Sections (4.5 and 4.6).

4.4.1. Input and output parameters

The different network architectures are compared from a network design point of view. The main input and output parameters to be considered for the network planning stage are summarized in Table 4.1.

Table 4.1. Input and output parameters for network planning.

Input parameters	Output parameters
<ul style="list-style-type: none"> • Network physical topology: <ul style="list-style-type: none"> ○ Node locations ○ Link information (ingress and egress nodes, number of fibers per link, amplifier locations) ○ Maximum number of wavelengths per fiber ○ Amplifier placements • Network architecture (WDM SLR, WDM MLR or EON), channel spacing (fixed or flexible-grid) and line rates • Traffic information: <ul style="list-style-type: none"> ○ Static traffic – Traffic demand matrix ○ Semi-static operation – Traffic demand matrix and variation ○ Dynamic traffic – Dynamic traffic parameters • Transparent/opaque/translucent • Resilience mechanism • Physical layer model <ul style="list-style-type: none"> ○ Basic model (estimated transmission distance) ○ Advance models based on QoT or required OSNR (ROSNR) • Additional design requirements: <ul style="list-style-type: none"> ○ Symmetrical/Asymmetrical allocation ○ Maximum allowed occupancy per link ○ Other parameters • PC model • Additional parameters (number of KSP, metric, etc.) 	<ul style="list-style-type: none"> • LPs distribution information: <ul style="list-style-type: none"> ○ Selected routes (sequence of nodes and links) ○ Assigned spectral resources identifiers (wavelengths or subcarriers) • Network blocking (number of blocked demands or total blocked traffic) • Performance measures in terms of energy consumption, spectral occupancy, energy efficiency per GHz (EEPG), etc.

4.4.2. Power consumption models

4.4.2.1. Transponders

PC values of 34, 98 and 351 W are assumed for 10, 40 and 100 Gbps WDM TSPs, respectively based on the reference [98]. The BVT used in EON is based on the coherent optical OFDM (CO-OFDM) technology. Due to the commercial unavailability of BVTs, several assumptions have been made to estimate realistic values of the power consumed by such devices. In order to do so, the potential architecture of a BVT is compared with that of a coherent WDM TSP. The main difference is found in the presence of a DSP module at the transmitter part and two DACs, which enable the utilization of different MFs for the transmission. In fact, the DSP module at the transmitter is assumed to be the main difference in terms of PC between both TSPs, and so the overall comparison can be based on the DSP complexity. Given that this complexity is assumed to be similar at the same bit rate according to Savory in [99], the PC is assumed to be the same for both types of TSPs. Accordingly, based on the values of the dual polarization coherent TSPs [98] of 250 and 351 W for 40 and 100 Gbps, respectively (125 and 175.5 W for single polarization); and

assuming that the DSP scales linearly with the bit rate, the PC of a single polarization CO-OFDM BVT (PC_{OFDM}) can be interpolated as a function of its transmission rate (TR) as in Eq. (1).

$$PC_{OFDM}[W] = 1.683 \cdot TR[Mbps] + 91.333 \quad (1)$$

Table 4.2 contains the PC of a BVT for the transmission and reception of a single subcarrier with different MFs. For optical channels composed of more than one subcarrier, the PC will be calculated by the product of the number of subcarriers and the PC of a single subcarrier for the corresponding MF specified in Table 4.2.

Table 4.2. PC values of a CO-OFDM BVT for the transmission and reception of a subcarrier with different MF.

Modulation Format (MF)	Subcarrier Capacity [Gbps]	PC [W]
BPSK	12.5	112.374
QPSK	25	133.416
8QAM	37.5	154.457
16QAM	50	175.498
32QAM	62.5	196.539
64QAM	75	217.581

4.4.2.2. Optical amplifiers

In the studies carried out in this chapter, OAs are assumed to be EDFAs and consume 30 W per direction with an overhead of 140 W per node location [98].

4.4.2.3. Optical Cross Connects

The PC of an OXC in watts depends on the node degree (N) and the add/drop degree (a) as follows: $(N \cdot 85 + a \cdot 100 + 150)$, where 150 W is the overhead [98].

4.4.3. Physical layer constraints

For simplicity sake, the physical layer constraints in these studies are evaluated by an estimated transmission distance value (i.e. checking whether the path length is shorter than the maximum reach assumed for the transmission with a particular MF). More specifically, transmission reaches of 3200, 2200, and 1880 km [80] are assumed for the WDM TSPs of 10, 40, and 100 Gbps, respectively. For EON, transmission reaches of 4000, 2000, 1000, 500, 250, and 125 km [80] are assumed for the transmission of channels with variable bandwidth (N subcarriers x12.5 GHz) with binary phase shift keying (BPSK), QPSK, and QAM of order 8, 16, 32 and 64 (8QAM, 16QAM, 32QAM, and 64QAM), respectively.

4.4.4. Network topologies

The performance of the different network architectures and operation modes has been evaluated in two network topologies that present different characteristics: the Spanish core network model of Telefónica I+D (TID) in Figure 4.3a, and the German core network of Deutsche Telekom (DT) in Figure 4.3b. Transparent reach (no regeneration/wavelength conversion) and single fiber-pair per link are assumed for the present studies. The main characteristics are summarized in Table 4.3. OAs are placed in the network links separated by distances of approximately 80 km.

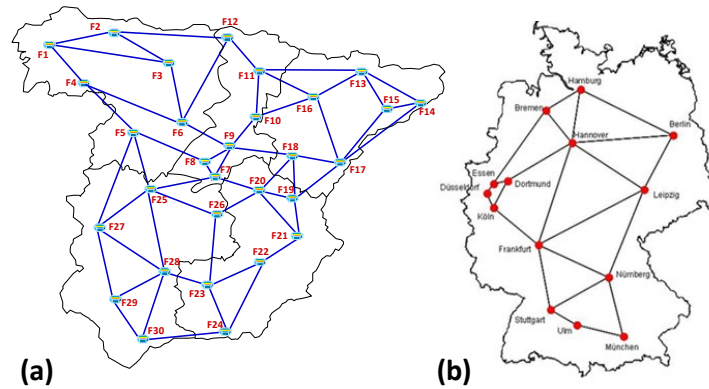

Figure 4.3. (a) TID network [101]; and (b) DT network [100].

Table 4.3. Parameters of network topologies and reference traffic information for the TID and DT networks.

Network parameter	TID Spanish network model	DT German network model
Approximated diameter D [km]	1205	874
Number of nodes No	30	14
Number of bi-directional links Li	48	23
Average node degree ND	3.29	3.23
Number of bi-directional traffic demands	48	91
Overall traffic [Tbps]	3.22	2.8

4.5. Energy efficiency of architectures for optical transport networks

4.5.1. Motivation and scope

This section is devoted to the study in terms of energy efficiency of different network architectures in varied conditions and scenarios. New paradigms such as EON are being proposed to overcome the inefficient utilization of resources of current optical transport networks. The analysis carried out provides an insight into the potential solutions that may be adopted to cope with the increasing traffic demand requirements in an energy-efficient manner. The advantages of the gradual migration to more flexible network approaches by adopting an intermediate solution in between fixed-grid WDM networks and flexible-grid EON are also assessed in this section. Finally, parameter sensitivity analyses are also carried out to evaluate the influence of parameters such as the PC and transmission reach values on the results. It is worth mentioning that since spectral efficiency also has a significant impact in terms of energy efficiency, in many cases both metrics are connected and jointly evaluated by the means of an energy efficiency per GHz (EEPG) metric.

4.5.2. Network parameters

4.5.2.1. Network architectures

- **WDM SLR over fixed-grid with fixed-rate TSPs** (Figure 4.4a): Only one type of TSP with a particular LR (commonly based on the same technology) is used. The considered LRs for this analysis are 40 and 100 Gbps (i.e. a network using only 10 Gbps TSPs might not be realistic for the future traffic levels of core networks, while channels beyond 100 Gbps channels will offer limited transmission reach and certainly exceed the requirements of

most of the end-to-end traffic demands, leading to considerable over-provisioning). The conventional ITU-T grid of 50 GHz is considered, which results in a total number of 80 wavelengths per fiber.

- WDM MLR over fixed-grid with fixed-rate TSPs** (Figure 4.4b): Different types of TSP can be used for the transmission over the same fiber. In this study, a WDM MLR network considering the three most common LR currently available in the market (10, 40 and 100 Gbps) is assumed. As previously mentioned, the transmission with TSPs based on different technologies may impose some limitations on the performance due to the presence of non-linear cross-talk between adjacent channels, which may reduce the transmission distance. For this reason, the C-band is divided into two bands separated by a GB of 200 GHz to minimize the cross-talk effects between the different transmission technologies as proposed in [30]: (1) 10 Gbps transmission with OOK; and (2) 40 and 100 Gbps, which are based on QPSK modulation formats. The position of the GB in the spectrum can be adjusted according to the traffic requirements. Thus, the same transmission reach values considered for a network operating with a SLR (Section 4.4.3) can be assumed in the MLR architecture. The channel spacing is also set to 50 GHz, resulting in a total number of 80 wavelengths per fiber, but using 4 of them as a GB, which eventually reduces the utilizable spectrum.
- EON over flexible-grid with BVTs** (Figure 4.4c): BVTs permit adaptive line rate by modification of the MF and allocation of a variable number of subcarriers. Flexible-grid operation with FS of 12.5 GHz is assumed, i.e. the spectrum is partitioned into frequency chunks of 12.5 GHz, resulting in a total of 320 chunks across the 4 THz C-band. Each of the subcarriers occupies 12.5 GHz and two bilateral GBs of one FS size each are inserted (25 GHz in total). Therefore, the bandwidth of LP could vary from 37.5 GHz (one data and two GB subcarriers) to several hundred GHz (no upper limit on the number of subcarriers per channel is defined). CO-OFDM is considered as the main transmission technique to select MFs with different spectral efficiency values.

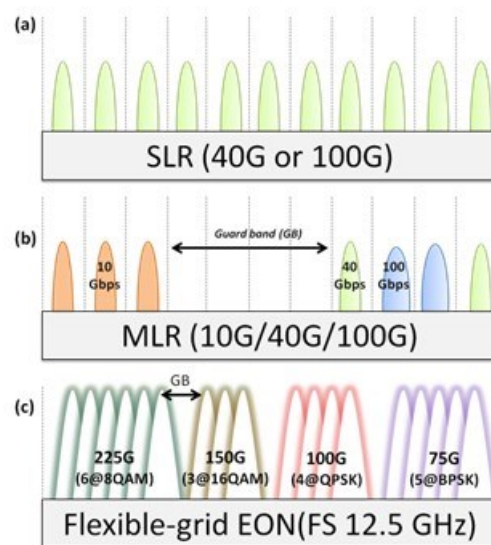

Figure 4.4. Spectrum of the different network architectures: (a) ITU-T grid WDM SLR; (b) ITU-T grid WDM MLR; and (c) Flexible-grid EON.

4.5.2.2. Network operation modes

The comparison of the network architectures has been carried out considering the conventional operation mode of optical transport networks. That is, static operation where the spectral resources are assigned according to the peak-traffic demand in a quasi-permanent manner.

4.5.2.3. Traffic conditions

The traffic demand matrix, which is composed of the aggregated traffic from the clients in that location, is used as a reference and is scaled up several times to emulate different traffic load conditions. More specifically, the traffic matrix of the TID network considers 48 bi-directional demands and a total traffic of 3.22 Tbps, while the DT network takes into account 91 bi-directional demands and accounts for 2.8 Tbps [100] as specified in Table 4.3.

4.5.3. Methodology

Due to the NP-complete nature of the routing and resource allocation problems in large networks and to the wide set of traffic scenarios covered which imply the repetition of many analyses, heuristic algorithms have been proposed to reduce the computational complexity of this study. Indeed, a set of heuristic algorithms for network planning targeted to serve the maximum traffic while optimizing the overall energy- and spectral-efficiency is proposed (extending the ones initiated in [80]). These algorithms take into account the EEPG to select the route and the MF or LR. Single path routing is considered, so that a particular flow request cannot be bifurcated and served over multiple LPs. The operation of the algorithms significantly varies according to the network architecture (WDM with SLR, WDM with MLR or EON), as explained in Section 2.3.

4.5.3.1. Static scenarios

EA-Algorithms for the Static Scenario: Main flow

1. Sort the demands of the TM in descending order of demand value in *ListOfDemands*
 2. $DemandIndex \leftarrow 1$
 3. **while** $DemandIndex \leq size(ListOfDemands)$
 4. Calculate KSP from source to destination and include them in *ListOfPaths*
 5. $HighestEEPGmetric \leftarrow 0$
 6. Initialize *MostEfficientAllocation*
 7. **Evaluation of LP establishment according to the network architecture (see Algorithm 2, Algorithm 3, Algorithm 4)**
 8. **if** *MostEfficientAllocation* exists
 9. Establish LP for *MostEfficientAllocation* (path, resources IDs, LRs/MFs)
 10. **else**
 11. Demand is blocked
 12. **end if**
 13. $DemandIndex \leftarrow DemandIndex + 1$
 14. **end while**
 15. Calculate performance measures (SBR, EEPG)
-

Algorithm 1. Main flow for the EA-Routing and Resource Allocation algorithms in a static scenario.

The main flow of the algorithms used for the static scenario is described in the pseudo-code presented in Algorithm 1.

In the static scenario, the demands are given in a traffic matrix (TM) that contains the information on the nodes which exchange data. The traffic demands are commonly bidirectional (i.e. the same traffic amount is foreseen to be exchanged from node A to node B as from node B to node A). The first step is to arrange the demands in a *ListOfDemands* in descending order of demand value (highest capacity demand first). This is explained by the fact that the most

bandwidth-demanding requests are given higher priority because they are supposed to require more spectral resources (pursuing the ultimate goal of allocating the maximum traffic in the network).

Each of the demands from the *ListOfDemands* is evaluated one-by-one to provision the service and satisfy the requested throughput. Firstly, a set of candidate paths from source to destination nodes (KSP) is obtained by considering the physical distance as a metric (i.e. weights of the links). Since the optimization goal must account for both the energy and spectral efficiency of the network (i.e. as explained before, the spectral efficiency has also an impact on energy efficiency as it determines the amount of traffic that can be transmitted per fiber), an *EEPGMetric* is defined in Eq. (2). This metric allows for selecting the most efficient solution out of the feasible candidates by the ratio between the potential energy efficiency (*EEPath*) and the spectral occupancy (*SOPath*) of the LP. *EEPath* in Eq. (3) is the ratio between the traffic demand value (*TrafficDemand*) and the contribution to PC of the path (*PCPath*). *PCPath* is an indication of the contribution to PC of the LP considering the energy-consuming devices that are necessary for its operation. More specifically, *PCPath* (Eq. (4)) considers the PC of the TSPs (PC_{TRANS}) and an approximation of the power consumed at the links (PC_{LINKS}), including the OAs and OXCs along the path.

$$EEPGMetric \left[\frac{\text{bits}}{\text{Joule}} / \text{GHz} \right] = \frac{EEPath \left[\frac{\text{bits}}{\text{Joule}} \right]}{SOPath[\text{GHz}]} \quad (2)$$

$$EEPath \left[\frac{\text{bits}}{\text{Joule}} \right] = \frac{\text{TrafficDemand}[\text{bps}]}{PCPath[W]} \quad (3)$$

$$PCPath[W] = PC_{TRANS}[W] + PC_{LINKS}[W] \quad (4)$$

The calculation of the EEPG slightly differs depending on the network architecture as explained in the following subsections. In order to select the best solution, two variables are defined: *HighestEEPGmetric*, which contains the maximum value of *EEPGMetric* achieved, and *MostEfficientAllocation*, which stores the information regarding the most efficient allocation for the LP to be established (i.e. routing information, spectral resources to assign, and the LRs or MFs to be used at the TSPs). Thus, once all the feasible alternative solutions have been evaluated, an LP will be established for the most energy efficient combination of path and TSPs configuration (i.e. according to the information stored in the *MostEfficientAllocation* variable). If a solution was not reached, the demand is considered to be blocked and will be taken into account to calculate the service blocking ratio (*SBR*). In particular, *SBR* is obtained by the summation of all the traffic blocked in the network (*BlockedTraffic*) and divided by the total traffic demand (*TotalTrafficDemand*) as defined in Eq. (5).

Other performance measures obtained after evaluating the routing and resource allocation for all the traffic demands are used to compare the different architectures. The overall EEPG is calculated in Eq. (6) and accounts for both energy and spectral efficiency, where *AvgSO* is the average spectrum occupancy of the links in the network, and *BWCBand* is 4000 GHz (C-band spectrum). *EE* is the energy efficiency of the network and is calculated in Eq. (7) by the ratio between the total traffic of the network (*TotalCarriedTraffic*) and the total power consumed by all the energy-consuming devices in the network (*TotalPC*).

$$SBR[\text{percent}] = \frac{\text{BlockedTraffic}[\text{bps}]}{\text{TotalTrafficDemand}[\text{bps}]} \quad (5)$$

$$EEPG \left[\frac{\text{bits}/\text{Joule}}{\text{GHz}} \right] = \frac{EE[\text{bits}/\text{Joule}]}{\text{AvgSO} \cdot \text{BWCBand}[\text{GHz}]} \quad (6)$$

$$EE \left[\frac{\text{bits}}{\text{Joule}} \right] = \frac{\text{TotalCarriedTraffic}[\text{bps}]}{\text{TotalPC}[\text{W}]} = \frac{\text{TotalCarriedTraffic}[\text{bps}]}{\sum PC_{TSP} + \sum PC_{OA} + \sum PC_{OXC}} \quad (7)$$

4.5.3.1.1. EA-RWA for WDM single line rate network

EA-RWA WDM SLR algorithm: Evaluation of new LP establishment for a demand.

1. **for each** candidate path of ListOfPaths
 2. Determine transparent reach possibility (transmission reach \geq path length)
 3. **if** transparent reach
 4. Search for common wavelengths in the links of the path
 5. **if** allocation possible
 6. Calculate *EEPGMetric*
 7. **if** (*EEPGMetric* > *HighestEEPGmetric*) or (*HighestEEPGmetric* = 0)
 8. *HighestEEPGmetric* \leftarrow *EEPGMetric*
 9. Save allocation info (path, wavelengths) in *MostEfficientAllocation*
 10. **end if**
 11. **end if**
 12. **end if**
 13. **end for**
-

Algorithm 2. EA-RWA algorithm for WDM SLR network: Evaluation of new LP establishment.

The different steps to evaluate the establishment of a new LP in a WDM SLR network architecture are presented in Algorithm 2. Whether the TSP provides transparent connectivity for the candidate path is checked first. For those feasible candidate paths in terms of transmission distance, common wavelengths are searched along the links (i.e. wavelength continuity constraint) following the First-fit (FF) strategy (i.e. starting from the wavelengths in the lower part of the ITU-T C-band spectrum). Then, for those LPs where enough common wavelengths are available to serve the traffic demand, an *EEPGMetric* is calculated in Eq. (2) by the ratio between *EEPath* and *SOPath*. *EEPath* is obtained by Eq. (3) and *SOPath* is given by the product of the number of wavelengths *No λ s* and the channel spacing (e.g. 50 GHz when ITU-T grid is assumed) as shown in Eq. (8). For the calculation of *PCPath* in Eq. (4), *PC_{TRANS}* is obtained in Eq. (9) by multiplying *No λ s* and the PC of a single TSP for the used LR (*PC_{WDMTSP}*). On the other hand, *PC_{LINKS}* is calculated in Eq. (10) by the product of the proportion of resources that a potential LP would occupy in the links (ratio between *No λ s* and the total number of wavelengths in a fiber-*TotalNo λ s*) and the summation of the PC of the OAs (*PC_{OAsLP}*) and OXCs (*PC_{OXC_{sLP}}*) traversed by the LP. For these two last contributions, the PC overheads per node and amplifier location are also taken into account. *TotalNo λ s* depends on the selected channel spacing (e.g. 80 wavelengths for the ITU-T grid of 50 GHz). Finally, among the feasible paths, the one providing the *HighestEEPGmetric* is selected and the corresponding wavelengths are assigned.

$$SOPath[\text{GHz}] = No\lambda s \cdot ChannelSpacing[\text{GHz}] \quad (8)$$

$$PC_{TRANS}[W] = No\lambda s \cdot PC_{WDMTSP}[W] \quad (9)$$

$$PC_{LINKS}[W] = \frac{No\lambda s}{TotalNo\lambda s} (PC_{OAsLP}[W] + PC_{OXC_{sLP}}[W]) \quad (10)$$

4.5.3.1.2. EA-RWA for WDM mixed line rate network

The EA-RWA for MLR entails some significant differences with respect to that of SLR, as detailed in Algorithm 3. As explained in Section 4.5.2.1, the optical spectrum is divided into two wavebands (i.e. one for 10 Gbps and the other one for both 40/100 Gbps connections) to diminish the crosstalk between channels based on different technologies. The assignment in the first waveband follows the FF algorithm, whereas the second waveband's assignment follows the Last-

fit strategy (i.e. assigning the highest indexes first). These two different allocation strategies would allow for a movement of the 200 GHz GB to increase the number of wavelengths in a particular band if required by traffic conditions, i.e. whether more 10 Gbps wavelengths than 40/100 Gbps are required or vice-versa.

EA-RWA WDM MLR algorithm: Evaluation of new LP establishment for a demand.

1. Calculate the possible *LRComb* for *TrafficDemand* and sort them in descending order of TSP's *EEPG* in *LRCombList*
 2. *LRCombIndex* ← 1
 3. **while** *LRCombIndex* ≤ size(*LRCombList*)
 4. **for each** *candidate path* of *ListOfPaths*
 5. Determine transparent reach possibility (reach of the highest line rate ≥ path length)
 6. **if** *transparent reach*
 7. **if** 10G in *LRComb*
 8. Search for common wavelengths in the 1st band of the links
 9. **if** *allocation not possible*
 10. Search for common wavelengths by moving the GB to the right
 11. **end if**
 12. **end if**
 13. **if** 40G/100G in *LRComb*
 14. Search for common wavelengths in the 2nd band of the links
 15. **if** *allocation not possible*
 16. Search for common wavelengths by moving the GB to the left.
 17. **end if**
 18. **end if**
 19. **if** *allocation possible in the two wavebands*
 20. Calculate *EEPGMetric*
 21. **if** (*EEPGMetric* > *HighestEEPGMetric*) or (*HighestEEPGMetric* == 0)
 22. *HighestEEPGMetric* ← *EEPGMetric*
 23. Save allocation info (path, wavelengths, *LRComb*) in *MostEfficientAllocation*
 24. **end if**
 25. **end if**
 26. **end if**
 27. **end for**
 28. **if** *HighestEEPGMetric* ≠ 0
 29. *Break*
 30. **end if**
 31. *LRCombIndex* ← *LRCombIndex* + 1
 32. **end while**
-

Algorithm 3. EA-RWA algorithm for WDM MLR network: Evaluation of new LP establishment.

In an MLR network, different line rate combinations (*LRComb*) can be selected to serve a particular traffic demand (*TrafficDemand*). These combinations are calculated and sorted in a list (*LRCombList*) in descending order of *EEPG* at the TSPs (i.e. considering only the PC of the TSPs and the number of channels required to provision the service). Then, the evaluation is started from the first possible *LRComb* in *LRCombList* (i.e. the one providing the highest *EEPG*) in those candidate paths with transparent reach feasibility (i.e. the highest line rate in *LRComb* is the most restrictive in terms of reach, so it will determine whether the transmission can be done transparently). After that, the WA process starts by searching for available 10 Gbps wavelengths in the first band and 40 and 100 Gbps wavelengths in the second. As for WA, the GB (initially placed in the middle of the C-band spectrum, for instance in wavelengths 39-42 with the ITU-T grid of 50 GHz) can be moved if necessary. For those candidate paths where the allocation is feasible, an *EEPGMetric* is calculated similarly to EA-RWA for SLR (Eq. (2-4), Eq. (8) and Eq. (10)), but PC_{TRANS} is calculated as in Eq. (11) where $10G\lambda_s$, $40G\lambda_s$, $100G\lambda_s$, correspond to the numbers of WDM TSPs of 10, 40 and 100 Gbps, respectively. In addition, the *PCT10G*, *PCT40G* and *PCT100G* correspond to the PC of WDM TSPs of 10, 40 and 100 Gbps, respectively.

After evaluating the WA in all the candidate paths, the most energy-efficient per spectral unit solution (i.e. combination of $LRComb$ and candidate path) is selected. Otherwise, the procedure is repeated for the rest of $LRComb$ in the $LRCombList$.

$$PC_{TRANS}[W] = 10G\lambda_s \cdot PCT10G[W] + 40G\lambda_s \cdot PCT40G[W] + 100G\lambda_s \cdot PCT100G[W] \quad (11)$$

4.5.3.1.3. EA-RMLSA for the OFDM-based elastic optical network

EA-RMLSA EON algorithm: Evaluation of new LP establishment for a demand.

1. **for each** candidate path of $ListOfPaths$
 2. Determine possible mod. formats (transmission reach \geq path length)
 3. **for each** feasible MF
 4. Calculate $NoSubcPath \leftarrow NoDataSubc + GB$
 5. Search $NoSubcPath$ contiguous subcarriers in the links of the path
 6. **if** allocation possible
 7. Calculate $EEPGMetric$
 8. **if** ($EEPGMetric > HighestEEPGMetric$) or ($HighestEEPGMetric == 0$)
 9. $HighestEEPGmetric \leftarrow EEPGMetric$
 10. Save information in $MostEfficientAllocation$
 11. **end if**
 12. **end if**
 13. **end for**
 14. **end for**
-

Algorithm 4. EA-RMLSA algorithm: Evaluation of new LP establishment.

The EA-RMLSA algorithm proposed for EON assumes that the spectrum is divided in a flexible-grid fashion (i.e. into fine FSs of 12.5 GHz) and that the installed equipment is bandwidth-variable and fully compliant with signals whose bandwidth is a multiple of 12.5 GHz. The procedure to evaluate the RMLSA for a particular traffic demand is described in Algorithm 4. As shown, the allocation is evaluated for the feasible combinations of path and MF (i.e. MF providing a longer transmission reach than the length of the path). In addition to the physical layer constraints, the spectrum continuity and contiguity must be fulfilled as well (see constraints for EON in Section 2.3.5). For this purpose, a common block of contiguous subcarriers is searched in the links of the path following the FF packing algorithm. The size of the block ($NoSubcPath$) is determined by the required number of data subcarriers $NoDataSubc$ (i.e. traffic demand divided by the capacity of a single subcarrier for the corresponding MF) plus the bilateral GB, one subcarrier at each side of the block.

If there are enough free contiguous spectral resources for the subcarriers in all the links of a candidate path, the $EEPGMetric$ is calculated for that MF and path as in Eq. (2). $EEPath$ is obtained as in Eq. (3), while $SOPath$ is given by the product of the number of subcarriers $NoSubcPath$ (including data and GB subcarriers) and the FS as in Eq. (12). In order to calculate $PCPath$ as in Eq. (4), PC_{TRANS} is given in Eq. (13) by the product of the number of data subcarriers ($NoDataSubc$) and the PC of a single subcarrier for the corresponding MF (PC_{SUBC}) of Table 4.1. Meanwhile, PC_{LINKS} is obtained in Eq. (14) by the product of the proportion of resources that a potential LP would occupy in the links (ratio between $NoSubcPath$ and the total number of subcarriers in a fiber $TotalNoSubc$) and the summation of the PC of the OAs (PC_{OA}) and OXCs (PC_{OXC}) traversed by the LP. $TotalNoSubc$ is equal to 320 if the FS is equal to 12.5 GHz.

$$SOPath[GHz] = NoSubcPath \cdot FS[GHz] \quad (12)$$

$$PC_{TRANS}[W] = NoDataSubc \cdot PC_{SUBC}[W] \quad (13)$$

$$PC_{LINKS}[W] = \frac{NoSubcPath}{TotalNoSubc} (PC_{OASLP}[W] + PC_{OXCSLP}[W]) \quad (14)$$

The previous procedure is repeated for all the candidate paths, and the *EEPGMetric* is only obtained for those feasible combinations of path and MF which allows for selecting the most energy- and spectral-efficient solution if more than one are available (i.e. comparing the different values of *EEPGMetric* and selecting that providing the highest value).

4.5.4. Numerical results

4.5.4.1. Comparison of network architectures

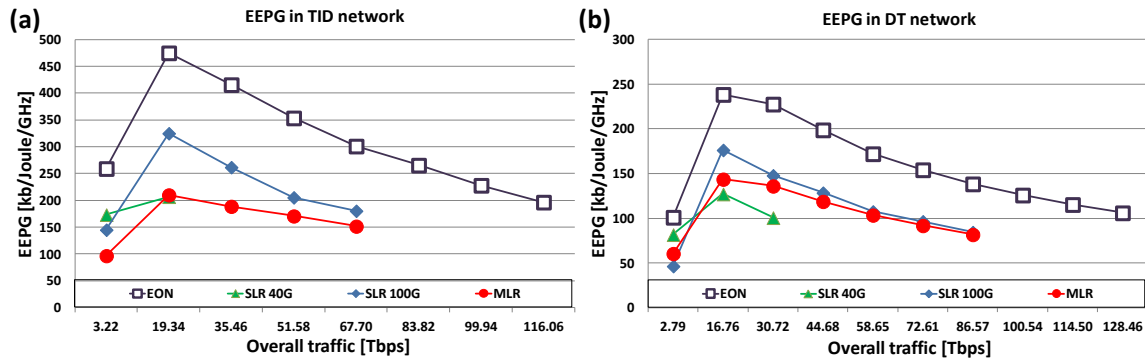

Figure 4.5. EEPG –Comparison of network architectures in: (a) TID network and (b) DT network (results are not shown for those traffic scenarios where blocking exists).

As discussed, in order to assess the influence of the network topology on the results, the analyses have been carried out for two nation-wide topologies of European operators. The static traffic demand matrices have been scaled up to emulate higher traffic volumes. The network evaluated architectures are the fixed-grid WDM networks (compliant with the ITU-T grid of 50 GHz), and an OFDM-based EON network over a flexible-grid frequency plan.

The simulation results in terms of EEPG at different traffic load values under no blocking conditions (i.e. when SBR is zero) are presented for the TID and DT networks in Figure 4.5a and Figure 4.5b, respectively. These figures give an insight into the energy efficiency, spectral efficiency and SBR measures.

As can be seen, the performance of the different network architectures leads to analogous conclusions in both topologies. Despite the fact that similar patterns can be observed in the two network topologies, some difference can be observed in the EEPG results due to the different dimensions of the topologies, and, especially, to the different number of links and nodes. In fact, the values of *EEPG* are considerably higher for the TID network than for the DT, which is explained by the lower average spectrum usage in the TID network (i.e. similar amount of traffic is scattered across a larger number of links, which results in a lower average spectral occupancy).

The EEPG is strongly affected by the values of overall traffic. In fact, three different stages can be appreciated: (1) Low traffic range where there is high over-provisioning since the capacity of the TSPs is not efficiently used; (2) Medium traffic range where EEPG increases with traffic load thanks to a more efficient wavelength capacity “filling”; and (3) High traffic range where the overall EEPG decreases due to the increase of spectral occupancy. As earlier explained, the EEPG results are affected by two dimensions: spectral occupancy and energy consumption. Before proceeding with the analyses of the EEPG, the results in terms of only energy efficiency (EE) are

presented to assess the influence of each dimension independently (i.e. Figure 4.6a and Figure 4.6b for the TID and DT networks, respectively). As can be noticed, the EE values of the different architectures are not very different from each other. At low traffic, SLR 40G is the most energy-efficient solution as the TSP of 40 Gbps provide lower energy per bit than the other technologies, but its limitation in capacity makes the network congested as soon as traffic grows. On the other hand, SLR 100G is clearly penalized in terms of EE by the high over-provisioning levels (i.e. the low demand values do not justify the use of such a high-capacity in most of the LPs). This low utilization of the wavelength capacity has a negative impact on EE as the TSPs consume constant power regardless of the occupancy of the wavelength capacity. At high traffic load values (when the average traffic demand is above 100 Gbps) SLR 100G, MLR and EON offer similar EE results. SLR 100G is slightly worse than the other two technologies as it offers a coarser granularity, while in EON and MLR the capacity can be more finely adapted to the throughput requirements. The minor differences observed in the two topologies are explained by the different traffic and topology parameters (e.g. the differences in average demand and the transmission distances which may determine the selection of LR or MF).

When taking spectral efficiency into consideration (see results in terms of EEPG in Figure 4.5), similar performance is also observed for the various architectures in both topologies. At low traffic, SLR 100G is clearly penalized by its worse energy efficiency, but as traffic increases, the EEPG of SLR 100G is significantly enhanced and overcomes that of MLR. This is explained by the presence of a GB in MLR which obviously has a negative impact on spectral efficiency (i.e. 200 GHz of spectrum cannot be used for data transmission). As for EON, despite offering similar EE to MLR and SLR 100G, it clearly outperforms the other architectures in terms of EEPG. This is especially noticeable when traffic increases as it is possible to use higher order MFs with lower energy consumption per bit (see Table 4.2), and the creation of “super-channels” which offer remarkable spectral occupancy reductions.

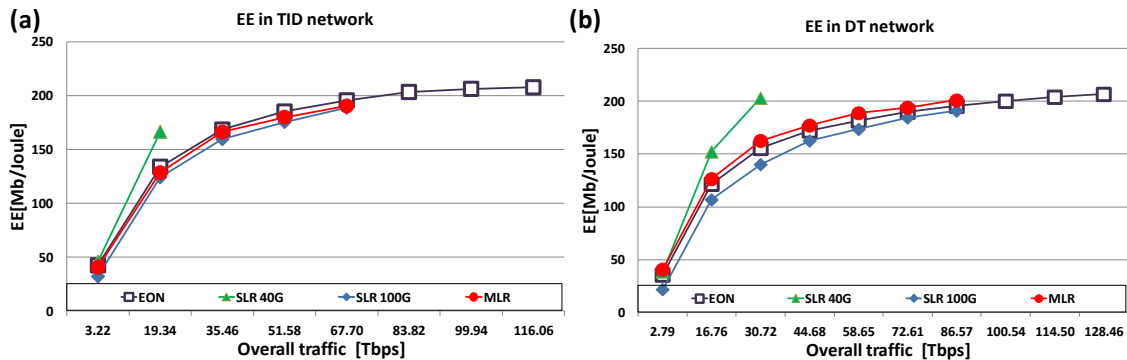

Figure 4.6. EE –Comparison of network architectures in: (a) TID network and (b) DT network (results are not shown for those traffic scenarios where blocking exists).

As traffic increases further, the network starts experiencing congestion in some areas, and some traffic demands are blocked due to the unavailability of spectral resources. As explained earlier, the SBR measure is also important from the energy efficiency point of view as it actually determines the number of devices that are necessary to operate at a given traffic load. The SBR measures are presented in Figure 4.7a and Figure 4.7b for the TID and DT networks, respectively. Considering the same traffic growth and different network architectures, blocking will firstly occur for SLR 40G, then for MLR and SLR 100G, and finally for EON. EON will indeed permit to convey more traffic in a single fiber-pair network than any fixed-grid WDM approach thanks to its superior

spectral efficiency. According to the SBR results, EON can offer an overall capacity larger than 116 Tbps and 128 Tbps in the TID and DT networks with a single fiber-pair per link, respectively. MLR shows slightly higher SBR than SLR 100G due to the presence of the GB, which reduces the utilizable spectrum for transmission.

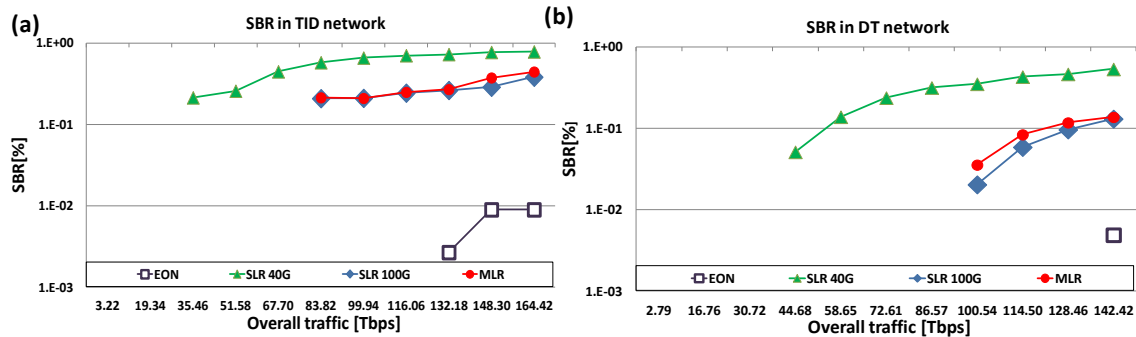

Figure 4.7. SBR – Comparison of network architectures in: (a) TID network and (b) DT network (results are not shown for those traffic scenarios where blocking exists).

4.5.4.2. Gradual migration to more flexible architectures

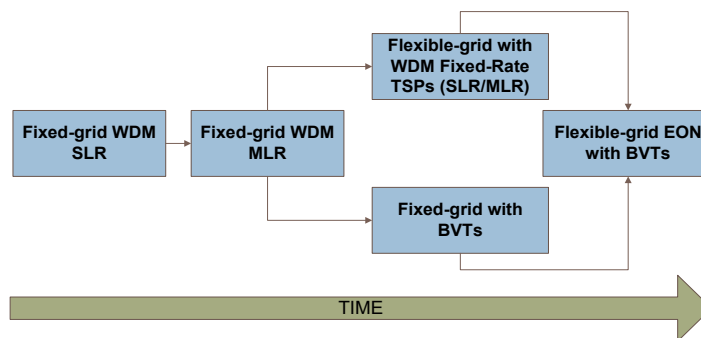

Figure 4.8. Expected evolution of the network architectures for optical transport networks.

In the previous section, different architectures are compared considering the employment of the TSPs for the scenarios they were designed for, i.e. fixed-rate WDM TSPs working with the ITU-T grid of 50 GHz, and BVTs working over a flexible-grid frequency plan (i.e. EON). As discussed, the EON architecture shows a superior performance in terms of energy and spectral efficiency based on the combination of two disruptive concepts with respect to conventional WDM networks, i.e. the BVTs with adaptive line rate and the flexible-grid frequency plan. However, in the evolution towards flexible deployment networks scenarios, two intermediate scenarios could come in place as presented in Figure 4.8:

- Flexible-grid with WDM fixed-rate TSPs:** Conventional WDM technologies could also take advantage of the flexible-grid concept. Thus, existing fixed-rate WDM TSPs, designed to operate with a fixed-grid of 50 GHz, could reduce the assigned spectrum to increase the overall capacity of the network by using BV-OXCs. In fact, the channel bandwidth could be significantly reduced with flexible-grid and some re-design in the TSPs (e.g. 10 Gbps signal could fit into one single FS [86], 40 Gbps in 2 FS and 100 Gbps in 3 FS [102]). Nonetheless, it is worth mentioning that switching signals with bandwidths as fine as 12.5 GHz might be not physically feasible in OXCs which commonly assume a larger minimum bandwidth. One

of the main drawbacks of this approach is the reduction of the transmission reach due not only to the filtering stages that the LPs need to traverse, but also to the potential inter-channel interference (i.e. the performance of these technologies is optimized to operate with the ITU-T grid of 50 GHz). Some studies assume a reduction on the transmission reach, which could be overcome by the insertion of a GB (e.g. 10 GHz) to diminish the penalties [13] [103]. Based on the previous reasons and to make a fair comparison with EON, the channel spacing has been decreased from 50 GHz to 37.5 GHz. This bandwidth is equivalent to the minimum bandwidth of an optical channel in EON (i.e. one data subcarrier and two bilateral GBs). As the bandwidth reduction is not very significant (12.5 GHz), the same transmission reaches as those of the conventional ITU-T grid of 50 GHz have been assumed for this study (the GB in MLR is still present to avoid inter-channel interference among the different transmission generations). Theoretically, the capacity of the network could be increased by up to 33 percent (106 wavelengths instead of 80).

- **Fixed-grid with BVTs:** The line rate adaptability of the BVTs can be exploited with a fixed-grid configuration assuming that the “super-channel” bandwidth is constrained to be an integer multiple of 50 GHz (only fixed-grid OXCs are deployed in the network). This scenario would permit the reuse of the legacy fixed-grid OXCs deployed in the network. Appropriate modifications are applied to Algorithm 4 to enable the operation of BVTs with the fixed-grid of 50 GHz, i.e. all the channels are forced to occupy multiples of contiguous blocks of 4 FS of 12.5 GHz to make them compliant with the frequency plan and equipment working with the fixed-grid of 50 GHz.

These two intermediate networking steps could be initially applied in different domains in the network for a gradual migration from conventional to future EON architectures as explained in Section 2.1.3.2.

Figure 4.9a and Figure 4.9b compare the EEPG of network architectures with different frequency plans for the TID and DT networks, respectively. Moreover, Figure 4.10a and Figure 4.10b shows the SBR of TID and DT networks, respectively. The term “Fixed” refers to the operation over the conventional ITU-T grid of 50 GHz, whereas “Flex” assumes the network architecture with flexible-grid. As presented, the approach with BVTs operating over a flexible-grid (“BVT-Flex” which corresponds to the “EON” approach presented in the previous sections) shows the most remarkable performance in terms of EEPG in both topologies and also provides significantly lower SBR with its great adaptability (i.e. adaptive line rate by expanding/contracting bandwidth and increasing/decreasing the modulation order). A network using BVTs with a fixed-grid of 50 GHz (“BVT-Fixed”) can still offer remarkable results in terms of EEPG, which can even outperform the ones obtained by conventional WDM fixed-rate TSPs working with flexible-grid, thanks to the flexibility in the rate adaptation provided by the BVTs.

For the WDM networks with fixed-rate TSPs, the results show that the EEPG can be significantly increased and SBR reduced when moving to a more flexible spectrum configuration. Particularly, the EEPG provided by WDM SLR of 100 Gbps can be remarkably enhanced with flexible-grid since it offers a similar performance to that of EON over fixed-grid. In fact, the EEPG improvements obtained by adopting flexible-grid operation are mainly coming from the reduced spectrum occupancy. This also brings lower SBR since more traffic demands could be successfully provisioned in the network (Figure 4.10). In general, both the variable modulation formats (offered by the BVT) and the flexible-grid operation contribute to making EON more spectral- and

energy-efficient than conventional fixed-grid WDM networks (as shown in Figure 4.5). The BVTs allow for a fine adjustment of the power consumption to the demand, while the flexible-grid helps to optimize the spectrum utilization and reduce SBR.

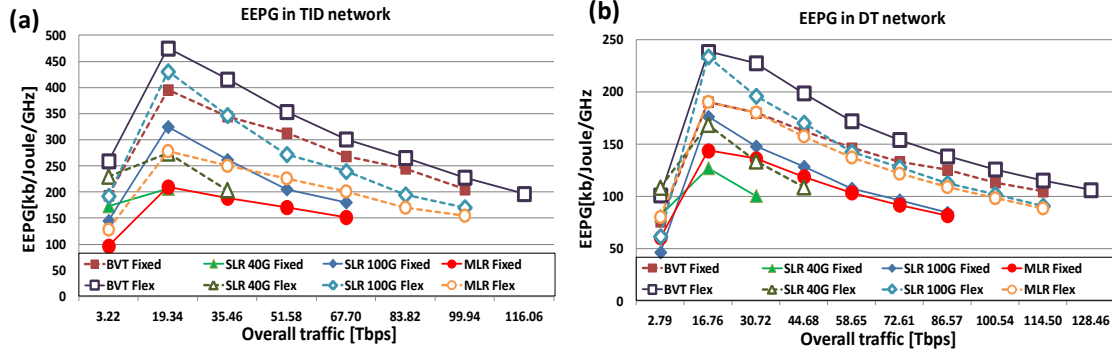

Figure 4.9. EEGP – Comparison of network architectures in unprotected static scenario for: (a) TID network; and (b) DT network.

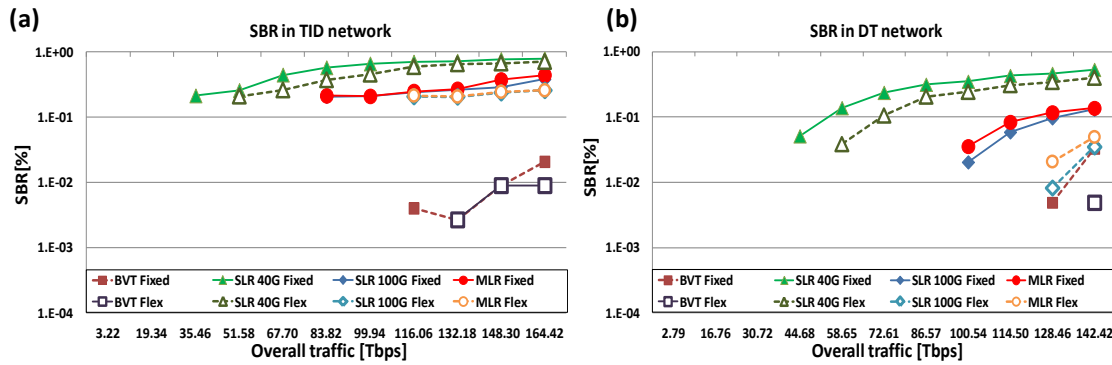

Figure 4.10. SBR - Comparison of network architectures in unprotected static scenario for: (a) TID network; and (b) DT network.

4.5.4.3. Parameter sensitivity analyses

After evaluating the performance of network architectures with the network parameters presented in Section 4.4, this section aims at validating the obtained results and conclusions. For this purpose, several parameter sensitivity analyses are carried out considering variations on some of the values. The parameter sensitivity analyses are presented only for the TID network topology with static traffic conditions, but the conclusions could easily be extrapolated to other network topologies and network operation modes.

4.5.4.3.1. Power consumption of the WDM transponders

The potential energy savings of any approach highly depend on the assumptions made to estimate the PC of each network element. Especially the PC values of the TSPs have a significant impact on the energy consumption results. Accordingly, this section studies the sensitivity of the results to the PC of the WDM TSPs. Figure 4.11a and Figure 4.11b show the EEGP for the TID network for SLR 40G and SLR 100G by modifying the PC of the TSP of 40 Gbps and 100 Gbps, respectively. The EEGP values obtained with EON are also shown in the figures for the sake of comparison.

The initial value assumed for a TSP of 40 Gbps is 98 W (Section 4.4.2.1). The results show that SLR 40G can become significantly more energy-efficient if the PC of a 40 Gbps TSP is reduced below that value (e.g. to the 25 or 50 percent of the initial value). However, even with decreased PC at the TSPs, EON would still offer superior performance in terms of EEPG (if the current PC values of a BVT are maintained). This is explained by the much higher spectral efficiency of EON with respect to SLR 40G (i.e. the network with SLR 40G becomes almost fully utilized at low traffic as shown in the SBR results of Figure 4.7).

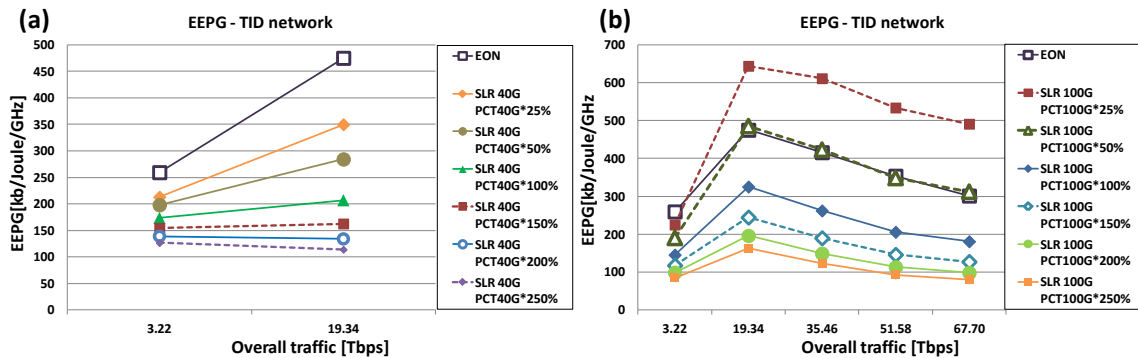

Figure 4.11. EEPG - Parameter sensitivity analysis of the PC of a WDM TSPs in the TID network for: (a) SLR 40G varying the PC of a 40 Gbps TSP; and (b) SLR 100G EEPG varying the PC of a 100 Gbps TSP.

For SLR 100 Gbps networks, the PC of the TSP strongly affects the EEPG of the network as well. The considered PC value is 351 W (Section 4.4.2.1). This scheme shows very good performance in terms of spectral efficiency (especially at high traffic) but consumes significantly more power. Nonetheless, as shown in Figure 4.11b, SLR 100G may become more EEPG than EON only if the PC of the 100 Gbps TSP is decreased by at least 50 percent with respect to the assumed value. Even in that scenario, SLR 100G suffers from high over-provisioning when traffic is low and might not be spectral-efficient enough at high traffic, when the average demand increases over 100 Gbps if several ITU-T slots have to be provided per traffic demand. Moreover, SLR 100G suffers from higher SBR than EON independently of the power consumed by the TSPs, which may be disadvantageous when considering the total traffic that can be conveyed per fiber. It is also worth mentioning that the PC of the BVT was calculated as a function of the values assumed for a 100 Gbps TSP, so that PC values for the EON might also decrease accordingly.

The EEPG results for the TID network with MLR architecture are shown in Figure 4.12 considering a variation of the PC values of the TSPs of 40 and 100 Gbps (10 Gbps remains constant with a value of 34 W). The EEPG performance in this case depends on more than one factor (i.e. PC values of the different TSPs). Therefore, it is more difficult to see a clear tendency in terms of PC parameter sensitivity. Clearly, the smaller the PC values, the larger the EEPG results that can be achieved by MLR.

Nevertheless, it can be observed that when compared to EON, only those scenarios considering significantly low PC values (e.g. 25 percent of the initially assumed PC values for both TSPs of 40 and 100 Gbps) can provide higher EEPG than EON at high traffic. Only in those scenarios, the low power consumed by the TSPs would compensate for the worse spectral efficiency of MLR with respect to EON. Otherwise, the smarter utilization of spectral resources of EON architectures will favor the performance in terms of EEPG, as shown in the simulation results obtained in Section 4.5.4.1. It should also be mentioned that some MLR scenarios where the PC values of the TSPs of

100 Gbps are reduced (e.g. 50 percent of their initial value) may provide similar EEPG values to EON at high traffic load. This is explained by the fact that the *LRCComb* are selected based on a metric that accounts for the EEPG of the TSPs. With the PC figures for a TSP of 100 Gbps being low, more TSPs of this rate will be used in the *LRCComb* and thus the overall PC and spectral occupancy will be reduced.

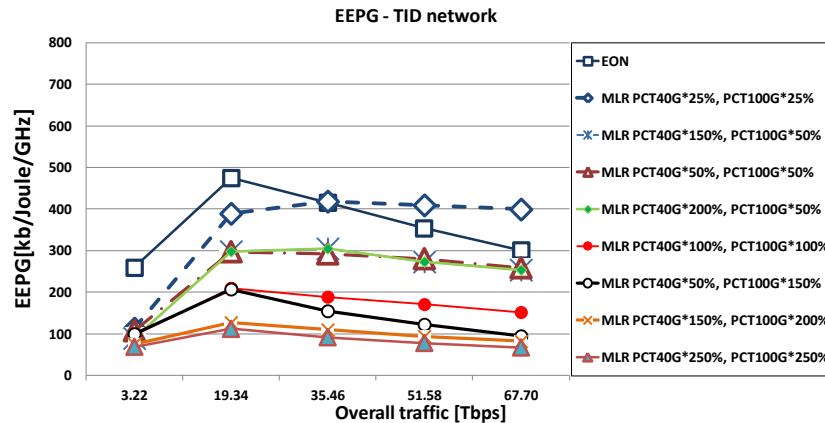

Figure 4.12. EEPG - Parameter sensitivity analysis of the PC of a WDM TSPs in the TID network for MLR (10/40/100 Gbps) varying the PC of 40 Gbps and 100 Gbps TSPs.

4.5.4.3.2. Power consumption of a bandwidth variable transponder in EON

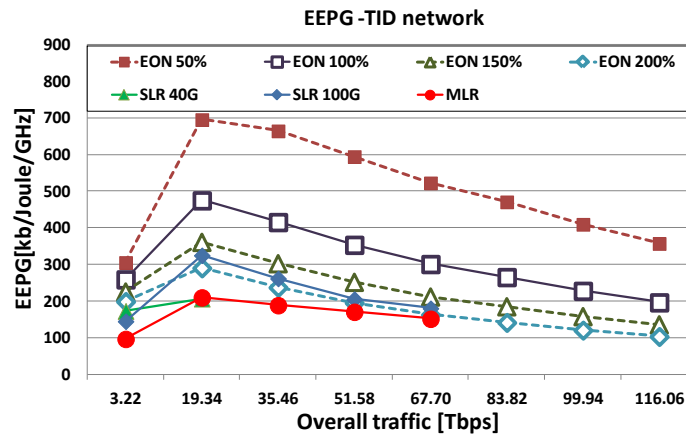

Figure 4.13. EEPG - Parameter sensitivity analysis of the PC of a BVT in the TID network for EON architectures.

EON is shown as a promising energy-efficient architecture for optical transport networks as discussed in Section 4.5.4.1. As mentioned earlier, the TSPs are the main contributors to the overall PC of the network. In order to assess whether the remarkable performance of EON could be influenced by the assumed PC model, the PC values of a BVT have been varied in a range between 50 and 200 percent with respect to the ones presented in Table 4.2.

The results in terms of EEPG of EON with different BVT PC are compared with conventional WDM networks in Figure 4.13. As shown, EON would continue showing higher EEPG even if the BVTs consume 50 percent more power (“EON 150%”). Obviously, halving the PC of a BVT (“EON 50%”) would enhance the overall EEPG of the network. On the other hand, if the PC of the BVT is doubled (“EON 200%”), SLR 100G could overcome EON in terms of EEPG. Nevertheless, it is worth

mentioning that the spectrum efficiency benefits (which eventually affect EEGP when the total traffic per fiber is considered) are independent of the PC values of the BVT. Therefore, thanks to its lower SBR, EON would still be a promising architecture in terms of EEGP even consuming considerably more power than WDM approaches (e.g. “EON 200%” would still support more traffic than the fixed-grid WDM approaches in a single fiber-pair network).

4.5.4.3.3. Number of candidate paths

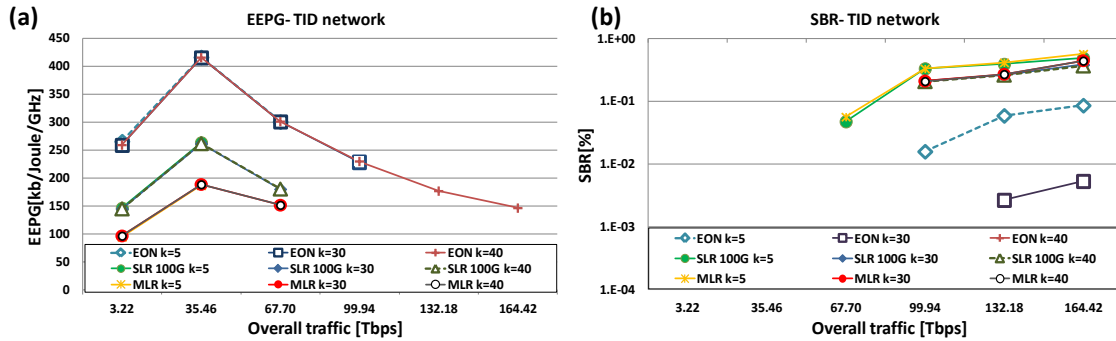

Figure 4.14. Parameter sensitivity analysis of the number of candidate paths (k in the KSP) in the TID network: (a) EEGP under non-blocking conditions; and (b) SBR.

In order to study the influence of the number of candidate paths (i.e. KSP), the k value was varied in a range between 5 and 40 for SLR 100G, MLR and EON architectures. In Figure 4.14a and Figure 4.14b, EEGP and SBR are shown for different k values, respectively. At low traffic, k has no significant influence on the results as the demands can be usually allocated in the first candidate paths because the spectrum occupancy is very low. However, as traffic increases, higher k values influence the SBR results since evaluating more alternative paths increases the chances of finding a feasible allocation solution. In fact, as shown in Figure 4.14b, higher values of k help in reducing SBR in certain circumstances. On the other hand, choosing very high k values also implies that the last calculated paths could become considerably long. Therefore, in many cases, increasing k significantly might not bring any improvement if the physical constraints cannot be fulfilled to achieve transparent transmission. As for the different network architectures, increasing k is more beneficial for EON as this architecture can take advantage of distance-adaptive modulation to reduce SBR. For instance, k equal to 40 can reduce blocking to zero in EON. On the other hand, using higher k also implies that significantly longer time is necessary to perform the simulations. In this work, a value of k equal to 30 was found to offer a good compromise between performance and complexity in terms of computational time. Regarding EEGP in Figure 4.14a, the obtained results are very similar and the slight differences at high traffic are explained by the different values of carried traffic (different SBR values also imply that different amounts of traffic are carried in the network).

4.5.4.3.4. Transmission reach

The influence of the transmission reach has been tested by modifying the associated transmission distances of WDM TSPs and the MFs of the BVT (i.e. increasing or decreasing the transmission reach is equivalent to proportionally decreasing or increasing the size of the network topology, respectively). The transmission distances have been modified in a range between 40 and 220 percent of the values presented in Section 4.4.3

The EEPG and SBR measures with the modified transmission distance values are presented in Figure 4.15a and Figure 4.15b, respectively. In particular, it can be noticed that EON is especially influenced by the transmission reach values (or the size of the network). Higher transmission reach values (e.g. “EON 220%” where the initial transmission distance is more than doubled with respect to the initial scenario- “EON 100%”) make it possible to use the most-efficient MF for almost any end-to-end transmission without being forced to employ robust ones (which are less energy- and spectral-efficient). Accordingly, EEPG values can be significantly improved as shown in Figure 4.15a. On the contrary, reducing transmission reach values (e.g. “EON 40%”) would certainly worsen the overall EEPG of the network. As for the fixed-grid WDM approaches, reducing the transmission reach would certainly reduce EEPG, as more traffic demands would be blocked. However, increasing the transmission distance does not show very significant differences in terms of EEPG. Firstly, SLR 100G do not permit to perform distance-adaptive modulation as there is only one LR available and so the TSPs would consume the same power. In case of the MLR, the *LRC*omb is selected according to the EEPG of the TSPs. Accordingly, increasing the transmission distance does not bring benefits in terms of EEPG. However, the number of allocated connections and thus the SBR could significantly vary depending on the transmission reach values.

In fact, Figure 4.15b shows that transmission reach has a considerable impact on SBR in all the evaluated network architectures (i.e. lower transmission reach imposes higher blocking due to physical constraints). It is worth mentioning that EON offers better performance in terms of SBR than fixed-grid WDM networks even if the associated transmission reach values of the modulation formats are reduced to 40 percent of the initial value (“EON 40%”). On the other hand, if the transmission distance is increased by 60 percent (“EON 160%”), no blocking was observed for the evaluated traffic conditions so that larger traffic volumes could be supported by the network. Regarding the other architectures, SLR 100G is the most affected by the transmission reach reduction (i.e. SBR is not zero even for an overall traffic equal to 3.22 Tbps if transmission reach is reduced to 40 percent- “SLR 100G 40%”) as more robust MF could not be selected to overcome the more restrictive physical constraints. MLR is also affected by the transmission distance reduction as shown in Figure 4.15b.

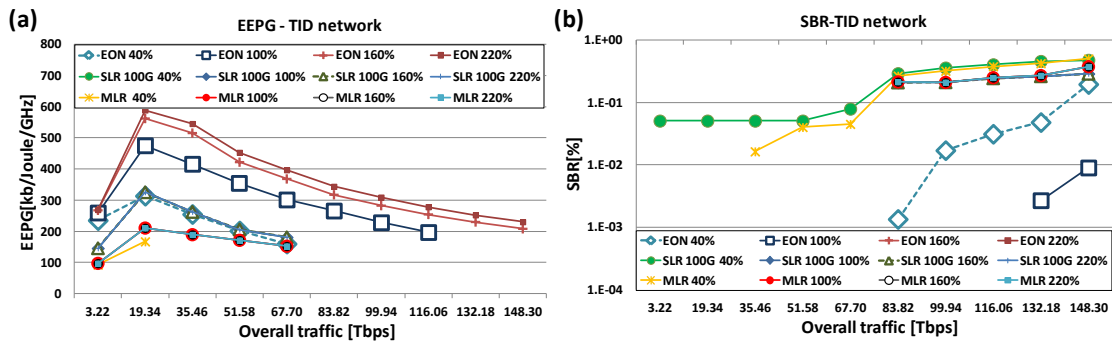

Figure 4.15. Parameter sensitivity analysis of the transmission reach of the different transmission technologies used in the TID network: (a) EEPG under non-blocking conditions; and (b) SBR.

4.5.4.3.5. Different metrics

The simulation results can also be affected by the metric that is used in the routing and resource allocation decisions. As mentioned in Section 4.5.3, the energy-aware heuristics algorithms employ EEPG metrics which have the objective of jointly optimizing the spectral and energy

efficiency. While the metric in SLR networks is not a key factor since there is only a single LR to choose, in MLR and EON it may play important roles when selecting the most appropriate transmission. In order to check the influence of the metric on the result, the algorithms were modified to consider metrics that take into account only PC or spectral occupancy (SO). For EON, no difference was found for the RMLSA as the three metrics always attempt to use the most efficient MF possible (that constrained by the physical reach), which is the optimum in terms of PC, SO and EEPG at the same time.

As shown in Figure 4.16a, the EEPG of MLR may change according to the optimization goal (determined by the chosen metric). As expected, setting EEPG as the optimization objective with an EEPG metric definitely provides the best performance in terms of EEPG. The SO metric provides similar performance to the EEPG. On the contrary, the metric based on PC in fact helps to reduce the overall PC of the network, but at the expense of using less spectral-efficient LRs. Accordingly, the spectral occupancy of the network is higher and eventually results in higher SBR, as shown in Figure 4.16b. Due to the aforementioned influence of the spectral efficiency in the overall energy efficiency of the network (i.e. more traffic can be conveyed in a single fiber), the EEPG metric was chosen for the different studies.

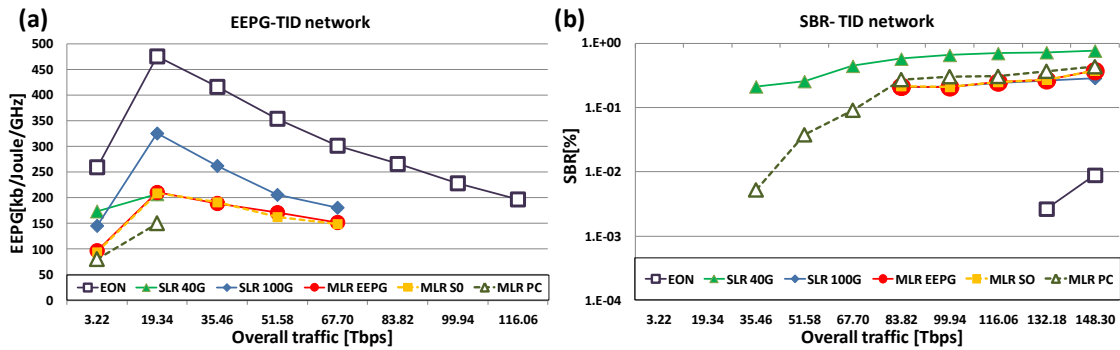

Figure 4.16. Parameter sensitivity analysis of different metrics used in the routing and resource allocation algorithms in the TID network: (a) EEPG under non-blocking conditions; and (b) SBR.

4.5.5. Conclusions

The significant traffic growth expected in the near future will require smarter ways of using the network and energy resources. One of the possibilities to achieve this target consists of moving from the rigid ITU-T channel spacing of 50 GHz to flexible-grid approaches. This would reduce the unused spectrum gaps in between the channels as well as provide more flexibility to transmit signals with different bandwidth. As shown in the results, adopting flexible-grid configuration significantly improves EEPG and reduces SBR even if fixed-rate WDM TSPs are used (i.e. SLR 40G, SLR 100G and MLR).

Moreover, a more efficient use of the spectrum can also be achieved by reducing the over-provisioning levels and exploiting the heterogeneous traffic requirements by the different line rates offered by MLR and EON. In particular, EON employs adaptive line rate TSPs (i.e. BVT) which provide a fine adjustment of the capacity to diverse traffic requirements. Even if the channel bandwidth is restricted to be multiples of 50 GHz (fixed-grid approach), EON offers superior results in terms of EEPG and SBR than any WDM approach.

Combining the flexible-grid operation with the adaptive line rate functionality of BVTs (i.e. EON) seems to be the most promising network architecture to improve the overall energy efficiency of the network, even if the BVTs are more energy-consuming than traditional WDM TSPs or even in topologies with larger dimensions. It has also been shown that selecting appropriately some parameters for the network design, such as the number of candidate paths (k parameter in KSP) or the routing metric may help in achieving a more energy-efficient network.

4.6. Energy efficiency of network operation modes

4.6.1. Motivation and scope

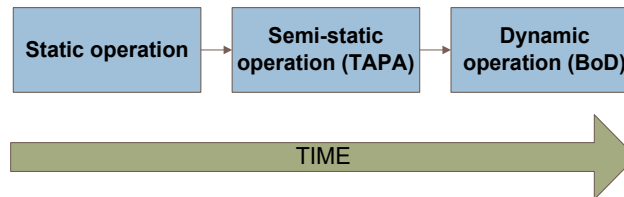

Figure 4.17. Evolution on the operation of optical transport networks: Static operation; Semi-static operation (TAPA); and dynamic operation.

Current optical transport networks operate in a static manner making the equipment employed in the optical layer to consume constant power independently of the actual traffic load. This section aims at evaluating novel operation modes in terms of energy efficiency: semi-static operation enabled by TAPA, and a fully dynamic or BoD approach. In fact, the TAPA approach can be seen as an intermediate step between the current static operation and the future BoD network (Figure 4.17). The analyses are carried out for different network architectures and under different network and traffic conditions.

4.6.2. Network parameters

4.6.2.1. Network architectures

The following network architectures and LRs have been evaluated:

- **WDM SLR over fixed-grid with fixed-rate TSPs:** A single type of TSP with a fixed LR (commonly based on the same technology) is used with the conventional ITU-T grid of 50 GHz. The considered LRs for this analysis are 40 and 100 Gbps
- **WDM MLR over fixed-grid with fixed-rate TSPs:** Line rates of 10, 40 and 100 Gbps can be transmitted in the same fiber with the ITU-T grid of 50 GHz. As explained in Section 4.5.2.1, a GB is included between the 10 Gbps and the 40/100 Gbps channels.
- **EON over flexible-grid with BVTs:** BVTs are used over a flexible-grid configuration with a FS of 12.5 GHz to fully exploit the benefits of the EON paradigm. Each “super-channel” has a bandwidth multiple of 12.5 GHz and a bilateral GB of 12.5 GHz is inserted to distinguish the different channels.

4.6.2.2. Network operation modes

The way in which the network operates also affects the overall energy efficiency of the network. For this reason, different operation strategies have been evaluated:

- **Static operation (evaluated in Section 4.5):** Traditional operation of optical transport networks. The spectral resources are permanently assigned according to the peak end-to-

end traffic demand, and the equipment used in the optical layer is assumed to always be turned-on and consume constant power.

- **Semi-static operation:** The spectral resources are assigned in a permanent manner (as in the static scenario), but the TSPs and OXCs could be partially deactivated or put into a sleep-mode state to save energy in a so-called TAPA operation.
- **Dynamic or BoD operation:** LPs are established and released on a demand basis (when requested by clients of the optical infrastructure). Thus, the network elements only consume energy when they are actually being used for data transmission.

4.6.2.3. Traffic conditions

4.6.2.3.1. Semi-static scenarios

In the semi-static scenario, the peak values from the TM (Section 4.5.2.3) are considered for dimensioning the network (i.e. the network must be able to cope with the traffic during the busy hour). Then, the traffic fluctuations can be exploited to temporarily turn-off some network elements such as TSPs and cross-connections at the OXCs during low-traffic periods (e.g. at night). The traffic fluctuations throughout working and weekend days are shown in Figure 4.18a and Figure 4.18b for the TID and DT networks, respectively.

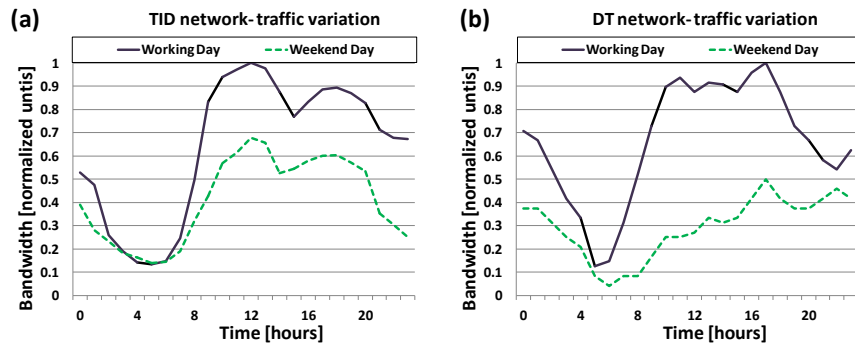

Figure 4.18. Traffic variation on working and weekend-days in 2012 for: (a) TID network model [101]; and (b) DT network (obtained from [104]).

4.6.2.3.2. Dynamic scenarios

Unlike the static scenario, where a traffic demand matrix with the fixed demands between node pairs is known prior to the provisioning of the resources, a connection between two nodes alternate ON and OFF periods in a dynamic scenario. In order to represent dynamic traffic, the demands are assumed to arrive in the network according to a Poisson distribution with a mean arrival rate λ (mean number of connection requests/time unit). The holding time follows an exponential distribution with intensity μ (mean number of finished connections/time unit). Then, different values of offered traffic (λ/μ) are considered to evaluate the performance at different traffic loads. The traffic matrix of the static scenario is used to specify which network nodes exchange information (source-destination pairs) and the maximum demand value between two nodes (the transmission rate is assumed to be a random value in the range between 1 and 100 percent of the peak value specified in the traffic matrix).

4.6.3. Methodology

The methodology to solve the routing and resource allocation problems is based on the heuristics for different operation modes. In this section, the steps carried out for the semi-static and dynamic operation are described.

4.6.3.1. Semi-static traffic-aware power-aware (TAPA) operation

Traffic-Aware and Power-Aware (TAPA) algorithm

1. Perform the routing and resource allocation according to the peak traffic demand and network architecture (Algorithm 1) and obtain performance measures including *TotalPC*
2. **for each** hourly traffic variation value during the day (0h-24h)
3. **for each** established LP
4. $currentTrafficDemand = trafficVariationFactor \cdot peakTrafficDemand$
5. Adapt transmission to *currentTrafficDemand* (according to the network architecture)
6. Compute energy savings with respect to *TotalPC* (check if possible to switch off some TSPs, or change MF in the BVTs in EON)
7. **end for**
8. **end for**
9. Calculate the daily average energy savings

Algorithm 5. Traffic-Aware Power-Aware (TAPA) algorithm for the semi-static scenario.

In the semi-static scenario, the routing and resource allocation are performed similarly to the static scenario, following the steps described in Algorithm 1 (i.e. considering the traffic demand matrix for peak traffic values to dimension the network). Once the performance measures from Algorithm 1 have been obtained, the TAPA algorithm presented in Algorithm 5 is executed.

As previously mentioned, TAPA considers that some network elements can be partially deactivated or turned-off to reduce PC during low-traffic periods. In fact, TAPA assumes that the transmissions can be adapted to the hourly traffic variations throughout the day (so that some TSPs could be switched-off for the PP when traffic is lower than the peak value). The update period is chosen to be one hour in order to find a reasonable compromise between the potential energy savings and the reconfiguration costs (i.e. modifying the transmission more frequently might not result in significant energy savings, but make the performance of the network more vulnerable and unstable).

Using the traffic variation information for working and weekend days in Figure 4.18, whether the established LPs can be adapted to the hourly traffic to reduce PC with respect to the “peak-traffic scenario” is evaluated. The routing part is not modified, whereas the resource allocation is re-computed according to the network architecture (WDM MLR, WDM SLR or EON). The overall energy savings are calculated at the end.

4.6.3.2. Dynamic operation

A connection between two nodes can alternate between ON and OFF periods. The routing and resource allocation for the different flows (time-varying traffic demands) are evaluated one-by-one in order of their arrival to the network. The time-varying demands are referred to as flows, whereas LPs refer to the all-optical paths that are established between network node pairs. An LP can transport one or several flows depending on its capacity (i.e. the number of allocated resources, either wavelengths or subcarriers). The algorithms may take into account the fluctuations in the transmission rate during the periods that the communication is active (i.e. grooming more than one flow with the same source and destination nodes onto the same LP) and the release of resources when the communication terminates (i.e. releasing the wavelengths or subcarriers used by the LP once the holding time of the connection expires). Accordingly, two types of events are considered:

- **Open connection request (new flow):** Once a traffic request is received, it is checked whether there is a previously established LP with the same source and destination nodes. In the affirmative case, the possibilities of either grooming the demand using the residual capacity of the LP, or expanding the LP are evaluated. The specific steps to perform grooming depend on the network architecture (i.e. additional subcarriers and/or modulation order increase can be evaluated for EON, whereas additional wavelengths can be assigned for the WDM cases). If grooming was not possible or there is no established LP with the same source and destination, the routing and resource allocation for a new traffic demand are evaluated similarly to the static scenario, i.e. according to the network architecture type (Section 4.5.3).
- **Close connection request (flow termination):** Connections may be closed if there is no need to continue transmitting data. When a flow terminates, whether there are more flows sharing the capacity of the LP is checked (i.e. this avoids having many connections alive with low traffic flows). If there is no other flow, the allocated resources can be released and the LP is fully terminated. Otherwise, it would be verified whether the termination of the flow allows for releasing some of the reserved spectral resources (i.e. wavelengths for WDM or subcarriers for EON). Additionally, in EON, it could be evaluated if the modulation order can be decreased to reduce PC. Once the holding time of the connection is reached, the energy consumption of the flow EC_{FLOW} (Eq. (15)) and the data transmitted $Data_{FLOW}$ in Eq. (16) are obtained. EC_{FLOW} is calculated by the product of PC_{TRANS} and the duration of the flow ($FDur$), while $Data_{FLOW}$ is obtained by multiplying the flow capacity $FCap$ and $FDur$.

$$EC_{FLOW}[Joules] = PC_{TRANS}[W] \cdot FDur[s] \quad (15)$$

$$Data_{FLOW}[bits] = Fcap[bps] \cdot FDur[s] \quad (16)$$

At the end of the simulated period, the final performance measures are calculated by taking into account the traffic and energy consumed since the moment when the network started to operate. The energy efficiency in the dynamic scenario (DEE) of the network is defined in Eq. (17) as the ratio between the total data transmitted ($TotalDataTr$), and the total energy consumed in the network ($TotalEC$) during the simulated time. $TotalEC$ is the summation of the energy consumption of the TSPs, the OAs and the OXCs. The contribution of the TSPs is obtained by the summation of the energy consumed by each of the flows in Eq. (15); whereas the ones related to the OAs (EC_{OA}) and OXCs (EC_{OXC}) are calculated considering the total energy consumed by these network elements in the total simulated time (assumed to be always ON). $TotalDataTr$ is calculated by summing the data successfully transmitted in every flow ($Data_{FLOW}$) in Eq. (16).

Moreover, the dynamic service blocking ratio (DSBR) is a critical measure in dynamic scenarios, as it determines the resources that the network requires to operate in acceptable conditions. $DSBR$ is calculated in Eq. (18) by the ratio between the summation of the data that were blocked ($\sum BlockedFCap$) and the summation of all the data requested to be transmitted during the simulated time ($\sum FCap$). As is the case in the beginning, when the network starts to operate, it is not in “steady state” (i.e. first flow requests are more likely to be successful than the last ones as the network is nearly empty), a first set of requests will be dropped from the calculation.

$$DEE[bits/Joules] = \frac{TotalDataTr[bits]}{TotalEC[Joules]} = \frac{\sum Data_{FLOW}}{\sum EC_{FLOW} + \sum (EC_{OXC} + EC_{OAs})} \quad (17)$$

$$DSBR[\text{percent}] = \frac{\Sigma \text{BlockedFCap}}{\Sigma \text{FCap}} \quad (18)$$

Each of the evaluated network architectures brings some particularities when dealing with dynamic traffic, especially in the processes by which the transmission rate of a connection is increased or decreased. These aspects are detailed in the following subsections.

4.6.3.2.1. EA-RWA for WDM single line rate network

Dynamic EA-RWA for WDM SLR algorithm: New flow request

1. **if** no existing source-destination LP
 2. Evaluate new LP establishment (Algorithm 2)
 3. **else**
 4. **if** new demand \leq residual LP capacity
 5. Grooming - Serve demand using the residual capacity of the LP
 6. **else**
 7. Evaluate allocation of additional wavelengths along the same LP
 8. **if** allocation possible
 9. Assign additional wavelengths in the path
 10. **else**
 11. Evaluate new LP establishment (Algorithm 2)
 12. **end if**
 13. **end if**
 14. **end if**
-

Algorithm 6. EA-RWA algorithm for WDM SLR in a dynamic Scenario: New flow request.

The basic operation carried out when a new flow request arrives is described in Algorithm 6. If there is an established LP with the same source and destination nodes, the new flow request can be seen as an increase on the transmission rate of an existing connection. Accordingly, the possibilities of either grooming the demand onto the residual capacity of the LP, or assigning additional wavelengths along the same path are checked first. Otherwise the establishment of a new LP is evaluated similarly to the process followed in the static scenario (Algorithm 2).

Regarding the flow termination, if there are no more flows sharing the LP, the allocated wavelengths are fully released and the connection is considered closed. Otherwise, it can be seen as a decrease on the transmission rate of an existing connection, so that it is checked whether the termination of the flow allows for releasing some wavelengths of the LP. In affirmative case, those extra wavelengths that are no longer necessary will be released, whereas the remaining ones will remain reserved for the LP. Moreover, the energy consumption EC_{Flow} and transmitted data $Data_{Flow}$ during the time period that the flow was active are calculated as in Eq. (15) and Eq. (16), respectively.

4.6.3.2.2. EA-RWA for WDM mixed line rate network

Algorithm 7 describes the steps followed by the EA-RWA in the dynamic scenario when a new flow request is received in the MLR architecture. The process is more complex than in the SLR case as more than one $LRComb$ could be feasible for a particular traffic demand.

First, if there is no established LP between the source and destination nodes, the establishment of a new one is evaluated. Otherwise, the possibility of grooming the demand onto the existing LP is first checked. If grooming is not possible, the necessary modifications in the resource allocation to serve the *new demand* (i.e. the summation of the new flow demand $FCap$ and the previous capacity carried by the LP) are evaluated. Thus, different $LRComb$ are calculated and sorted in descending order of $EEPGMetric$ at the TSP in $LRCombList$. Then, the first $LRComb$

from *LRCCombList* is compared with the *LRCComb* currently being used in the LP to determine the number of wavelengths to add or release in each of the wavebands.

Dynamic EA-RWA for WDM MLR algorithm: New flow request

```

1.  if no existing source-destination LP
2.      Evaluate new LP establishment (Algorithm 3)
3.  else
4.      if  $FCap \leq$  residual LP capacity
5.          Grooming - Serve demand using the residual capacity of the LP
6.      else
7.          Obtain current LRCComb of the LP
8.          List all the possible LRCComb for new demand according to the path length (reach of
          the highest line rate  $\geq$  path length)
9.          Sort the LRCComb in LRCComblist in descending order of TSP' EEPMetric
10.         while LRCComblist is not empty
11.             Calculate number of wavelengths to add in each band for LRCComb
12.             Calculate number of wavelengths to release in each band for LRCComb
13.             if (additional 10G necessary + additional 40G/100G necessary)==0
14.                 allocation possible
15.             else
16.                 if additional 10G necessary
17.                     Search for common wavelengths in the 1st band of the links
18.                     if allocation not possible
19.                         Search for common wavelengths by moving the GB to the right.
20.                     end if
21.                 end if
22.                 if additional 40G/100G necessary
23.                     Search for common wavelengths in the 2nd band of the links
24.                     if allocation not possible
25.                         Search for common wavelengths by moving the GB to the left.
26.                     end if
27.                 end if
28.             end if
29.             if allocation possible
30.                 if change wavelengths in second band necessary
31.                     Switch wavelengths in the second band (40G to 100G or vice-versa)
32.                 end if
33.                 if release wavelengths necessary
34.                     Release wavelengths
35.                 end if
36.                 if additional wavelengths necessary
37.                     Assign additional wavelengths
38.                 end if
39.             Break
40.         end if
41.     end while
42.     if allocation not possible with any LRCComb
43.         Evaluate new LP establishment (Algorithm 3)
44.     end if
45. end if
46. end if

```

Algorithm 7. EA-RWA algorithm for WDM MLR in a dynamic Scenario: New flow request.

Since the second band is shared by 40 and 100 Gbps transmissions, the wavelengths could be reassigned between these two LRs. If the total number of additional wavelengths in both bands is zero, the capacity of the LP can be upgraded (*allocation possible*) without the need to search for new available wavelengths (i.e. just by releasing the extra wavelengths and switching the wavelengths of the second band as necessary). However, if additional wavelengths are necessary, the WA procedure will be carried out to search for common available wavelengths in the links of the path. If a solution is reached, the corresponding modification on the WA will be applied. Otherwise, another *LRCComb* from *LRCCombList* is considered for WA. Finally, if the WA is not

successful with any of the *LRCOMB*, the establishment of a new LP (considering different routes as well) is evaluated similarly to the process carried out for the static scenario (Algorithm 3).

Regarding the flow termination, if there are no more flows sharing the LP, then the assigned wavelengths could be released. Otherwise, in a similar manner to Algorithm 7, new *LRCOMB* to serve *new demand* (equivalent to capacity of the LP minus *FCap*) are calculated and compared with the previous *LRCOMB* of the LP to determine the necessary modifications in the resource allocation to reduce PC (i.e. assigning and releasing wavelengths, and/or switching LRs in the second band).

4.6.3.2.3. EA-RMLSA for the OFDM-based elastic optical network

Dynamic EA-RMLSA for EON algorithm: New flow request

1. **if** no existing source-destination LP
 2. Evaluate new LP establishment (Algorithm 4)
 3. **else**
 4. **if** $FCap \leq \text{residual LP capacity}$
 5. Grooming- Serve demand using the residual capacity of the LP
 6. **else**
 7. Evaluate LP capacity upgrade: bandwidth expansion or modulation order increase based on the *EEPGMetric*
 8. **if possible capacity upgrade**
 9. Modify resource allocation for the most EEPG solution
 10. **else**
 11. Evaluate new LP establishment (Algorithm 4)
 12. **end if**
 13. **end if**
 14. **end if**
-

Algorithm 8. EA- RMLSA algorithm in a dynamic Scenario: New Flow request.

The description of the algorithm for a new flow request in a dynamic EON is presented in Algorithm 8. The process is similar to the one carried out for RWA algorithms. Thus, when a new flow request arrives and there is no active communication between the source and destination nodes (no existing LP), the establishment of a new LP is evaluated. Otherwise, different possibilities are checked to reuse the allocated resources considering firstly the possibility of grooming the new demand onto the existing LP. If grooming is not possible, an LP capacity upgrade is studied to expand the bandwidth and/or increasing the modulation order. The most efficient solution in terms of EEPG is selected if there are several possibilities (based on the *EEPGMetric*). Finally, if the capacity upgrade is not possible, the establishment of a new LP is evaluated according to Algorithm 4.

Similarly to the processes described for the other architectures, once a flow terminates (expiration of its holding time), it is checked which resources could be released. That is, if there are no more flows carried over the same LP, the allocated resources are released. Otherwise, it is verified whether a release of resources (reducing the number of subcarriers) or a decrease in the modulation order could be more advantageous in terms of EEPG.

4.6.4. Numerical results

4.6.4.1. Semi-static operation by traffic-aware power-aware (TAPA) approach

As mentioned, the resource allocation for the TAPA approach is realized in a similar manner to that of the static scenario (according to the peak traffic value). The difference lies in the different amount of energy that is consumed by the network.

In TAPA, the PC can be precisely adapted to the traffic variation by partially deactivating spare TSPs or adjusting the transmission rate of the BVT (only in the EON case). The hourly PC with the TAPA approach over a working day and a weekend-day are shown for the TID and the DT network topologies in Figure 4.19 and Figure 4.20, respectively. The results are presented for two overall traffic values to assess the influence of the traffic load on the performance of TAPA. As shown, when traffic increases, the PC varies more closely to the original traffic variations of the network (i.e. the ones shown in Figure 4.18). Among the different network architectures, EON demonstrates the best adaptability to traffic variations at any traffic load thanks to the adaptive line rate functionality (i.e. possible modification of the MF or release some of the subcarriers). The fixed-grid network architectures can also take advantage of the TAPA approach, and especially at high traffic load conditions (Figure 4.19b and Figure 4.20b). PC can be reduced significantly at off-peak hours (i.e. around 5 A.M. in both scenarios) with respect to the peak traffic situation, which occurs at 12 P.M. and 5 P.M. in the TID and DT networks, respectively.

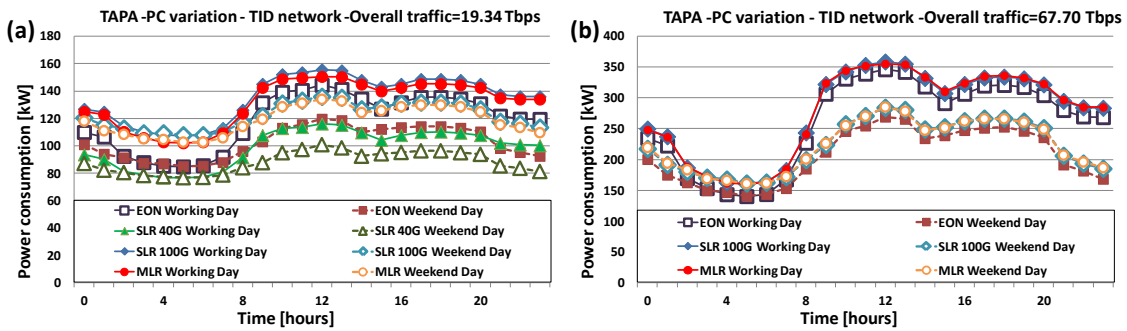

Figure 4.19. PC variation with the TAPA approach in the TID network for overall traffic values of: (a) 19.34 Tbps; and (b) 67.70 Tbps.

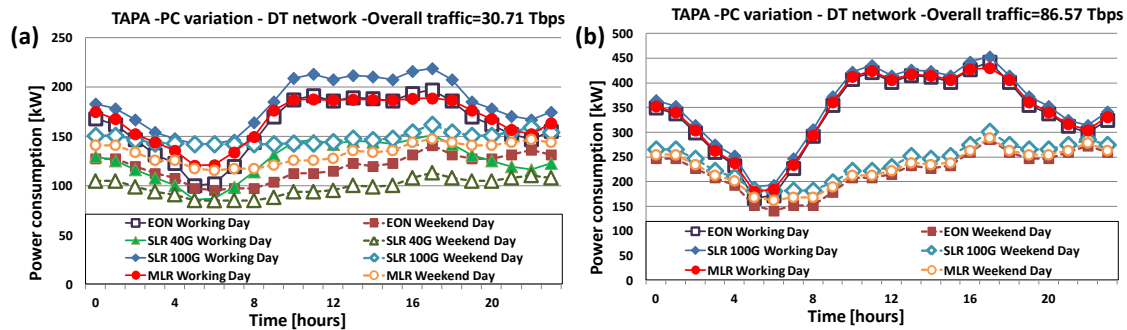

Figure 4.20. PC variation with the TAPA approach in the DT network for overall traffic values of: (a) 30.71 Tbps; and (b) 86.57 Tbps.

In Figure 4.21a and Figure 4.21b, the average daily energy savings that could be achieved on working days and weekends with TAPA compared to the conventional static scenario are presented for different network architectures and values of overall traffic for the TID and DT networks, respectively. In this regard, it can be concluded that TAPA can be especially beneficial

when overall traffic is high (i.e. energy savings of up to 45 and 53 percent are achieved in the TID and DT topologies, respectively). EON is the architecture which can take greater advantage of this scheme thanks to its great adaptability. Nevertheless, relevant power savings are also achieved for fixed-grid WDM networks. It is also worth mentioning that the TAPA approach is more beneficial on weekends, when the average traffic is much lower than the peak traffic (which occurs on working days as was shown in Figure 4.18).

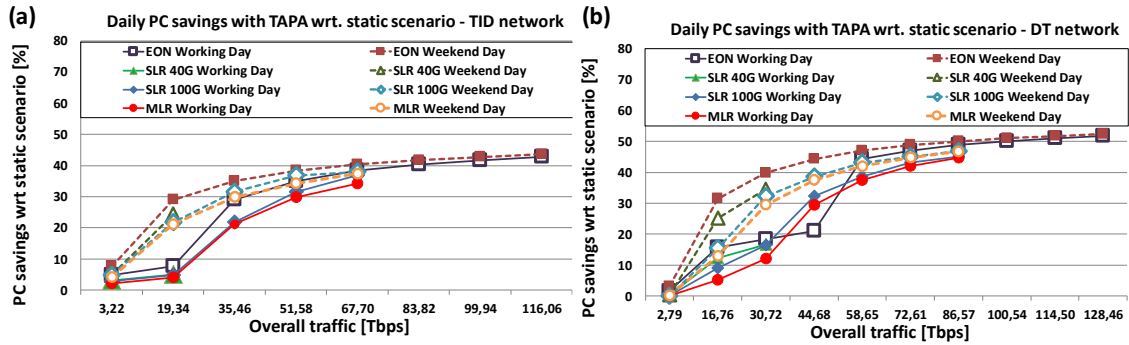

Figure 4.21. Average daily PC savings of TAPA compared to the static scenario in: (a) TID network; and (b) DT network.

4.6.4.2. Bandwidth on-demand services

Each simulation step (one for traffic load) considered 40,000 connection requests and that the system gets into steady-state after the first 4,000 requests. The average flow demand size was adjusted to 10 Gbps in order to make a fairer comparison among the different network architectures. Accordingly, considering this average traffic demand and offered traffic values (λ/μ) from 250 to 20250, the resulting traffic load values would vary between 2.5 and 202.5 Tbps approximately. In order to set the values of offered traffic, the arrival rate λ is varied, whereas μ is set to a fixed mean value of 1 time unit.

EON architectures over flexible-grid spectrum configuration and fixed-grid WDM networks are compared in terms of DEE (Figure 4.22) and DSBR (Figure 4.23) for both the TID and the DT network topologies. Despite the differences that the network topologies present (e.g. number of nodes, diameter, etc.), the results for both topologies lead to similar conclusions. EON clearly outperforms the WDM approaches regarding DEE (which is especially noticeable as traffic grows) thanks to its better adaptability to dynamic traffic changes. This is explained by the increased grooming possibilities at high traffic load (i.e. the number of simultaneous flows sharing source and destination nodes grows), which can be beneficial in both spectral and energy efficiency terms. In this regard, EON offers more alternatives for grooming the flows onto existing LPs than fixed-grid WDM networks thanks to the potential increase of bandwidth and/or modulation order. Nevertheless, WDM MLR also shows decent results in terms of DEE, which even get closer to the performance of EON.

As far as blocking is concerned, Figure 4.23 shows the DSBR values of the different network architectures. Indeed, the possibility of increasing the modulation order to enlarge the LP capacity results in reduced spectral occupancy, but the dynamic operation in EON may lead to spectrum fragmentation, which imply that new demands could not be allocated due to the lack of contiguous spectral resources. Spectrum defragmentation techniques (not implemented in this study) will help EON to reduce DSBR. Regarding the fixed-grid WDM networks, SLR 100G and MLR

are the ones showing the the most remarkable performance in terms of DSBR. Similar to the static scenario, MLR shows higher DSBR than SLR 100G due to the presence of a GB of 200 GHz which implies that part of the spectrum cannot be actually used for data transmission. SLR 40G is not a suitable solution for the evaluated traffic conditions as it presents considerably high DSBR values when traffic load increases (i.e. at high traffic loads, on average, almost 40 percent of the throughput requested in the flows is rejected due to the unavailability of spectral resources).

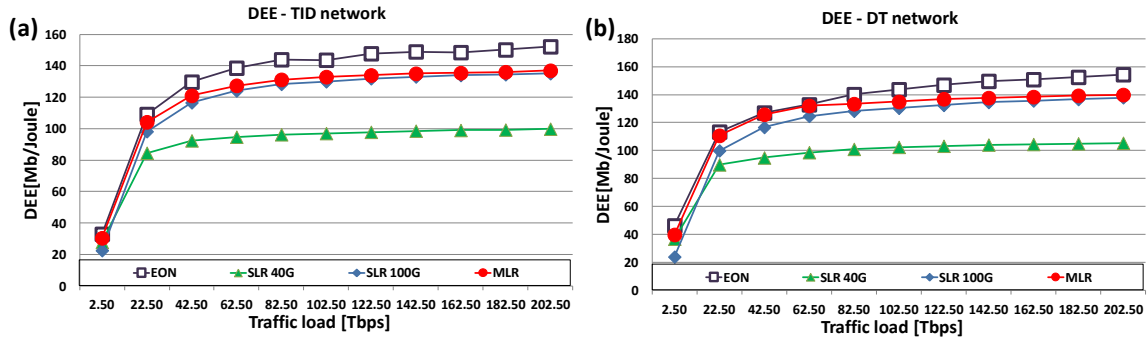

Figure 4.22. DEE in: (a) TID network; and (b) DT network.

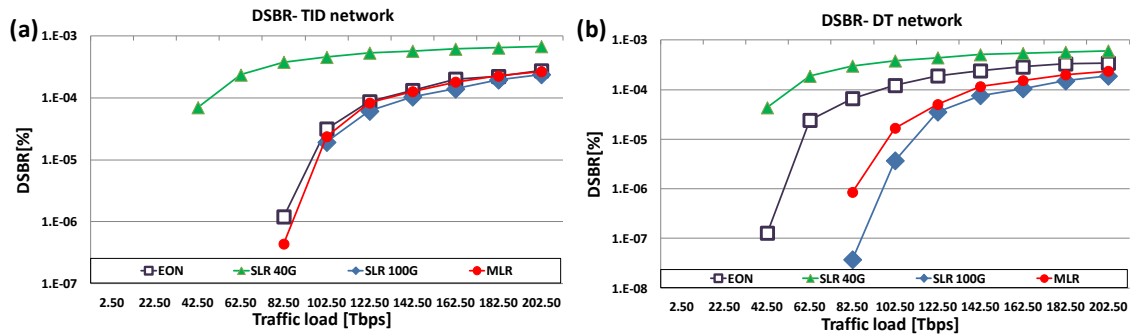

Figure 4.23. DSBR in: (a) TID network; and (b) DT network.

4.6.5. Conclusions

The inefficiencies caused by the static operation of current optical transport networks can be overcome by making the network more dynamic and adaptive to traffic changes. As an intermediate step towards dynamic networks, the TAPA approach showed that significant energy savings can be obtained by adapting the transmission or even deactivating them to follow traffic fluctuations. In fact, TAPA allows the networks to adapt their PC more proportionally to traffic load (especially at high traffic load conditions). EON can take especial advantage of the TAPA approach thanks to the great adaptability provided by the BVTs (bandwidth and MF can be adjusted).

A more disruptive approach considers a fully dynamic network where connections can be opened or closed on a demand basis. In this regard, EON again offers notably better performance in terms of energy efficiency and especially lower blocking (DSBR) than WDM approaches, which permits to convey higher traffic volumes per fiber.

4.7. Conclusions of the chapter

Internet traffic growth has imposed new requirements on the design of telecommunication networks. The core network will be essential to cope with the ever-increasing capacity demand of ICT services. Increased spectral efficiency has been one of the pursued objectives for a long time in order to facilitate the management and reduce cost. As of late, energy efficiency is becoming an increasingly important factor for the planning and design phases of networks, due not only to the economic implications (e.g. OpEx) but also when the ecological effects are considered (e.g. GHG emissions).

Until recently, the optical transport network was planned and operated in a rather rigid manner. The available spectrum was not efficiently utilized and the transmission was usually carried out by means of the same technology. Moreover, the resources were assigned in a quasi-permanent manner to support the peak traffic demand without considering the potential traffic fluctuations. Both issues may have an impact on the energy efficiency of the network. Currently, operators are considering to make significant changes in the transport network by adopting more flexible architectures and operation modes.

EON has been recently proposed as a promising network architecture to overcome the inefficiencies of the current fixed-grid WDM approaches. EONs rely on bandwidth-variable equipment over a flexible-grid configuration, which permit to finely match the capacity to the service demand (by adapting the MF and/or expanding/contracting the bandwidth).

EA routing and resource allocation algorithms for EON and fixed-grid WDM networks (SLR and MLR) have been developed and used to compare the performance of different network architectures and operation modes. The simulation results showed that EON can provide remarkable advantages in terms of EEPG with respect to fixed-grid WDM networks. These benefits were validated in two network topologies and for different traffic conditions, concluding that EON can be especially favorable to cope with the medium- and long-term traffic growths. Moreover, the EON architecture allows for transporting larger traffic volumes per fiber, which might be key to reduce PC as well (i.e. the deployment of additional network elements would not only entail a higher cost, but also an increase in energy consumption). The parameter sensitivity analyses also showed that the benefits in terms of EEPG provided by EON are fairly consistent even for higher PC values of BVT and different-sized networks. In fact, the advantages of EON are mainly enabled by the smart utilization of the network resources (enhanced spectral efficiency by reduced over provisioning levels and super-channel transmissions beyond 100 Gbps) as well as the great adaptability of EON to different conditions (distance-adaptive modulation). MLR architectures also showed generally improved performance in terms of energy efficiency with respect to SLR, but suffered from higher blocking than EON or SLR 100G at high traffic.

Nevertheless, the EON paradigm requires disruptive changes in the network to fully exploit its advantages (e.g. the installation of bandwidth variable equipment and changes in the frequency plans). Therefore, in the meantime, some intermediate solutions may also bring noticeable improvements in terms of EEPG. These approaches may include, for instance the utilization of MLR transmissions with conventional WDM TSPs over a flexible-grid, or the gradual migration to EON by deploying BVTs in some parts of the network keeping the 50 GHz ITU-T grid. In addition to the energy efficiency benefits, EON is expected to bring additional advantages given by the utilization of a single type of TSP in the network (e.g. economies of scale or reduced inventory of spare parts), software-defined TSP (e.g. simpler capacity upgrades by modifying MF by software

configuration), and BV-OXC (super-channels treated as single entity can decrease the port count in the OXC).

As far as operation modes are concerned, making the network more dynamic is expected to improve the utilization of network resources. The semi-static operation based on the TAPA scheme, which relies on the partial de-activation of the TSPs at low traffic periods, may bring energy savings even when keeping the current design of optical networks and architectures (i.e. network resources are still dimensioned according to the peak-traffic value and only the transmission is adjusted to the traffic variations). Indeed, savings can be achieved in both fixed-grid WDM and EON, but these can be more relevant in the latter due to its adaptive line rate functionality. Despite being a much more disruptive approach, adopting a fully dynamic operation of the optical layer, where connections are established and released on a demand basis (BoD services), is envisioned for future networks. This scenario has also been evaluated by energy-aware routing and resource allocation algorithms in fixed-grid WDM networks (with SLR and MLR) and EON. The simulation results showed the remarkable energy efficiency enhancements and reduced blocking enabled by the fine line rate adaptability of EON architectures. Nonetheless, it is worth mentioning that the implications of dynamic operation on the optical layer must be carefully assessed as to not significantly affect the performance and stability of the network (i.e. turning the equipment on and off might not be a completely “hitless” process).

To complete this chapter, an overview of the main findings is presented in Table 4.4.

Table 4.4. Overview of findings in Chapter 4.

Topic	Findings	Section
<i>Network architectures</i>		
Adaptive line rate vs. Fixed-rate	Data rate adaptation provides a fine matching of the capacity to the service demand, which allows the network to consume power more proportional to the actual traffic load.	4.5.4.1
Fixed-grid vs. Flexible-grid	Spectral efficiency improvements obtained by flexible-grid results in lower SBR and higher EEPG even when employing current fixed-rate WDM TSPs.	4.5.4.1/4.5.4.2
Fully flexible networks (based on flexible-grid and BVT) are more beneficial in terms of EEPG and permit to convey larger traffic volumes than fixed-grid WDM networks		
<i>Network operation mode</i>		
Energy-aware transmission adaptation	Adjusting the transmission and partially deactivating some TSPs during periods of low traffic result in significant energy savings. EON offers the largest reduction.	4.6.4.1
BoD services	BoD over the EON architecture is the most energy-efficient approach thanks to the line rate adaptability	4.6.4.2
The energy efficiency of the network can benefit from more dynamic operation modes and the adaptive line rate functionality of EON		
<i>Other findings</i>		
Traffic	More relevant energy savings in scenarios at high traffic loads.	4.5.4.3
Sensitivity to network size	EON shows great adaptability and can benefit from distance-adaptive modulation.	4.5.4.3
Sensitivity to PC of TSPs	EON can benefit from higher EEPG even if the BVTs consume significantly more power than fixed-rate WDM TSPs.	4.5.4.3
Sensitivity to network planning parameters	Parameters such as the number of candidate paths (KSP), or the metrics used may affect the overall performance of the network.	4.5.4.3

Future EON assuming flexible-grid will clearly enhance the flexibility of the network and provide enhanced energy and spectral efficiency with any network operation mode

CHAPTER 5. ENERGY-EFFICIENT RESILIENCE

An increasing number of indispensable services relies on the telecommunication infrastructure. Providing high service availability by guaranteeing high resilience against common failures is a must for operators. Common methods to protect networks are based on the provisioning of high levels of redundancy to make the network resilient to potential failures, which entails a consequent increase in energy consumption. This chapter evaluates the impact on energy efficiency of the currently deployed resilience schemes and proposes novel energy-aware protection schemes that could be applied to future networks.

5.1. Motivation

There is a special interest in investigating new mechanisms and technologies to improve the energy efficiency of future networks while maintaining the high reliability and service availability of current optical transport networks. Resilience (i.e. the ability of the network to provide and maintain an acceptable level of service in the face of different faults) is particularly important in the optical transport network as a single disruption due to, for instance a fiber cut, may cause huge data loss and affect the operation of a massive amount of services. As explained in Chapter 2, there are different methods to achieve resilience, which can be classified into two broad groups: Restoration (dynamic recovery performed after a failure has occurred) and protection (pre-planned failure recovery). As restoration is less reliable (i.e. recovery is computed “on-the-fly” so that it cannot be 100 percent guaranteed), and also takes longer time to recover from failures; protection is the common choice for operators.

Protection schemes can be further categorized in the way that protection resources are used. Dedicated schemes do not allow sharing of backup resources among multiple backup paths while shared schemes, under specific conditions, allow some PPs to use the same spectral resources. DP can be implemented in a 1+1 or a 1:1 fashion. In the former, the traffic is duplicated over two disjoint paths where one of the paths is selected by the destination node, whereas in the latter, the link-disjoint PP may carry traffic that can be pre-empted in case of a failure happening in the WP.

Operators are aware of the importance of network reliability. Hence, they commonly over-provision resources to reduce the risks of suffering data loss as much as possible (i.e. the disruption of particular services for even several minutes might have serious consequences).

Resilience is indeed an essential parameter when designing the network, but it is often neglected when evaluating the energy efficiency of optical transport networks and in the formulation of novel energy-aware methods, as discussed in [105]. This was in fact one of the motivations for comparing the energy efficiency performance of the most commonly used protection schemes (i.e. DP 1+1, DP 1:1, and SP schemes). The behaviors of these schemes were compared in different scenarios and conditions by taking into account that the assumed network architecture may strongly influence the energy efficiency of a particular network, as was demonstrated in Chapter 4. Accordingly, the performance in terms of energy and spectral efficiency of different protection schemes has been evaluated for the innovative flexible-grid EON and the conventional fixed-grid WDM networks with SLR and MLR.

Energy efficiency is indeed an increasingly relevant issue for operators, who are especially interested in approaches to reduce energy consumption. However, they are reluctant to adopt disruptive approaches that could sacrifice network reliability and affect the operation of the network. Therefore, though many efficient resilience schemes have been proposed thus far, DP 1+1 is currently the most widely deployed scheme as it can more securely fulfill most of the SLA terms (i.e. the data are obtained at the other end by two independent paths, and recovery can be achieved in less than 50 ms after a failure). Despite its high reliability, the simultaneous transmission on WP and PP requires the utilization of extra energy and spectral resources. This is obviously not the most energy-efficient solution, so novel energy-aware mechanisms that can maintain the reliability required by the end users are desired. This is in fact the main motivation for the work covered in this chapter. Accordingly, several proposals have been proposed and evaluated to address this challenge.

The first proposed approach attempts to improve the energy efficiency of the DP 1+1 scheme to maintain similar reliability levels with reduced PC. One of the inefficiencies of this scheme comes from the fact that resources are dimensioned for the peak-traffic demand on both WP and PP. Transmissions remain fully active without considering the traffic variations that may occur over time (i.e. the traffic demands at night are usually much smaller than those during the day). Traffic variations can be exploited by the DP Traffic-Aware and Power-Aware (DP TAPA) scheme. This mechanism considers line rate adaptation to real traffic in the transmission over the PP (i.e. unused resources can be put into sleep or turned off to save energy), while the transmission on the WP remains unaltered. In this manner, the normal operation of DP 1+1 is slightly modified. DP TAPA can be applied to different network architectures, so that the potential energy savings are evaluated for both fixed-grid WDM networks and flexible-grid EON.

Another aspect that can be exploited to enhance the energy efficiency of current optical transport networks is based on the coexistence of services with heterogeneous SLA requirements (i.e. throughput, delay, availability). Many services may not require the high level of reliability provided by DP 1+1, so that service guarantees can be differentiated and adapted to the specific traffic type. The heterogeneity of protection requirements requested by the clients could be exploited by a so-called differentiated quality of protection (Diff QoP) scheme to improve the energy and spectral efficiency of the network. Diff QoP provides the operator with a set of traffic classes differentiated by their reliability levels so that they can provision a service tailored to the customers' specific needs. This scheme can also be applied to the traditional fixed-grid WDM and flexible-grid or EON in different network and traffic scenarios.

5.2. Related work

Despite the overwhelming number of recent publications about green telecommunication networks, only a limited number of studies focus on energy efficiency in the context of network resilience. There are certainly many innovative approaches related to resilience with the aim of optimizing other parameters such as cost. However, reducing energy consumption has some additional implications and cannot be simply interchanged by cost. Firstly, energy efficiency is a trade-off against QoS. A cost minimization approach may save energy by shaping traffic over fewer routes, but on the other hand reduce the network reliability due to the potential impact that a failure may have when traffic volumes in some fiber are increased. Secondly, network devices implementing sophisticated energy saving functionalities could be initially more expensive than the conventional ones. Moreover, protection (and working path) routes may be designed to adapt the transmission to the instantaneous traffic demand, which reduce energy

consumption, but may not reduce or minimize the capital expenditures directly. Ye et al. identify the main challenges and trade-offs to consider in order to achieve an energy-efficient resilient network design in [105]. This work discusses the need for new techniques which specifically target energy-efficient resilience. In this section, an overview of these approaches is presented.

When it comes to network architectures, most of the published works study fixed-grid ITU-T WDM approaches. It is worth mentioning that the PPs may become significantly longer than the WPs, imposing additional constraints for high rate transmission when physical constraints are taken into account. For instance, the transmission with some specific LRs might be transparently feasible on the WP but require regeneration (or more robust MFs) on the PP. In this regard, EON can offer some additional advantage thanks to the distance-adaptive modulation possibility, which allows for using the same transponder for different transmission reaches, and eventually reducing the intermediate regenerations. Furthermore, the adoption of EON can introduce some novelties in the survivability mechanisms in optical transport networks. In particular, bandwidth elasticity can be exploited to reach a better utilization of the spectral resources by the application of, for instance, bandwidth squeezed restoration [17] and intelligent backup path sharing [18]. However, the potential benefits in energy efficiency of those techniques were not assessed in those works.

EA approaches focusing on resilience may come in place to reduce the power that is consumed with current protection schemes. Most of these strategies intend to save energy by concentrating backup paths in separate fibers, so that the devices on these links can be set into sleep-mode (low energy-consuming state) without being constrained by the presence of WPs, whereas survivable routing strategies tend to spread the routes among different resources. For instance, this idea has been exploited with DP in [67] and SP in [106] with energy savings of up to 25 and 40 percent, respectively.

Musumeci et al. compare dedicated link protection (DLP) and dedicated path protection (DPP) in [107], while they extend the analysis to shared link protection (SLP) and shared path protection (SPP) in [108]. The network design problems corresponding to the four protection strategies are formulated as ILP problems. Power savings of up to 20 percent can be achieved by enabling sleep-mode on the equipment used for protection purposes.

Jalalinia et al. propose an energy-aware shared path protection (EASPP) in [109] which tries to pack as much as possible primary paths in order to minimize PC, by encouraging both energy efficiency and the ability of sharing resources among PPs. The goal is to minimize both spectrum utilization and PC to address survivability and energy efficiency trade-offs. Two auxiliary graphs are used to calculate the primary and PPs. Finally, a tuning parameter is introduced to find a compromise between capacity and energy consumption.

In another work, Bao et al. propose a sleep-mode power-aware shared path protection heuristic algorithm in [110], which makes WPs and PPs to converge on different fibers as much as possible and puts idle protection components to sleep-mode to realize power savings. This strategy is applied in a dynamic scenario and then compared with a power-unaware SPP scheme (assigning WP and PP according to SPR with distances as weights). This scheme offers an attractive trade-off between power efficiency and blocking probability. Monti et al. also consider the possibility of applying sleep-mode to the protection resources when they are not being used in static WDM networks, which may provide significant energy savings as shown in [111]. Moreover, Jirattigalachote et al. evaluate a similar idea in [112] to quantify the energy savings that can be achieved when unused protection resources are set into sleep-mode and only activated when a

failure occurs. The authors claim that 25 percent of energy can be saved. In the previous work, several EA algorithms are also proposed to provision DP 1:1 services (using different weights in the KSP computation) in a dynamically operated optical network.

As for the concept of differentiating the traffic according to the reliability requirements, besides the Diff QoP scheme proposed in this chapter, another approach in a similar direction is evaluated by Muhammad et al. in [113]. This strategy is called Differentiate Reliability (DiR) and relies on adapting the reliability performance of a given protection scheme to the reliability requirements of the provisioned traffic. Thus, the PP does not need to be always available for any possible failure scenario for some traffic demands. That is, it would be possible to selectively assign protection resources only to those demands that really require them. This concept combines SP with sleep-mode to reduce energy consumption in up to 25 percent in a WDM network with dynamic operation.

Energy-efficient resilient design for translucent optical networks with RP in both static and dynamic scenarios is evaluated in [114-116]. More specifically, the authors study EA design with p-cycles and SP schemes regarding RP to satisfy the physical constraints. Two different stages are distinguished in the process: (1) LPs are set up using the SP and energy-efficient mixed RP, and then WA is performed based on the maximum transparent segment scheme; (2) Considers p-cycles which are assembled iteratively from high to low protection efficiency until all LPs are protected against any single-link failure. SP obtains the highest capacity and energy efficiency from both evaluated schemes.

5.3. General scope

In this chapter, different protection schemes are evaluated in terms of energy and spectral efficiency over several network architectures. More specifically, the goals are to assess: (1) Which of the commonly used protection schemes is more advantageous in terms of energy and spectral efficiency for the operation of optical transport networks; (2) How the energy consumed for resilience purposes can be reduced while fulfilling the SLA terms. In summary, the most important contributions of this chapter are:

- (i) Detailed explanation of the EA protection schemes for the design of both fixed- and flexible-grid optical transport networks.
- (ii) Comprehensive evaluation in terms of EEPG and network blocking ratios of the most common protection schemes: DP 1+1, DP 1:1, and SP.
- (iii) Evaluation of the potential energy savings of an innovative protection scheme, called DP TAPA, which exploits the daily traffic variations to save energy on the PP.
- (iv) Comprehensive study to validate the benefits of Diff QoP in terms of energy and spectral efficiency for different network architectures (i.e. ranging from static fixed-grid WDM with a single line rate to future dynamic EONs) and operation modes (static and bandwidth-on-demand) in a wide set of scenarios.

This chapter also includes a thorough description of the operation of different protection schemes, the network parameters and the scenarios considered in the investigation. Parts of the contributions of this chapter have been presented in the following publications:

1. J. López, Y. Ye, V. López, F. Jiménez, R. Duque, P. Krummrich, "On the Energy Efficiency of Survivable Optical Transport Networks with Flexible-grid," *European Conference and Exhibition on Optical Communications (ECOC)*, Sep. 2012.

2. J. López, Y. Ye, V. López, F. Jiménez, R. Duque, P. Krummrich, F. Musumeci, M. Tornatore, and A. Pattavina, "Traffic and Power-Aware Protection Scheme in Elastic Optical Networks," *XVth International Telecommunications Network Strategy and Planning Symposium (NETWORKS)*, pp.1,6, 15-18 Oct. 2012.
3. J. López Vizcaíno, Y. Ye, V. López, F. Jiménez, R. Duque, P. Krummrich, "Cost Evaluation for Flexible-Grid Optical Networks," *IEEE Global Telecommunications Conference (GLOBECOM) Workshops*, pp.358,363, Dec. 2012.
4. J. López Vizcaíno, Y. Ye, F. Jimenez, R. Duque, F. Musumeci, M. Tornatore, P.M. Krummrich, A. Pattavina, "Quality of protection schemes with extended flexibility for improved energy efficiency in transport networks," *9th International Conference on the Design of Reliable Communication Networks (DRCN) 2013*, vol., no., pp.28,35, Mar. 2013.
5. J. López Vizcaíno, Y. Ye, V. Lopez, F. Jimenez, R. Duque, F. Musumeci, A. Pattavina, and P. Krummrich, "Differentiated Quality of Protection to Improve Energy Efficiency of Survivable Optical Transport Networks," *Optical Fiber Communication Conference/National Fiber Optic Engineers Conference (OFC/NFOEC)*, pp. OM3A.1. Mar. 2013.
6. J. López Vizcaíno, P. Soto, Y. Ye, F. Jimenez, P. Krummrich, "Energy-efficient and Low Blocking Probability Differentiated Quality of Protection Scheme for Dynamic Elastic Optical Networks," *21st International Conference on Software, Telecommunications and Computer Networks (SoftCOM)*, pp.1,5, Sep. 2013.
7. J. López Vizcaíno, Y. Ye, F. Jiménez, P. Krummrich, "Energy- and Cost-Efficient Protection in Core Networks by a Differentiated Quality of Protection Scheme," *European Conference on Optical Communications (ECOC)*, Sep. 2013.
8. J. López Vizcaíno, Y. Ye, V. López, F. Jiménez, R. Duque, I. Tafur Monroy, Peter M. Krummrich, "Green Networking and Communications: ICT for Sustainability," *Chapter 17-Energy Efficiency Improvement with the Innovative Flexible-grid Optical Transport Network*, Auerbach Publications- CRC Press, Taylor & Francis Group, ISBN: 978-1-4665-6874-7, November 2013.
9. J. López Vizcaíno, Y. Ye, V. López, F. Jiménez, F. Musumeci, M. Tornatore, A. Pattavina, Peter M. Krummrich. "Protection in optical transport networks with fixed and flexible grid: Cost and energy efficiency evaluation," *Optical Switching and Networking*, vol. 11, Part A, pp 55-71, 2014.
10. J. López Vizcaíno, P. Soto, Y. Ye, P. M. Krummrich, "Differentiated quality of protection: An energy-and spectral-efficient resilience scheme for survivable static and dynamic optical transport networks with fixed-and flexible-grid," *Optical Switching and Networking*, vol. 19, Part 2, pp 78-96, 2016.

5.4. General network parameters

This section describes the main parameters used in the analyses in terms of energy efficiency of resilient networks. Many of these parameters are similar to those explained in Chapter 4 (Section 4.4).

5.4.1. Input and output parameters

The input and output parameters are the same as those presented in Table 4.1 (i.e. considering the desired type of protection scheme (DP, SP, DP TAPA, Diff QoP) for the network design).

5.4.2. Power consumption models

The PC models for OXCs, TSPs and OAs described in Section 4.4.2 are assumed for the following studies.

5.4.3. Physical layer constraints

The physical layer constraints are taken into account by comparing the maximum transmission distance of the TSPs (values presented in Section 4.4.3) with the path length. It is worth mentioning that the physical constraints may have an even more significant impact when protection is considered. This is due to the fact that longer routes are commonly selected as PPs to allow for route diversity, and thus the accumulation of physical impairments can be more significant.

5.4.4. Network topologies

The energy efficiency of the protection schemes has been evaluated in the network topologies explained in Section 4.4.4: TID and DT network topologies.

5.5. Energy efficiency of conventional protection schemes

5.5.1. Motivation and scope

Survivability to failures is a must for current optical transport networks. In the last few decades, novel protection schemes have been proposed to achieve better utilization of the spectral resources and make the network more resilient to failures. However, common protection schemes are still the options of choice for operators. Until recently, energy efficiency was not generally considered as an influencing parameter in deciding which protection scheme to use in the network design phase.

This section aims at evaluating common protection schemes from an energy and spectral efficiency point of view. Same as in Chapter 4, in order to jointly evaluate both parameters, an EEPG measure is employed to account for the number of useful data that can be transmitted per spectrum unit (GHz) with a Joule of energy. In the present study, end-to-end path protection against a single link failure is evaluated. More specifically, the following common protection schemes are evaluated:

- **DP:** Spectral resources are reserved along the working and protection (link- and intermediate node- disjoint) paths. DP schemes can be classified according to the strategy adopted for the transmission on the PP: DP 1+1 (Figure 2.17a) or DP 1:1 (Figure 2.17b). The former assumes simultaneous data transmission on both paths, while the transmission is carried out either on the WP or on the PP (in case of failure) at a given time in the latter.
- **SP** (Figure 2.17c and Figure 2.17d): The spectral resources which are not allocated for transmitting “working traffic” can be used for “protection traffic” in case of failure. SP is a pre-planned failure-dependent scheme (i.e. the PP is selected depending on the link which has failed), and failure localization is required which certainly increases the RT with respect to DP schemes (as explained in Section 2.3.6).

5.5.2. Network parameters

5.5.2.1. Network architectures

The following network architectures and LRs have been studied (as in Section 4.5.2.1):

- **WDM SLR with fixed-grid and fixed-rate TSPs of 40 and 100 Gbps.**
- **WDM MLR with fixed-grid and fixed-rate TSPs of 10, 40 and 100 Gbps:** A GB is included between the 10 Gbps and the 40/100 Gbps channels.
- **EON with flexible-grid and BVTs:** Each “super-channel” has a bandwidth multiple of 12.5 GHz (FS size) and a bilateral GB of 12.5 GHz is inserted between neighboring channels.

5.5.2.2. Network operation modes

The traditional static operation of optical transport networks is assumed in this study, where LRs are established to cope with peak traffic and remain fully active afterwards.

5.5.2.3. Traffic conditions

The traffic demand matrices in Section 4.5.2.3 are considered in this study, i.e. 48 bi-directional demands and a total traffic of 3.22 Tbps for the TID network, and 91 bi-directional demands summing up to 2.8 Tbps for the DT network.

5.5.3. Methodology

Several EA heuristic algorithms have been developed to solve the routing and resource allocation problems while taking protection into account. Similar to the methodology explained in Section 4.5.3, the algorithms employ an EEPG metric to select the most energy and spectral efficient route and the transmission format (*MF* or *LRCOMB*). As for the unprotected scenario, the operation of the algorithms differs according to the network architecture (WDM with SLR, WDM with MLR, or EON) and the chosen protection scheme, as described in the following subsections.

5.5.3.1. Static scenarios

Regarding the input and output parameters specified in Section 5.4.1, the objective is to determine the most convenient route and spectral allocation from source to destination nodes, so that the maximum amount of traffic can be served. Survivability is considered when evaluating a traffic demand for service provisioning, so that LPs have to be protected against, at least, any single link failure in the network (this being the dominating form of failure in optical networks). If the demand cannot be reliably provisioned (protected against any single link failure), it is considered to be blocked.

The routing and resource allocation are done in a similar way to that of the unprotected scenario by fulfilling the given constraints (e.g. physical constraint, wavelength continuity, etc.) and taking into account the particularities in terms of resource allocation of each network architecture (EON, WDM SLR and WDM SLR) explained in Section 4.5.3.

Concerning the performance measures, the SBR and EEPG of the network are as calculated in Eq. (5) and Eq. (6), respectively. The main difference when considering protection is that blocking (SBR) does not only account for the unavailability of resources on the WP, but also on the PP. In other words, if a traffic demand can be allocated in the network on its WP but not protected against any single link failure it is considered as blocked.

5.5.3.1.1. Algorithms for dedicated path protection (DP)

A basic description of the heuristics employed for the routing and resource allocation with *DP* is presented in Algorithm 9. The routing and resource allocation procedures are performed in a similar manner for the *DP* variants (i.e. *DP 1+1*, *DP 1:1*), but the computation of the PC differs according to the particular *DP* scheme.

The allocation is jointly evaluated for the possible combinations of candidate WPs (*KSP*) and their corresponding candidate PPs (*k*-link-disjoint paths) according to the network architecture (i.e. RWA for SLR, RWA for MLR, and RMLSA for EON), as explained in Section 4.5.3. For the potential combinations of WP and PP (i.e. the ones providing sufficient and common resources along the links of the path), a joint EEPG metric is calculated with the contributions of both paths.

EA-Algorithms for DP schemes (1+1, 1:1): Main flow

```

1. Sort the demands of the TM in descending order of demand value in ListOfDemands
2. DemandIndex  $\leftarrow$  1
3. while DemandIndex  $\leq$  size(ListOfDemands)
4.   Calculate KSP from source to destination and include them in ListOfWorkingPaths
5.   TotalHighestEEPGmetric  $\leftarrow$  0
6.   Initialize MostEfficientAllocation
7.   for each candidate path of ListOfWorkingPaths
8.     Calculate link-disjoint KSP from source to destination and include them in ListOfProtecPaths
9.     if ListOfProtecPaths is not empty (i.e. at least one link-disjoint path exists)
10.      Determine feasible LRs (WDM)/ MFs(EON) in the candidate WP (TX reach  $\geq$  path length)
11.      Calculate possible LRComb for TrafficDemand with the feasible LRs/MFs and sort them in
12.      descending order of TSP's EEPG in LRCombList
13.      HighestEEPGmetricWP  $\leftarrow$  0
14.      Initialize MostEfficientAllocationWP
15.      if LRCombList is not empty (i.e. transparent reach at least for one LRComb or MF)
16.        for each LRComb / MF
17.          Calculate number of required spectral resources (wavelengths or subcarriers)
18.          Search for common resources (Num. wavelengths in WDM or NoSubcPath in EON)
19.          if allocation possible in candidate WP
20.            Calculate EEPGMetricWP
21.            if (EEPGMetric > HighestEEPGmetricWP) or (HighestEEPGmetricWP == 0)
22.              HighestEEPGmetricWP  $\leftarrow$  EEPGMetricWP
23.              Save info in MostEfficientAllocationWP
24.            end if
25.          end if
26.        end for
27.        HighestEEPGmetricWP  $\neq$  0
28.        for each candidate path of ListOfProtecPaths
29.          Determine feasible LRs (WDM)/MF (EON) in the candidate PP (TX reach  $\geq$  path
30.          length)
31.          Calculate possible LRComb for TrafficDemand with the feasible LRs/MFs and sort
32.          them in descending order of TSP's EEPG in LRCombList
33.          HighestEEPGmetricPP  $\leftarrow$  0
34.          Initialize MostEfficientAllocationPP
35.          if LRCombList is not empty
36.            for each LRComb / MF
37.              Calculate number of required spectral resources (wavelengths or subcarriers)
38.              Search for common resources (Num. wavel. in WDM or NoSubcPath in EON)
39.              if allocation possible in candidate PP
40.                Calculate EEPGMetricPP
41.                TotalMetricEEPG = EEPGMetricWP + EEPGMetricPP
42.                if (TotalMetricEEPG > TotalHighestEEPGmetric) or (TotalHighestEEPGmetric == 0)
43.                  TotalHighestEEPGmetric  $\leftarrow$  TotalMetricEEPG
44.                  Save info in MostEfficientAllocation (including WP and PP info)
45.                end if
46.              end if
47.            end for
48.          end if
49.        end for
50.        HighestEEPGmetricWP  $\neq$  0
51.        if TotalHighestEEPGmetric  $\neq$  0
52.          Perform spectrum allocation in the WP and PP according to MostEfficientAllocation
53.        else
54.          Demand is blocked
55.        end if
56.        DemandIndex  $\leftarrow$  DemandIndex + 1
57.      end while
58.    if protection scheme is DP 1+1
59.      TotalPC  $\leftarrow$  PCTSPWP + PCTSPPP + PCOXCWP + PCOXCPP + PCOAS
60.    end if
61.    if protection scheme is DP 1:1
62.      TotalPC  $\leftarrow$  PCTSPWP + PCOXCWP + PCOAS
63.    end if
64.    Calculate performance measures (SBR, EEPG)

```

Algorithm 9. Main flow for the EA-Routing and Resource Allocation algorithms in a static scenario with DP.

This allows for the selection of the most energy- and spectral-efficient working-protection path combination and transmission parameters (e.g. *LRComb* in WDM or *MF* for EON) among the

feasible candidates. First the routing and resource allocation are evaluated for the WP by selecting the most efficient transmission possibility among the ones providing transparent reach ($LRComb$ in WDM network (only one for SLR and several for MLR) and MFs in EON) by an $EEPGMetricWP$ as in Eq. (2). The highest $EEPGMetric$ is saved in $HighestEEPGMetricWP$, while the information corresponding to the resource allocation (i.e. path, wavelengths, transmission information) is stored in $MostEfficientAllocationWP$. If the potential allocation in the evaluated WP is feasible, then the same steps are repeated to study the feasibility over the candidate paths for PP. In the end, another metric ($TotalMetricEEPG$) is obtained to account for the EEPG of both WP and PP. This enables the storing of the most efficient combination of WP and PP (that with the highest $TotalHighestEEPGMetric$) in the $MostEfficientAllocation$ variable, which also includes the information about the corresponding transmission format ($LRComb$ or MF).

Once a solution has been reached, the spectral resources are reserved for the WP and the PP and the appropriate logical cross-connections are configured at the OXCs. As mentioned earlier, if a WP and a PP cannot be provided for a particular traffic demand, then it is blocked as it cannot be reliably provisioned.

The computation of the total PC ($TotalPC$) differs for the different DP schemes types, as described at the end of Algorithm 9. For DP 1+1, the transmissions are simultaneous on both WP and PP, which implies nearly double energy consumption for reliably serving the demand (the OXCs and TSP of the PP consume energy). For DP 1:1, the transmission occurs only in one of the paths (protection transmission does not normally consume power). In summary, both DP 1:1 and DP 1+1 account for the PC of the devices in the WPs (i.e. OAs (PC_{OAs}), TSPs (PC_{TSPWP}) and OXCs (PC_{OXCWPP})), while DP 1+1 also includes the PC of the devices of the PP (i.e. TSPs (PC_{TSPPP}) and OXCs (PC_{OXCPP})). Finally, the performance measures such as EEPG and SBR are obtained based on Eq. (5) and Eq. (6), respectively.

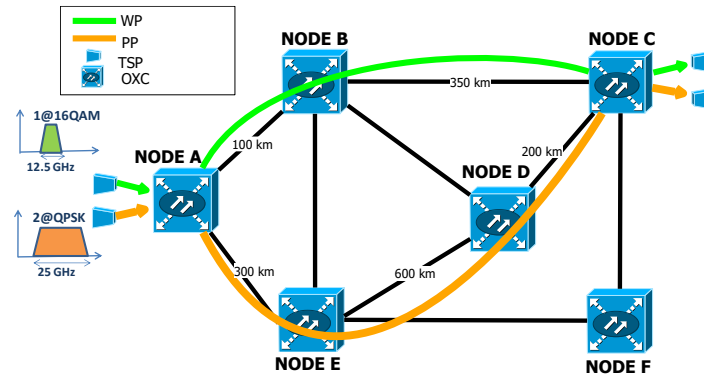

Figure 5.1. Example of WP and PP with different MFs in an EON architecture with DP 1+1 for a demand of 40 Gbps: (1) WP with 1x16QAM subcarrier over 450 km; and (2) PP with two 2xQPSK subcarrier over 1100 km.

Some particularities surface when designing the networks with different architectures. For SLR, DP always requires twice the spectral resources used for WPs, as well as the duplication of some energy-consuming devices such as TSPs in DP 1+1. However, in EON and MLR, there are several MFs and LRs to choose from with different PC values and spectral occupancy. Since PPs are commonly longer than WPs, it may happen that the transmission over the PP requires a different $MF/LRComb$ to achieve transparent reach. Thus, in some cases the spectral resources of the PP could be more than twice the number used for the working transmission in EON and MLR, as

depicted in the example of Figure 5.1 for EON (e.g. the PP requires a robust MF such as BPSK and thus more bandwidth than the WP that uses 16QAM).

5.5.3.1.2. Algorithms for shared path protection (SP)

EA-Algorithms for SP schemes: Main flow

1. Sort the demands of the TM in descending order of demand value in *ListOfDemands*
2. $DemandIndex \leftarrow 1$
3. **while** $DemandIndex \leq \text{size}(\text{ListOfDemands})$
4. Calculate KSP from source to destination and include them in *ListOfPaths*
5. $HighestEEPGmetric \leftarrow 0$
6. Initialize *MostEfficientAllocation*
7. Evaluation of LP establishment according to the network architecture (see Algorithm 2, Algorithm 3, Algorithm 4)
8. **if** *MostEfficientAllocation* exists
9. Establish LP for *MostEfficientAllocation* (path, resources IDs, LRCComb/MF)
10. **else**
11. Demand is blocked
12. **end if**
13. $DemandIndex \leftarrow DemandIndex + 1$
14. **end while**
15. **for each** *link of the network*
16. Fail link and list LPs traversing that link (SRG) in *SRGList*
17. De-allocate resources in those affected LPs in the *SRGList*
18. Prune failed link from the network graph
19. **for each** *affected LP of the SRGList* (sorted in descending order of demand value)
20. Evaluation of LP establishment according to the network architecture (see Algorithm 2, Algorithm 3, Algorithm 4) in the modified network graph
21. **if** *MostEfficientAllocation* exists
22. Save LP information in the list of possible PPs (path, resources IDs, LRCComb/MF)
23. **else**
24. Include demand in the *ListUnprotected* in the network (if not included before)
25. **end if**
26. **end for**
27. Restore original resource allocation state in the network (all links set as active)
28. **end for**
29. **if** *ListUnprotected* is not empty (i.e. no unprotected path)
30. Calculate SBR (total unprotected traffic/total traffic demand)
31. **end if**
32. $TotalLPC \leftarrow PC_{TSPWP} + PC_{OXCWP} + PC_{OAs}$
33. Calculate final measures (spectrum occupancy, EE, EEPG)

Algorithm 10. Main flow for the EA-Routing and Resource Allocation algorithms in a static scenario with SP.

As explained in Section 2.3.6., in SP, the protection resources are pre-computed and selected but not cross-connected (i.e. the intermediate nodes are not pre-configured to be used by any PP). SP is a failure-dependent protection scheme where multiple PPs are associated to each WP, which clearly contradicts DP schemes. Thus, several pre-computed PPs are provided for each LP and, in the case of failure, the selection of one PP or another depends on the particular link that has failed. The steps followed to provide SP are described in the pseudo-code of Algorithm 10. First, spectral resources are assigned to the WPs according to the network architecture as in the unprotected case (i.e. WDM SLR, WDM MLR, or EON) presented in the methodology of Section 4.5.3.

Then, once all the working traffic has been allocated, the remaining resources that were not used for working traffic can be shared and used to protect LPs. In order to check whether there would be enough available resources for the recovery of each LP, the failure of each link in the network is emulated consecutively. For each link failure, the shared risk group (SRG) -the LPs traversing the failed link- are listed in *SRGList*, and the routing and resource allocation procedures are performed again for the SRG in a modified network graph (i.e. a network in which the failed link has been pruned). If a new route can be provided for the affected LP, it is stored in a database

(list of PP); otherwise it is considered as blocked because it cannot be protected against failure of this link. *TotalPC* is calculated considering the power consumed by the network elements used for working traffic (i.e. protection does not consume any power).

5.5.4. Numerical results

The results in terms of *EEPG* for the different protection schemes (DP 1+1, DP 1:1 and SP) and network architectures (SLR 40G, SLR 100G, MLR and EON) are shown in Figure 5.2 and Figure 5.3 for the TID and DT networks, respectively. The obtained results for both network topologies lead to analogous conclusions. SP offers higher *EEPG* than the DP schemes at any traffic load; this is explained by the fact that the protection transmissions only consume energy and spectral resources in case of failure (at the expense of longer RT). Moreover, note that only the results under non-blocking conditions are shown in the figures (i.e. for those traffic values that allow all the traffic demands to be provisioned with the requested protection levels, in other words when SBR is equal to zero). In fact, the parameter SBR gives an indication of the total traffic that can be carried by a single-fiber network and may have an impact on energy consumption as well (i.e. more fibers would entail the deployment of additional energy-consuming devices).

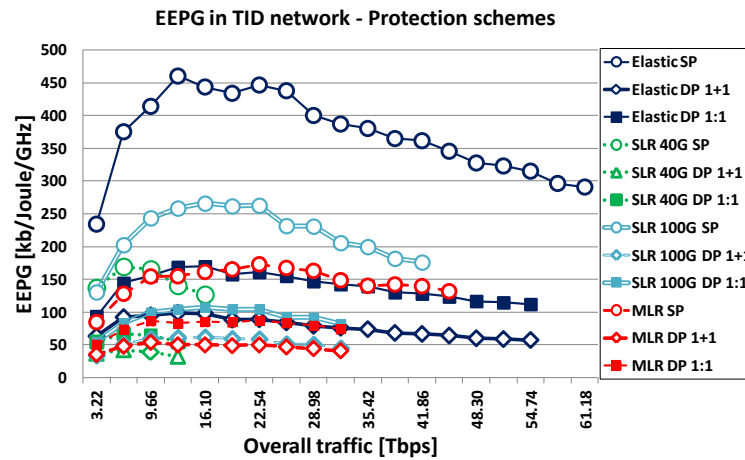

Figure 5.2. EEGP- Comparison of network architectures with different protection schemes in the TID network under non blocking conditions.

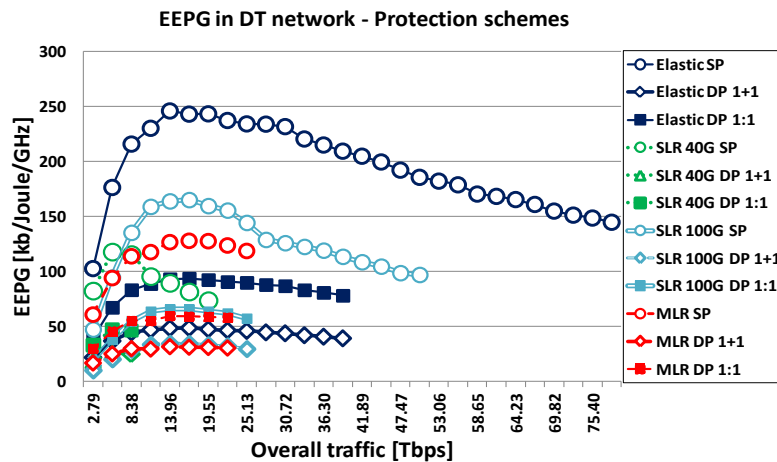

Figure 5.3. Comparison of network architectures with different protection schemes in the DT network under non blocking conditions.

The values of maximum traffic that can be carried with SP and DP schemes in the different network approaches are presented in Table 5.1 and Table 5.2 for the TID and DT networks, respectively. As can be noticed, the smarter utilization of resources of SP permits to convey more data per fiber than DP schemes. In fact, SP offers identical EEPG results to the unprotected case presented in Figure 4.5 since it does not require the provisioning of extra resources for protection purposes (i.e. protection resources are only used in case of failure). However, SBR is higher than in the unprotected case because in certain cases, the demands cannot be reliably provided with a potential PP even by sharing the protection spectral resources (e.g. in the TID network with EON, providing SP reduces the maximum traffic supported to 61.256 Tbps with respect to the 119.14 Tbps without protection).

As far as DP schemes are concerned, DP 1+1 shows the lowest EEPG as it requires duplicated transmission on WP and PP, which consequently increases the PC of the network. On the other hand, DP 1:1 is obviously more energy-efficient (because the PPs only consume energy in case of failure) but it is less reliable (i.e. longer RT as shown in Table 2.2).

Regarding the network architectures, the EEPG results are consistent with those obtained in the unprotected scenario (Section 4.5.4). EON is generally the architecture providing the best performance in terms of EEPG and SBR for any protection scheme. Indeed, EON improves its performance when traffic increases thanks to its better spectral efficiency (i.e. large traffic demands occupy considerably larger spectrum in fixed-grid WDM networks) and the smarter utilization of energy resources. Furthermore, its lower SBR enables it to transmit more traffic in a single fiber-pair per link network (see Table 5.1 and Table 5.2), which as mentioned before, also has an impact on energy efficiency. As for the fixed-grid WDM approaches, SLR 40G shows relevant EEPG at low traffic thanks to the lower energy per bit at the TSP (2.45 bits/Joule compared to 3.4, 3.51 and 9 for 10 Gbps in MLR, 100 Gbps and BPSK in the OFDM, respectively). However, as traffic increases, the spectrum occupancy of SLR 40G becomes considerably higher, thus resulting in very high SBR as well. Same as in the unprotected scenario, different stages can be observed in the EEPG performance of the different network architectures. EEPG generally rises with traffic up to a certain point where it starts to decrease due to the increased spectrum occupancy, and finally it results in some demands being blocked.

Regarding the network topologies, as shown in Table 5.1 and Table 5.2, the SP scheme presents higher SBR values in the TID network than in the DT network, it is explained by the geographical traffic distribution. In particular, there is high traffic density in the central region of this topology, which results in some links becoming very congested, and eventually avoids finding available spectral resources for protection when one of those links fails. However, the DP schemes offer lower SBR in the TID network due to the larger dimensions and bigger number of links, which increases the chances of finding a feasible link-disjoint PP (i.e. possible to evaluate the resource allocation in more k -shortest link-disjoint paths).

Table 5.1. TID network -Maximum traffic supported by the network architectures with DP and SP schemes.

Network Arch.	Max. Traffic with DP (Tbps)	Max. Traffic with SP (Tbps)
<i>EON</i>	54.74	61.18
<i>SLR 40G</i>	12.90	16.10
<i>SLR 100G</i>	32.24	41.89
<i>MLR</i>	32.24	45.13

Table 5.2. DT network -Maximum traffic supported by the network architectures with DP and SP schemes.

Network Arch.	Max. Traffic with DP (Tbps)	Max. Traffic with SP (Tbps)
<i>EON</i>	39.10	78.19
<i>SLR 40G</i>	8.38	19.55
<i>SLR 100G</i>	25.13	50.27
<i>MLR</i>	22.34	25.13

5.5.5. Conclusions

Common protection schemes are still the most widely implemented approaches to achieve resilience in optical transport networks. Among the protection schemes, SP was shown as the most energy- and spectral-efficient solution since protection can be provided at no extra energy or spectrum cost as long as there is no failure. DP 1+1, on the other hand, in spite of offering the highest availability and fastest recovery, is the least energy- and spectral-efficient scheme due to the simultaneous transmission on WP and PP. Moreover, DP schemes present higher SBR than SP schemes which also has an impact on the overall energy efficiency (i.e. deploying additional fibers and network elements not only imply an increase in cost, but also in PC). Migrating from DP to SP schemes results in significant improvements in energy efficiency, but the potential deterioration in terms of network reliability must be carefully assessed.

Regarding the comparison of different architectures, EON operating with a flexible-grid shows a remarkable superior performance over the fixed-grid WDM approaches regardless of the protection scheme, network topology and traffic conditions. EON is also the network architecture that offers the largest energy savings when moving from DP to SP schemes.

5.6. Energy efficiency with traffic-aware and power-aware scheme

5.6.1. Motivation and scope

In the previous section, the energy efficiency of different protection schemes was compared in different scenarios. From the results, it can be concluded that DP 1+1 consumes substantially more power and spectral resources compared to the case without protection and that a move towards more flexible schemes can help in reducing PC. In this regard, even though DP 1:1 and SP schemes commonly show better energy efficiency, they may sacrifice some reliability (e.g. longer RT) to achieve energy savings, which might not be accepted by most operators. For this reason, the DP 1+1 scheme continues to be the most widely used scheme due to its high reliability and short RT.

Saving energy while, at the same time, maintaining the required availability levels to fulfill the SLA terms motivates the research on novel energy-aware mechanisms. In this context, DP TAPA is proposed to reduce PC while providing a similar availability level as that of DP 1+1. In fact, DP TAPA is a variation of the DP 1+1 scheme which targets the reduction of the energy consumed by protection resources. The transmission on the WP remains fully active as long as there is no failure (i.e. operating for the peak traffic demand value), whereas the transmission on the PP is adjusted to the current required bandwidth requirements, thus permitting it to partially deactivate some TSPs or adapt the transmission when the traffic volume is low. The mechanism is depicted in Figure 5.4. As the WP remains unaltered, the stability and reliability measures of the network are not put into serious risk. Indeed, the capacity of the PPs will only be used whenever a failure occurs, guaranteeing that at such specific moment, enough throughput could be provided in the PP. An hour is considered as the update period for the transmission over the PPs (i.e. shorter time might make the network more unstable without significantly increasing the energy savings, while longer time might not be promising to achieve savings as traffic may considerably vary within a couple of hours).

A similar idea, TAPA, is proposed and evaluated to reduce PC in a semi-static scenario without protection (Section 4.6.4.1) by taking advantage of the fact that the overall load during off-peak hours (e.g. at night or in the early morning) is only a small percentage of the maximum value. In this section, the energy savings provided by DP TAPA with respect to DP 1+1 are evaluated for

several network architectures in different topologies and traffic scenarios (considering the realistic traffic variation that occurs during working days and weekends).

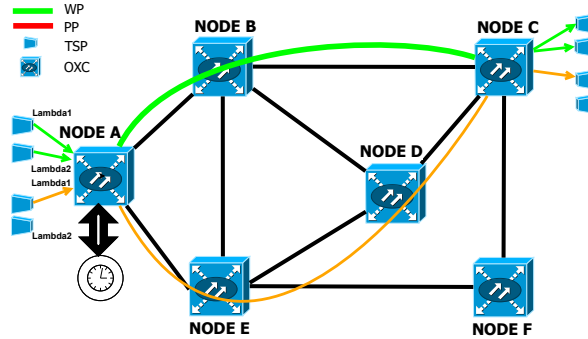

Figure 5.4. Example of DP TAPA operation: the PP is adjusted according to the information on hourly traffic variations and permits the deactivation of one TSP.

5.6.2. Network parameters

5.6.2.1. Network architectures

Fixed-and flexible-grid network architectures are considered (WDM SLR for 40 Gbps and 100 Gbps, WDM MLR 10/40/100 Gbps, and EON), as they may offer different adaptability to traffic variations. These architectures were described in detail in Section 4.5.2.1.

5.6.2.2. Network operation modes

The network resources are assigned in a static manner (dimensioned for peak-traffic values). However, while the operation on the WP is completely static, the one on the PP can be referred to as semi-static because it is adapted to the traffic variations every hour.

5.6.2.3. Traffic conditions

The peak values from the traffic matrix of the TID and DT networks are considered for dimensioning the network (Section 4.5.2.3). For the rate adaptation in the PPs, the traffic variations of Section 4.6.2.3.1 are assumed.

5.6.3. Methodology

DP- Traffic-Aware and Power-Aware (TAPA) algorithm: Main flow

1. Perform routing and resource allocation according to the peak traffic demand and network architecture with DP 1+1 (Algorithm 9) and obtain performance measures including *TotalPC*
 2. **for each** hourly traffic variation value during the day (0h-24h)
 3. **for each** protection LP
 4. $currentTrafficDemand = trafficVariationFactor \cdot peakTrafficDemand$
 5. Adapt transmission (according to the network architecture) to *currentTrafficDemand* in the PP
 6. Compute energy savings with respect to *TotalPC* (check if possible to switch-off some TSPs, or change MF in the BVT in EON)
 7. **end for**
 8. **end for**
 9. Calculate the daily average energy savings
-

Algorithm 11. DP TAPA algorithm.

The pseudo-code of DP TAPA is presented in Algorithm 11. First, the routing and resource allocation is performed considering DP 1+1 as the protection scheme and the network architecture (Algorithm 9). This procedure is repeated for all traffic demands and the total PC (*TotalPC*) is

obtained at the end. Following, the traffic adaptation in each of the established PPs is evaluated one-by-one, according to the hourly traffic variations, to check whether the transmission can be adapted to reduce PC (switching-off some WDM TSPs, and/or changing the MFs at the BVT in EON). This procedure is repeated for working and weekend days. Finally, the daily average energy savings can be calculated.

5.6.4. Numerical results

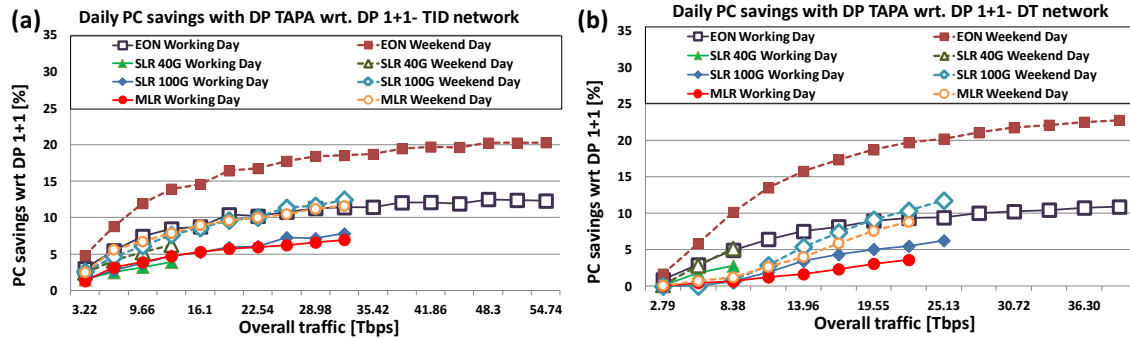

Figure 5.5. Daily energy consumption savings of DP TAPA with respect to DP 1+1 on working and weekend days for the different network architectures in: (a) TID network; and (b) DT network.

Figure 5.5a and Figure 5.5b present the average energy savings of DP TAPA with respect to the conventional DP 1+1 scheme that can be achieved per working and weekend days in the TID and DT networks, respectively. Note that in the figures, only the results under non-blocking conditions for DP 1+1 are shown, i.e. for SLR 40G in the DT network it is not possible to transmit more than 8.38 Tbps.

As shown in the results for TAPA in an unprotected scenario (Section 4.6.4.1), the energy savings are higher on weekends. This is explained by the average lower traffic load on these days, which enables the deactivation of the TSPs for longer periods. Energy savings are also more relevant at high traffic loads because the difference between the high and low traffic load conditions becomes more significant. In these conditions, a larger number of TSPs are frequently deployed per traffic demand. This increases the chances of switching-off some of them when traffic is reduced. Otherwise if the peak-traffic is significantly lower than the capacity of a TSP, many light-loaded TSPs have to be maintained active during off-peak hours to guarantee network resilience. In an SLR 100G network for example, for traffic demands smaller than 100 Gbps, no savings could be achieved even if traffic is reduced to 10 Gbps since the single TSP 100 Gbps used in the PP must remain active.

The potential savings are generally aligned for both evaluated network topologies, but the degree of savings may differ slightly depending on the selected architecture. EON, which is the architecture showing the highest EEPG with DP 1+1 (as shown in Figure 5.2 and Figure 5.3), can take advantage of the adoption of DP TAPA further. Its line rate adaptability given by the MF selection and the variable number of subcarriers permits it to achieve average energy savings above 20 percent on weekend days (i.e. 20.29 and 22.79 percent in the DT and TID networks, respectively). Nevertheless, significant savings can also be achieved for the fixed-grid WDM architectures when traffic grows, and especially for the SLR 100G which is one of the least energy-efficient approaches because of its frequent over-provisioning (e.g. a demand of 110 Gbps would require to deploy two WDM TSPs of 100 Gbps, so that a traffic reduction of more than 10 percent with respect to the peak traffic value, would permit one TSP to be deactivated).

5.6.5. Conclusions

Protection is traditionally accomplished by allocating dedicated resources in a 1+1 fashion. Protection resources are usually maintained active independently of the actual traffic requirements resulting in extra energy consumption. A novel protection scheme (DP TAPA) which exploits the traffic fluctuations throughout the day has been proposed to adapt the rate of the protection TSPs to the actual bandwidth requirements hourly. Meanwhile, the transmission over the WP remains active and operating to meet the peak traffic requirements. In this manner, the high availability of DP 1+1 can still be maintained. This scheme can provide energy efficiency enhancements with respect to DP 1+1 for both EON and fixed-grid WDM networks. Energy savings can be especially relevant in EON architectures and at high traffic load conditions (i.e. over 20 percent on weekend days).

5.7. Differentiated Quality of Protection scheme

5.7.1. Motivation and scope

As mentioned, the most commonly used method currently to ensure high resilience and availability is DP 1+1. Despite being the most secure and fastest known mechanism, it is obviously the least energy- and spectral-efficient protection scheme due to its high redundancy, as observed in the results presented in Section 5.5.

Operators are interested in solutions and mechanisms to enhance the energy efficiency of the network while maintaining the high availability levels to fulfill the SLA requirements. More flexible schemes can help overcoming some of the problems caused by DP 1+1 and thus improve the performance in terms of energy efficiency.

One of the inefficiencies comes from the fact that DP 1+1 is commonly applied to all traffic without distinction, even if it exceeds the protection requirements of some specific services/users. Matching the particular reliability requirements of each service or user is believed to improve the utilization of network resources for optical transport networks. This strategy is commonly referred to as differentiated quality of protection (Diff QoP) and was first introduced in [118-119] to reduce the blocking probability with respect to DP 1+1.

This section aims at evaluating the potential benefits of Diff QoP in terms of spectral and energy efficiency regarding different network architectures (fixed-WDM and EON), operation modes (static and dynamic traffic) and diverse traffic conditions. A comprehensive description of the algorithms used for designing a network with traffic differentiation in terms of protection requirements is also included.

The RT is one of the key parameters in the selection of the corresponding protection scheme. As mentioned in Section 2.3.6, each protection scheme provides different RT. A common practice of operators to guarantee the fulfillment of most SLA terms was to build their networks to provide the so-called 50 ms RT. However, this value (50 ms) is based on an historical specification of 1:N automated protection switching (APS) in a scenario where voice was the predominant traffic type (i.e. 20 ms for fault detection, 10 ms for signaling purposes, 10 ms for the operation of the tail-end transfer relay, and 10 ms as a time margin for any other possible delay) [120]. Nowadays, different applications/end users may need different levels of fault tolerance and also differ in the amount they are willing to pay for the service quality they receive. Hence, adapting the protection resources to the actual needs of the connection can provide an interesting trade-off between energy efficiency and protection. In order to implement this strategy in real deployment scenarios,

four different QoP traffic classes are defined to categorize the traffic according to the SLA terms. Each QoP traffic class is implemented by a different protection scheme and has an associated RT, as shown in Table 5.3 and previously explained in Section 2.3.6. The QoP traffic classes range from maximum protection (C1) to unprotected or best-effort services (C4). Furthermore, it is worth mentioning that C1 also provides additional reliability thanks to the duplicated TSP deployment (i.e. protection against TSP failure).

Table 5.3. Description of QoP traffic classes and associated RT.

<i>QoP Class</i>	<i>Protection scheme</i>	<i>Recovery time (RT)</i>
C1-Maximum Protection	<i>DP 1+1</i> , duplicated TSP(s)	<i>FD</i>
C2-High protection	<i>DP 1:1</i> , single TSP(s)	$FD+n \cdot PD+(n+1) \cdot MP+2 \cdot m \cdot PD+2 \cdot (m+1) \cdot MP$
C3-Medium protection	<i>SP</i> , single TSP(s)	$FD+n \cdot PD+(n+1) \cdot MP+2 \cdot m \cdot PD+2 \cdot (m+1) \cdot MP+(m+1) \cdot TO$
C4-Unprotected	Best-effort (<i>BE</i>), single TSP(s)	Not applicable (no traffic recovery is carried out at the optical layer)

5.7.2. Network parameters

5.7.2.1. Network architectures

Diff QoP has been evaluated in both fixed- and flexible-grid network architectures (WDM SLR for 40 Gbps and 100 Gbps, WDM MLR 10/40/100 Gbps, and EON). These architectures are described in Section 4.5.2.1.

5.7.2.2. Network operation modes

The following operation modes have been considered:

- **Static operation:** Traditional operation of optical transport networks, where the service provisioning is performed in a static or quasi-permanent fashion (i.e. once a LP is established, it may remain active for several years). Traffic is protected according to the requested protection requirements.
- **Dynamic or BoD operation:** Future optical networks are envisioned to account for the dynamic behavior of the traffic and cope with the instantaneous traffic load requirements. LPs are established and released on a demand basis according to the throughput and protection requirements of the customer.

The implementation of the Diff QoP scheme entails significant changes in the design of optical transport networks. Until recently, traffic has been commonly treated without applying any differentiation, e.g. LPs are commonly established to satisfy the end-to-end throughput requirements with the same protection scheme (commonly DP 1+1).

As an innovative deployment scenario, operators can target Diff QoP to offer optical virtual private networks (O-VPN) services to their corporate customers with different service quality levels (i.e. tailored to the customer's needs in terms of capacity and SLA). The connection request originated by the customers may include information about the source and destination nodes to be communicated, capacity, protection requirements (i.e. QoP traffic class), and duration (i.e. permanent or variable whether static or dynamic operation is assumed, respectively). These O-VPN services can be offered by means of transparent LPs between optical nodes.

5.7.2.3. Traffic conditions

Traffic is always one of the most influencing parameters for network design. As the potential advantages of Diff QoP with respect to DP 1+1 certainly depend on the traffic and the protection requirement of the customers, various traffic scenarios have been considered in this study; and both static and dynamic traffic conditions are considered.

5.7.2.3.1. Static scenario (offline)

The operator collects all the connection requests before starting the network planning phase and groups them according to the QoP traffic class. Then, the aggregated traffic demands at the optical layer are defined in a traffic matrix (TM) with the following format: $[C1, C2, C3, C4]$, where each component C_x defines end-to-end traffic demand of QoP class C_x for a particular node pair. The traffic information used in the static scenario of this study is slightly different from the previous studies where a reference TM was assumed as given. As a result, the traffic information is generated as follows:

1. **TM at aggregated level:** Firstly, the traffic demands are defined at an aggregated level (i.e. summation of the capacity requirements between node pairs independently of the traffic class) to guarantee a fair comparison in all the traffic scenarios. The overall traffic is initially set to 2 Tbps. Then, 50 percent of the overall traffic is uniformly distributed among all the possible source-destination demands; whereas the distance between node pairs is considered for randomly distributing the traffic for the remaining 50 percent (i.e. closer spaced nodes are assumed to exchange more traffic with each other). Moreover, the traffic has been assumed to be bidirectional in all traffic demands (i.e. same traffic demand between from node A to B as from B to A).
2. **TMs for different traffic scenarios (TS):** Five TS have been defined in Table 5.4 in descending order of availability requirements (i.e. percentage of traffic of C1 plus C2) to assess the potential advantages of Diff QoP in networks with different types of clients and protection requirements (e.g. the size or activity of the company may determine the resilience needed). For instance, TS1 represents a network scenario where large business customers requiring high service availability are predominant. On the other hand, TS5 emulates a scenario where most of the traffic belongs to small companies which do not require such high availability. In order to distribute the traffic into the different classes, the TM at the aggregated level and the percentages contained in Table 5.4 are employed (e.g. in TS1, 45 percent of the total traffic is randomly assigned with C1, etc.). Traffic bi-directionality is also maintained at this stage when assigning the QoP classes to the traffic demands.

Table 5.4 Description of Traffic Scenarios (TS) for the Diff QoP study.

Traffic Scenario	C1(percent)	C2(percent)	C3(percent)	C4(percent)
<i>DP 1+1</i>	100	0	0	0
<i>TS1</i>	45	35	10	10
<i>TS2</i>	35	25	20	20
<i>TS3</i>	20	20	35	25
<i>TS4</i>	10	10	45	35
<i>TS5</i>	5	5	50	40

3. **TMs for different traffic loads:** The performance of any approach is also strongly affected by the overall traffic in the network as shown in the previous studies. Accordingly, the

previously generated TMs for the different Traffic TSs and DP 1+1 (with overall traffic equal to 2 Tbps) are uniformly scaled up to 5, 10, 15 and 20 Tbps to evaluate the impact of traffic load on the results.

5.7.2.3.2. Dynamic scenario (online)

The dynamic scenario presents some significant differences with respect to the static one. In fact, the service provider does not receive the connection requests in advance, but rather “on-the-fly” while the network is operating. The clients can request to open/close a connection, or increase/decrease the throughput of an already established connection. This provides the operators with much more flexibility to exploit different strategies (e.g. the guaranteed throughput of some companies could be reduced at night to save energy).

As presented in the study performed for the dynamic scenario in Chapter 4 (Section 4.6), different traffic load conditions have been emulated by varying the offered traffic value (λ/μ), i.e. the arrival rate λ varies, whereas μ has a fixed mean value of 1 time unit. Diff QoP has been evaluated for offered traffic values from 250 to 2250 with average flow demand equal to 10 Gbps (resulting in approximate overall traffic loads in the range between 2.5 and 22.5 Tbps). The different TS of Table 5.4 are taken into account to assign which percentage of the requested traffic belongs to each QoP traffic class.

5.7.3. Methodology

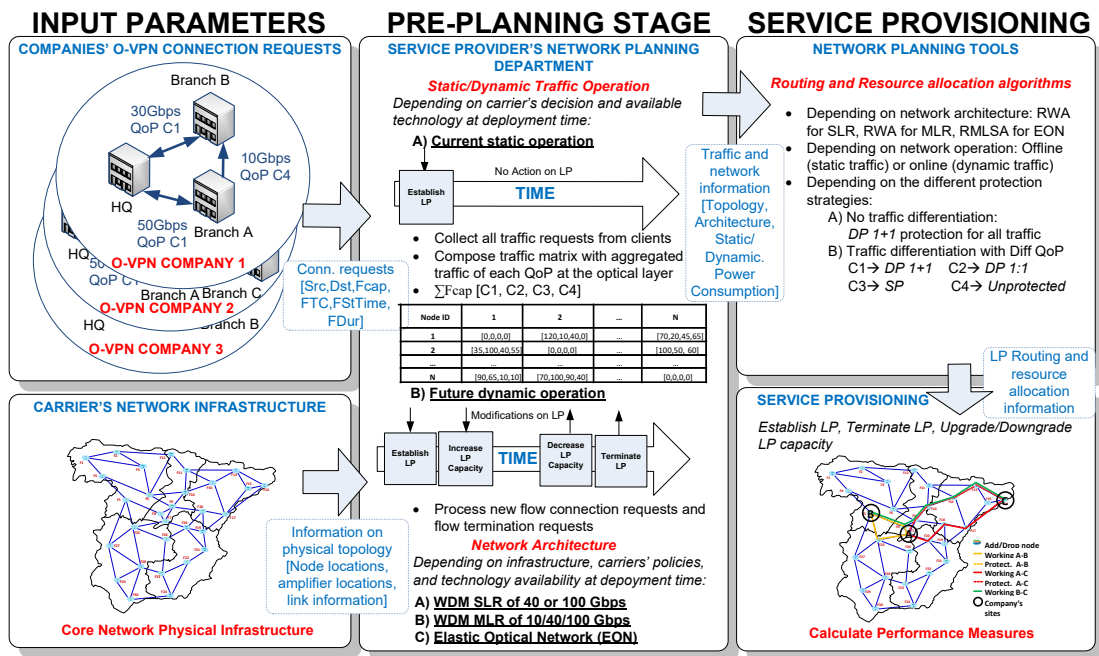

Figure 5.6. Framework for the implementation of Diff QoP in an optical transport network: Input parameters, pre-planning stage and service provisioning [121].

Figure 5.6 presents a framework with some of the main stages in the service provisioning with Diff QoP from an operator perspective. The same input and output parameters defined in Table 4.1 are used by the algorithms. In addition, the traffic demands now need to specify an additional field with the traffic class they belong to. Therefore, when the potential deployment scenario with O-VPN services are taken into account, a connection request can be characterized as follows:

[source node (*Src*), destination node (*Dst*), flow demand (*FCap*) in Gbps, flow QoP traffic class (FTC), flow duration (*FDur*), flow starting time (*FStTime*)].

The connection requests are processed in a different way whether static or dynamic operation is considered (i.e. whether the *FDur* field has an infinite or variable value). Once the connection requests are received, the network planning tools based on routing and resource allocation algorithms (according to the network architecture) are executed to determine the most convenient service provisioning option in terms of EEPG for the requested throughput and QoP (*FTC* identifies the traffic class and can take values from 1 to 4). The heuristic algorithms for the static and dynamic scenarios are described in the following sections.

In order to obtain a better utilization of the spectral and energy resources, traffic flows aimed at the same destination node can be groomed together onto the same LP provided that the protection requirements of each individual client can be satisfied (i.e. resources are already reserved and TSPs are active and consuming constant power). This can be done whenever the capacity assigned to LPs with higher QoP (lower *LPTC*) is not completely utilized. For instance, traffic requests of C4 (unprotected) could use the remaining unused capacity of an already established LP of C1 (DP). Note that traffic pre-emption has not been considered in this study.

5.7.3.1. Static scenario (offline)

Diff QoP algorithm for the Static Scenario: Main flow

1. Classify traffic demands in 4 TMs according to traffic class ($TMC=1$, $TMC=2$, $TMC=3$, $TMC=4$)
 2. $TMC \leftarrow 1$
 3. **while** $TMC \leq 4$
 4. Sort the *demands* of the TM in descending order of demand value in *ListOfDemands*
 5. $DemandIndex \leftarrow 1$
 6. **while** $DemandIndex \leq size(ListOfDemands)$
 7. **if** $TMC==1$ (i.e. QoP traffic class C1)
 8. Evaluate new LP establishment with DP 1+1 (Algorithm 9)
 9. **else**
 10. $Grooming \leftarrow 0$
 11. **if** *existing Src.-Dest. LP(s) with LPTC $\geq TMC$*
 12. **if** $FCap \leq residual\ LP\ Cap.$
 13. $Grooming \leftarrow 1$, i.e. serve demand using the residual capacity of the LP
 14. **else**
 15. **if** *network architecture is EON or MLR*
 16. **if** *possible grooming by changing MF or LRComb with same spectral resource*
 17. $Grooming \leftarrow 1$, i.e. serve demand modifying transmission accordingly
 18. **end if**
 19. **end if**
 20. **end if**
 21. **end if**
 22. **if** $Grooming==0$
 23. $HighestEEPGmetric \leftarrow 0$
 24. Initialize *MostEfficientAllocation*
 25. **Evaluate new LP establishment with corresponding protection scheme (Algorithm 9 for $TMC==2$, Algorithm 10 for $TMC==3$, Algorithm 2-4 for $TMC==4$)**
 26. **if** *MostEfficientAllocation* exists
 27. Establish LP for *MostEfficientAllocation* (resources IDs, path(s), LRComb/MF)
 28. **else**
 29. *Demand is blocked*
 30. **end if**
 31. **end if**
 32. **end if**
 33. $DemandIndex \leftarrow DemandIndex+1$
 34. **end while**
 35. $TMC \leftarrow TMC+1$
 36. **end while**
 37. Calculate performance measures (SBR, EEPG)
-

Algorithm 12. Diff QoP algorithm in the static scenario.

As mentioned earlier, the total aggregated traffic demands are known by the operator in advance and can be written in the form of a TM (the format is [C1, C2, C3, C4] in Gbps). Algorithm 12 presents the flow diagram of the implementation of Diff QoP in an offline scenario. The allocation of each QoP traffic class is realized according to its associated protection scheme, e.g. LPs of C1 are provided with DP 1+1. The routing and resource allocation with DP (C1 and C2) follow the steps in Algorithm 9, SP (C3) according to Algorithm 10 and the unprotected case (C4) being the same as in the algorithms of Section 4.5.3.1.

The traffic demands are served in descending order of protection requirements, i.e. according to the traffic matrix class (*TMC*). That is, first allocating all C1 traffic demands ($TMC=1$), followed by all C2 ($TMC=2$), C3 ($TMC=3$), and finally all C4 demands ($TMC=4$). This sequential evaluation allows for analyzing different traffic upgrading possibilities. Thus, traffic flows requiring lower protection could be upgraded to a higher QoP class and be provided with higher protection to achieve a smarter utilization of the network resources. Traffic upgrade will be evaluated for traffic flows belonging to C2, C3, and C4 (i.e. $TMC \geq 2$) to check whether they can be allocated using the remaining capacity of some established LP with the same source and destination nodes and higher QoP ($FTC \geq LPTC$). Note that if grooming is possible in more than one LP, priority is given to perform grooming on those with higher *TMC*. When grooming is not successful and the network architecture under consideration is EON or MLR, a change on the *MF* or *LRComb* is then respectively evaluated. This would permit increasing the capacity of the LP without assigning additional spectral resources (e.g. changing from BPSK to QPSK in EON or using a 100 Gbps TSP instead of a 40 Gbps one in MLR). Finally, if upgrading is not possible even by increasing the LP capacity (*Grooming* equal to zero), the routing and resource allocation are evaluated according to the corresponding network architecture and protection scheme to select the most energy- and spectral-efficient solution (by using the *EEPGMetric* of Eq. (2)). When the required protection requirements cannot be fulfilled for a traffic demand, then it is blocked.

Once the service provisioning for all the traffic connection requests is evaluated (i.e. all the demands contained in the traffic matrices), the following performance measures can be calculated:

- *Energy Efficiency Improvement (EEI)*: Calculated in Eq. (19) by the ratio between the *EE* of a network protected with a Diff QoP approach and with DP 1+1. *EE* is obtained in Eq. (7).

$$EEI[\text{percent}] = \left[\frac{EE \text{ with Diff QoP}}{EE \text{ with DP1+1}} - 1 \right] \cdot 100 \quad (19)$$

- *Spectral Efficiency Improvement (SEI)*: Calculated in Eq. (20), where *ASpE* is the average spectral efficiency considering all the links in the network ($TotalTrafficDemand/AvgSO$).

$$SEI[\text{percent}] = \left[\frac{ASpE \text{ with Diff QoP}}{ASpE \text{ with DP1+1}} - 1 \right] \cdot 100 \quad (20)$$

- *Service blocking ratio (SBR)*: Ratio of the transmission rate of the demands blocked and the total traffic demand as defined in Eq. (5).

5.7.3.2. Dynamic scenario (online)

Similarly to the unprotected dynamic scenario described in Section 4.6.3.2, algorithms have to respond to the two following events: new flow requests and flow termination.

5.7.3.2.1. New flow request

Algorithm 13 presents the operation of the heuristic algorithms whenever a new flow request is received in the network. Same as in the unprotected dynamic scenario, the request is treated differently depending on whether there is an already established LP between the same source and destination nodes. However, in this case, the protection level also has to be taken into

account for evaluating grooming possibilities, i.e. whether the QoP class ID of the flow request (*FTC*) is greater or equal to the QoP class ID of the LP (*LPTC*):

Diff QoP algorithm for the Dynamic Scenario: New flow request

1. *Grooming* $\leftarrow 0$
2. **if** existing *Src.-Dest. LP* with $LPTC \geq TMC$
3. Sort candidate LPs for grooming in descending order of *LPTC* in *LPGroomingList*
4. *LpCandIndex* $\leftarrow 1$
5. **while** $LpCandIndex \leq \text{size}(LPGroomingList)$ and *Grooming* == 0
6. **if** $Fcap \leq \text{residual LP capacity}$
7. *Grooming* $\leftarrow 1$, i.e. serve demand using the residual capacity of the LP
8. **else**
9. **if** network architecture is *EON* or *MLR*
10. **if** possible grooming by changing *MF* or *LRComb* with same spectral resources
11. *Grooming* $\leftarrow 1$, i.e. serve demand modifying transmission accordingly
12. **end if**
13. **end if**
14. **if** *Grooming* == 0 and $TMC \neq 1$
15. **if** possible bandwidth expansion assigning additional wavelengths/subcarriers
16. *Grooming* $\leftarrow 1$, i.e. serve demand modifying transmission and allocation
17. **end if**
18. **end if**
19. **end if**
20. *LpCandIndex* $\leftarrow LpCandIndex + 1$
21. **end while**
22. **end if**
23. **if** *Grooming* == 0
24. *HighestEEPGmetric* $\leftarrow 0$
25. Initialize *MostEfficientAllocation*
26. **Evaluate new LP establishment with corresponding scheme (Algorithm 9 for $TMC==2$, Algorithm 10 for $TMC==3$, Algorithm 2-4 for $TMC==4$)**
27. **if** *MostEfficientAllocation* exists
28. Establish LP for *MostEfficientAllocation* (resources IDs, path(s), *LRComb/MF*)
29. **else**
30. Demand is blocked
31. **end if**
32. **end if**

Algorithm 13. Diff QoP algorithm in the dynamic scenario: New flow request.

a) **Increase connection throughput:** New flow request with active communication between source and destination nodes (existing LP)

This possibility is evaluated first whenever there is an already established LP with the same *Src* and *Dst* of the new traffic flow request and provided that the LP is able to meet the protection requirements (i.e. $FTC \geq LPTC$). This can be seen as a request to increase the throughput of a particular connection. For instance, a C3 flow could be transported using the remaining capacity of a C1 or C2 LP. The following options are analyzed with the specified order of priority to reuse the remaining capacity of the established LPs:

- 1st priority- Groom flow on LP without *MF/LRComb* change –*SLR, MLR* and *EON*
This is the traditional grooming process, consisting of transporting the new flow onto an existing LP without modifying any transmission parameter (i.e. *MF/LRComb*). Grooming can be applied if the flow capacity is lower than or equal to the residual capacity of the existing LP ($Fcap \leq \text{Residual LPCap}$). This is the preferred option as it allows for transporting more traffic in the network without allocating additional spectral resources or consuming extra energy (i.e. no need to turn-on more TSPs nor allocate new spectral resources). Grooming can be realized in any network architecture provided that the SLA terms are fulfilled ($FTC \geq LPTC$). In addition, it is worth mentioning that if there is more than one valid candidate LP for grooming in the *LPGroomingList*, they are sorted in

descending order of QoP traffic class ID (from $LPTC=4$ to $LPTC=1$). Thus, the remaining capacity of LPs with lower QoP is filled first, while the resources of LP with higher QoP (e.g. $LPTC=1$) can be kept available for future flows requiring high availability levels.

- *2nd priority- Groom flow on LP with MF or LRComb change - EON and MLR*
Enhancing the capacity of the LP ($LPCap$) by changing the MF or $LRComb$ (without allocating additional resources) can be realized in EON or MLR, respectively. In SLR, it is not possible due to the presence of only one LR which cannot be changed. As in the previous case, if several LPs are available in $LPGroomingList$, the $MF/LRComb$ will be first evaluated on the LP of the same QoP class ($FTC=LPTC$), and then for those LPs with different QoP class ID ($FTC>LPTC$). Further, a constraint has been set not to allow for a modulation order increase in LPs of C1 ($LPTC=1$) for flows belonging to different QoP classes, as otherwise the amount of PC increase will be doubled with DP 1+1 (MF or $LRComb$ would be changed on both WP and PP).
- *3rd priority- Bandwidth expansion of LP with/without MF or LRComb change – SLR, MLR, and EON (SLR does not allow for MF changes)*
When the two previous possibilities are not successful, a bandwidth expansion can be evaluated to expand $LPCap$, i.e. allocating additional wavelengths or subcarriers along the already established LP. This may be more convenient than establishing a completely new LP as it allows for reusing the remaining capacity of an existing LP. The bandwidth expansion can only be carried out in LPs with the same QoP traffic class ID as the flow. The bandwidth expansion can also be complemented by a $MF/LRComb$ change in EON and MLR to further enlarge the capacity, respectively.

Finally, if none of the three previous options are feasible (*Grooming* is zero), the establishment of a new LP (“open connection request”) will be evaluated.

b) Open connection request (new flow):

If there is no active communication between *Src.* and *Dst.* nodes or the previous possibilities to reuse the capacity of existing LPs failed, the establishment of a new LP will be evaluated. The LP establishment is carried out in a similar way to that of the static scenario (Algorithm 9 and Algorithm 10), i.e. depending on the network architecture, and the protection scheme dictated by the QoP traffic class. For the LPs requiring DP (C1 and C2), WP and PP must be provided for the connection. On the other hand, for those flows needing SP (C3), a set of spectral resources are reserved in the links (which can be shared by different LPs) which can be used to recover any connection with SP. The required spectral resources are assigned to its WP, and a set of possible PPs are pre-planned offline (protection against single-link failure). In order to do so, the failure of each link in the WP is sequentially emulated to check whether a possible PP can be provided for that LP (in a modified network graph where the failing link has been pruned). If a WP and all the necessary PPs can be provided for a demand, the WP is established and the possible protection routes are stored in a database. If the allocation with the required protection cannot be realized, then the flow request is blocked because it cannot be protected against all single link failures.

5.7.3.2.2. Flow termination

The procedure described in Section 4.6.3.2 is followed when a flow terminates. As explained, the set of actions to execute differ according to whether the LP carries one or several flows. For instance, if a single flow is being transported by the LP, the connection is closed and all the allocated spectral resources released. Otherwise, the termination of the flow can be seen as a decrease of the connection throughput, which means that the communication between the node

pair will continue being active. However, whether part of the reserved spectral resources can be released or the *MF/LRComb* can be changed is evaluated for EON and MLR, respectively. The main difference with respect to the unprotected scenario lies in the fact that the process must be repeated on both WP and PP for flows with DP (i.e. *FTC* equal to 1 or 2).

Once the number of events to be simulated is reached, the performance measures are obtained and compared with those of a network implementing DP 1+1.

- *Dynamic Energy Efficiency Improvement (DEEI)*: Calculated by the ratio between the DEE (17) with Diff QoP and DEE with DP 1+1 as in Eq. (21).

$$DEEI[\text{percent}] = \left[\frac{\sum DEE \text{ with Diff QoP}}{\sum DEE \text{ with DP1+1}} - 1 \right] \cdot 100 \quad (21)$$

- *Dynamic Service Blocking Ratio (DSBR)*: Calculated in Eq. (18), reflecting the traffic that could not be allocated in the network due to the unavailability of resources to provision services with the required protection levels.

5.7.4. Numerical results

5.7.4.1. Static scenario

5.7.4.1.1. Energy efficiency

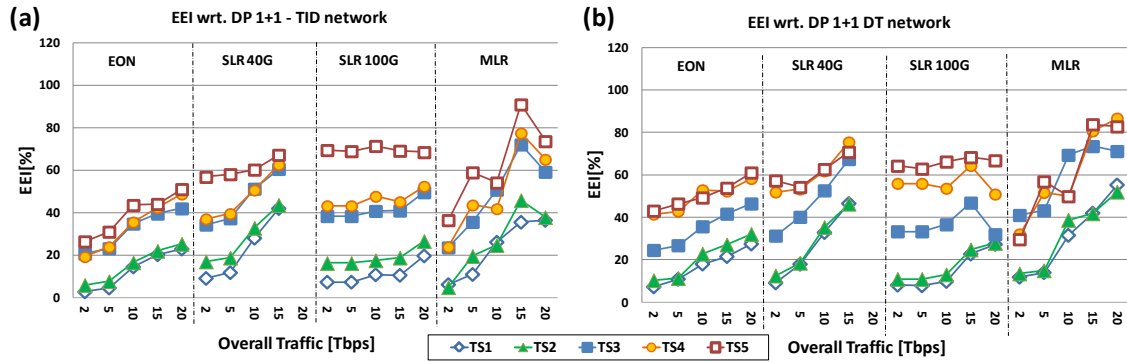

Figure 5.7. EEI of Diff QoP with respect to DP 1+1 in the static scenario for different network architectures, traffic scenarios, traffic load values in: (a) TID Network; (b) DT Network.

The results of EEI are shown in Figure 5.7a and Figure 5.7b in the TID and DT networks, respectively. It is worth noting that the results are only presented under non-blocking conditions (i.e. when SBR is equal to zero). For instance, the results in the case of SLR 40G with an overall traffic of 20 Tbps are not shown, as the network is not able to cope with all the traffic requests with TSPs of 40 Gbps. The results in both topologies lead to analogous conclusions regarding the performance of the different network architectures. Diff QoP permits to achieve positive EEI in most of the evaluated scenarios, but the degree of improvement depends on the particular TS, overall traffic and network architecture. These benefits are especially remarkable for WDM SLR and MLR, which are originally the least energy-efficient with DP 1+1 (Section 5.5.4). As for the five TSs, the most relaxed ones in terms of protection requirements such as TS4 and TS5 are the ones that can take relevant advantage of Diff QoP.

A common tendency that is observed is the general increase of EEI with overall traffic. The LPs of C1 are usually highly over-provisioned at low traffic values, implying that significant traffic volumes with more relaxed protection requirements can be upgraded to be groomed on existing

LPs to achieve a better utilization of the network resources. Therefore, the overall PC of the network with Diff QoP is not very distant from that of DP 1+1. However, as overall traffic grows, the chances of serving all the demands with the remaining capacity of the C1 LPs decrease. In these circumstances, Diff QoP becomes more effective in improving energy efficiency as a larger number of LPs can be established with protection schemes different from DP 1+1 (C1). Figure 5.8 shows the traffic that is actually conveyed in each traffic class in each TS when traffic upgrades are considered in the TID network (similar performance is observed for the DT network as well). The traffic percentages are compared with the original distribution of each TS. As can be seen, the distributions of traffic classes get closer to the original when traffic increases. For example, for an overall traffic of 2 Tbps in TS1, more than 80 percent of the traffic is conveyed in LPs of C1, when originally only the 45 percent required such high protection levels (large amounts of traffic C2, C3 and C4 are protected with DP 1+1). Nonetheless, even if EEI often increase with traffic load, there are some exceptions in MLR for particular TSs and overall traffic values (e.g. TS5 at 20 Tbps). This is explained by the different amount of traffic upgraded to higher QoP classes.

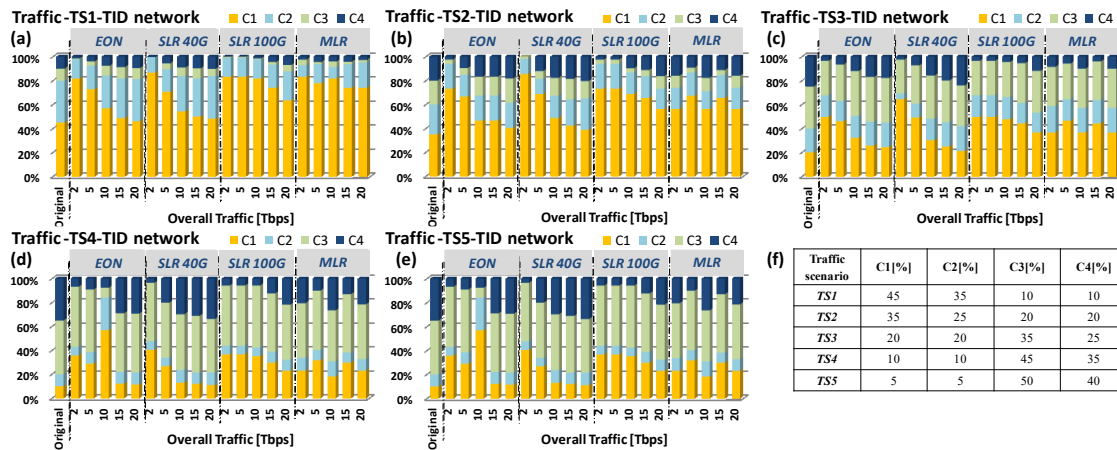

Figure 5.8. Comparison of the original distribution of traffic in each TS and the final distribution for each TS, traffic load value and network architecture in a static scenario: (a) TS1; (b) TS2; (c) TS3; (d) TS4; (e) TS5; (f) Table with percentages of traffic classes in each TS.

5.7.4.1.2. Spectral efficiency

The spectral efficiency can also be significantly enhanced by Diff QoP with respect to the inefficient utilization of spectral resources of DP 1+1. The SEI (Spectral Efficiency Improvements) values are shown in Figure 5.9a and Figure 5.9b for the TID and the DT networks, respectively. The values of SEI certainly depend on the particular network architecture and traffic requirements in terms of throughput and protection requirements (i.e. TS and overall traffic value). As for the EEI, higher SEI can be achieved in the more relaxed scenarios in terms of protection requirements (i.e. in those TS with lower percentage of traffic requiring DP) such as TS4 and TS5. However, where traffic requiring DP is predominant in the TS (like TS1 and TS2), Diff QoP can be disadvantageous for EON and MLR. These TS show that a very slight traffic differentiation results in a large number of low-capacity LPs being established with Diff QoP compared to the “all aggregated demand” protected with DP 1+1. A larger number of LPs may entail higher spectral occupancy (i.e. more wavelengths in MLR, and more subcarriers for data plus GBs in EON). In these cases, it must be carefully assessed whether applying DP 1+1 directly to all the aggregated traffic demand (C1+C2+C3+C4) from source to destination could be more convenient than differentiating the traffic (taking into account the potential EEI as well). This deterioration of

spectral efficiency with Diff QoP in TS1 and TS2 is not observed in SLR, where the shift from DP 1+1 to Diff QoP always translates into reduced spectral resources.

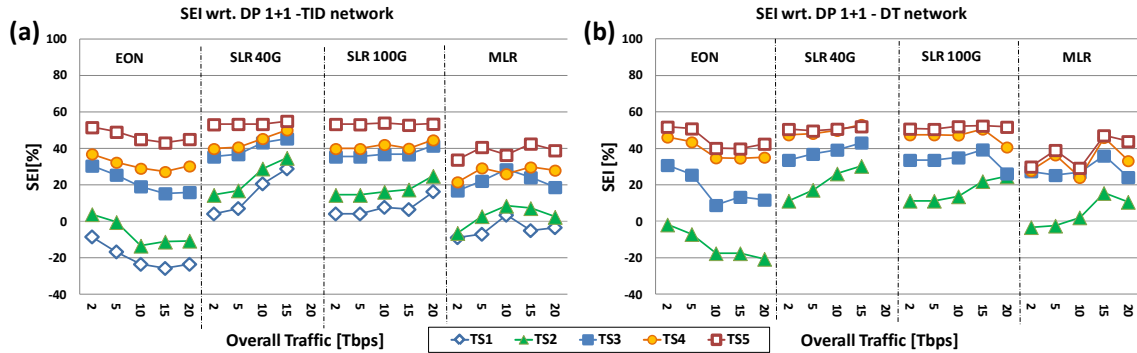

Figure 5.9. SEI of Diff QoP with respect to DP 1+1 in a static scenario for different network architectures, traffic scenarios, traffic load values in: (a) TID Network; and (b) DT Network.

5.7.4.2. Dynamic scenario

5.7.4.2.1. Energy efficiency

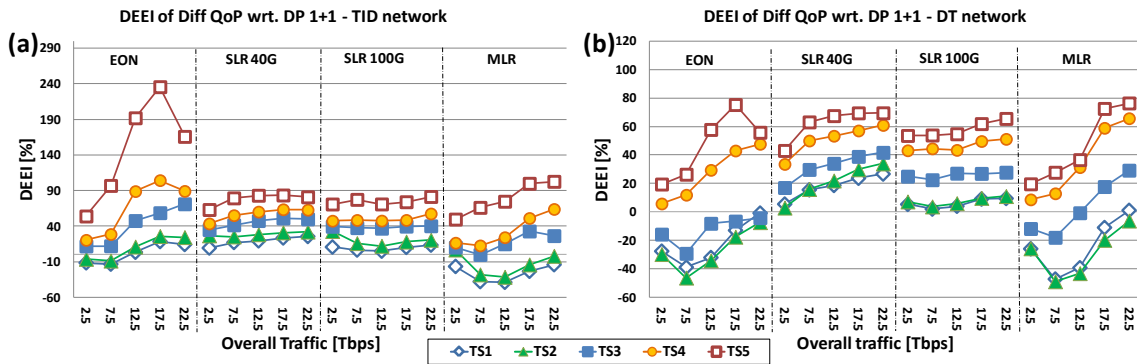

Figure 5.10. DEEI of Diff QoP with respect to DP 1+1 in a dynamic scenario for different network architectures, traffic scenarios, traffic load values in: (a) TID Network; (b) DT Network.

The DEEI results are shown in Figure 5.10a and Figure 5.10b for the TID and DT networks, respectively. As in the analyses for the dynamic scenario performed in Chapter 4, the simulations are carried out for 40,000 flow requests, and the system is considered to be in steady-state after the first 4,000 requests. As can be seen in Figure 5.10, different levels of DEEI are observed for the two evaluated network topologies; this is explained by the topology characteristics. Since the number of nodes is smaller in the DT network, there will be more flows concurring in the network with the same source and destination nodes. This fact certainly increases the chances of applying traffic grooming (higher probability of allocating the demands using the remaining capacity of higher QoP traffic classes, especially for C1). Upgrading significant traffic volumes to C1 leads to a situation closer to one where all traffic is protected with DP 1+1. On the contrary, the larger number of possible end-to-end LPs in the TID network (30 nodes compared to 14) results in higher DEEI thanks to the higher traffic differentiation and reduced grooming levels.

In addition to the network topology, the network architecture and traffic patterns strongly affect the DEEI. Similarly to the static scenario, as traffic increases, the DEEI become more noticeable as more flows concur in the network and the over-provisioning levels can be reduced

by applying grooming techniques. This is obviously beneficial in terms of energy efficiency because more traffic can be transmitted per fiber without considerably increasing the energy consumption. Additionally, higher DEEI are also achieved when the final distribution of transmitted traffic per class gets closer to the original, as shown in Figure 5.11 for the TID network. Nonetheless, lower traffic volumes are upgraded compared to the static case (Figure 5.8).

The different TS have a significant impact on the results. Diff QoP can generally bring valuable DEEI with respect to DP 1+1 in most of the TS. In particular, TS5 is the most beneficial in terms of DEEI at any overall traffic value thanks to the higher predominance of traffic belonging to C3 and C4 (SP and unprotected), which reduces the number of active TSPs for protection purposes. Nonetheless, there are also some exceptions where the application of Diff QoP might result in worse energy efficiency than DP 1+1. This may occur in TS1 and TS2 for EON and MLR, where most of the traffic still requires DP (C1 and C2). As a result, the energy efficiency can be worsened due to the establishment of a larger number of low-capacity LPs in these TS. This would eventually offer worse performance in terms of energy efficiency than grooming the entire demand and using DP 1+1 as protection scheme.

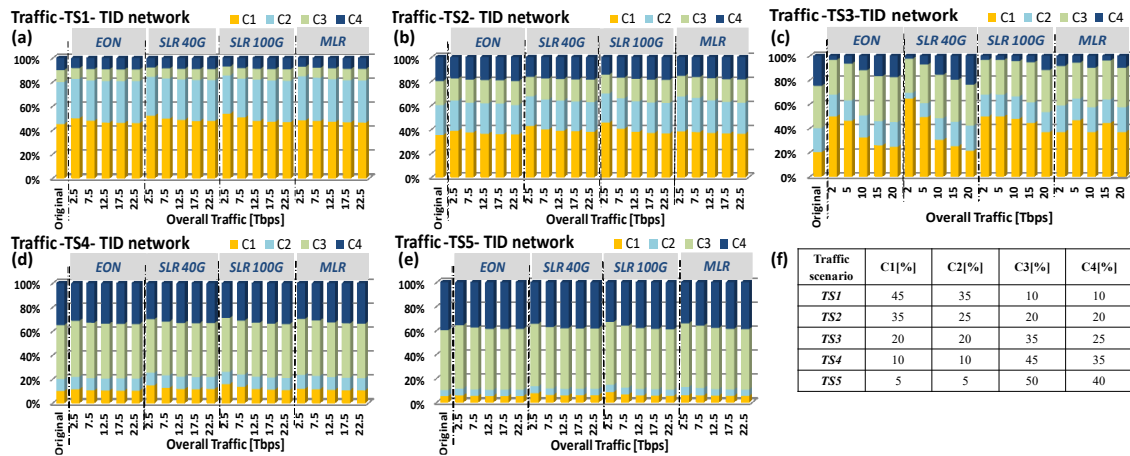

Figure 5.11. Comparison of the original distribution of traffic in each TS and the final distribution for each TS, traffic load value and network architecture in a dynamic scenario: (a) TS1; (b) TS2; (c) TS3; (d) TS4; (e) TS5; (f) Table with percentages of traffic classes in each TS.

5.7.4.2.2. Network blocking

Network blocking is indeed a very important performance measure in a dynamic scenario as it determines the number of resources that are needed to meet certain capacity requirements (single-fiber pair per link is considered). Figure 5.12a and Figure 5.12b show the DSBR for the TID and DT networks, respectively (note that those TSs of Diff QoP where blocking is zero are not shown). Diff QoP attempts to reduce the redundancy in terms of reserved spectral resources for protection and can also bring reductions in terms of DSBR with respect to DP 1+1 in most of the evaluated TS and network architectures.

The potential reduction of DSBR is extremely dependent on the TS. Thus, when moving from TS with predominance of C1 and C2 traffic (e.g. TS1 and TS2) to TS where the majority of the traffic belongs to C3 and C4 (e.g. TS5), DSBR can be significantly reduced. In fact, in some cases DSBR could be reduced down to zero at high traffic load in TS5 (e.g. in the DT network with SLR 100G and MLR with overall traffic values equal to 22.5 Tbps). On the other hand, Diff QoP can be disadvantageous compared to DP 1+1 in terms of DSBR in TS1 and TS2 (i.e. Diff QoP may end up

providing a larger number of low-capacity LP with increased spectrum occupancy). As in the static scenario, the network architecture also plays an important role on the performance of Diff QoP. Thus, in SLR networks, DSBR is always reduced compared to DP 1+1 since some of the wavelengths used for protection purposes can be released. However, for EON and MLR, the potential DSBR reduction strongly depends on the distribution of traffic classes (i.e. TS1 and TS2 suffer from higher DSBR than DP 1+1, whereas DSBR is reduced for TS3, TS4 and TS5).

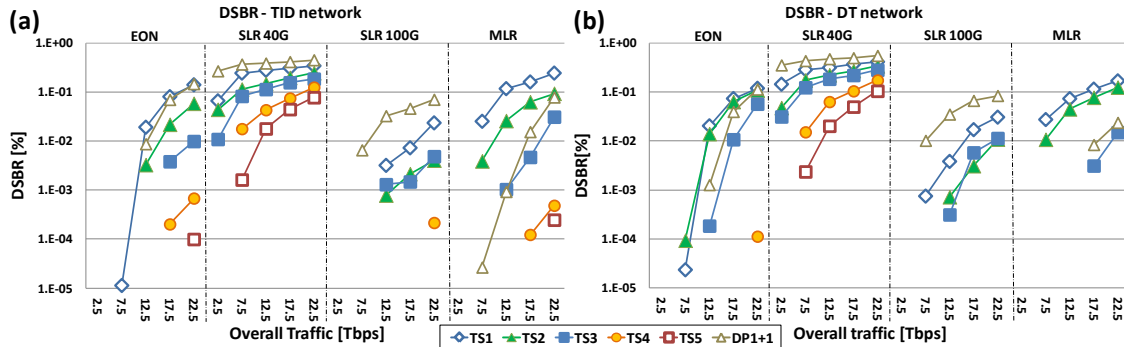

Figure 5.12. DSBR of Diff QoP with respect to DP 1+1 in a dynamic scenario for different network architectures, traffic scenarios, traffic load values in: (a) TID Network; and (b) DT Network.

5.7.5. Conclusions

A Diff QoP scheme can exploit the heterogeneous protection requirements of the clients or services to improve both the energy and spectral efficiency of optical transport networks. This scheme shows high potentials to address the efficiency problems of DP 1+1. The degree of performance improvements certainly depends on the particular requirements of resilience and requested throughput of the clients, as well as on the network architecture and operation modes. Generally, the more relaxed the protection requirements are (less clients requiring high protection), the more significant the benefits of Diff QoP will be. Moreover, the advantages of Diff QoP are shown to become more remarkable as overall traffic grows.

Regarding the operation of the network, in a static scenario, Diff QoP generally brings energy efficiency improvements regardless of the network architecture, but the spectral efficiency could be deteriorated with respect to DP 1+1 when traffic is low for some traffic scenarios. Up to 90 and 50 percent improvements can be achieved in terms of energy and spectral efficiency with respect to DP 1+1, respectively. In a dynamic or BoD network, on the other hand, the enhancements on energy and spectral efficiency are even more dependent on the traffic scenario and network architecture. The results show that energy efficiency can be enhanced up to 240 percent compared to DP 1+1 and the network blocking can even be reduced to zero at high traffic load conditions with EON architectures.

As far as network architectures are concerned, Diff QoP can be especially advantageous for the least efficient approaches: the WDM SLR (as shown in Section 5.6.4). In a WDM SLR network, Diff QoP allows for improving both the spectral and energy efficiency regardless of the traffic and network scenarios (i.e. the change from DP 1+1 to Diff QoP directly results in a smaller number of TSPs and wavelengths). However, the performance of Diff QoP for multiple line rate networks (EON and WDM MLR) is more influenced by the traffic conditions. Despite its general enhancements, Diff QoP might be disadvantageous in certain situations compared to DP 1+1, such as in the case where the majority of the traffic requires DP in dynamic scenarios.

All in all, adapting the network resources used for protection purposes seems to be a promising strategy to be applied in future networks. The proposed Diff QoP scheme can potentially replace the traditional DP 1+1 to enhance the energy and spectral efficiency of optical transport networks, while meeting the heterogeneous reliability requirements of the different services/users.

5.8. Conclusions of the chapter

Increasing the energy and spectral efficiency is becoming a key objective for operators of the optical data transport infrastructure. Nevertheless, maintaining high service availability and guaranteeing certain QoS are also essential in any network planning strategy.

The comparison of the common protection schemes shows the superior performance of SP in terms of EEPG and SBR compared to the DP ones (1+1 and 1:1). However, energy efficiency and reliability must be carefully assessed before adopting any new scheme as to be certain that the SLA terms are fulfilled. As a matter of fact, DP 1+1 is still the preferred choice to provide resilience in optical transport networks and fulfill the SLA terms (i.e. DP 1+1 provides the shortest RT). Accordingly, great attention has been devoted in this chapter to propose novel protection schemes that could improve the energy efficiency without sacrificing the reliability levels provided by DP 1+1. By doing so, more realistic energy-efficient strategies are provided which could eventually be applied by operators in the not so distant future.

As a first step towards an energy-efficient protected network, a novel protection scheme, DP TAPA, is proposed. This scheme exploits the daily traffic patterns to reduce the PC of the protection resources while the transmission on the WP remains unmodified. Consequently, the same reliability of DP 1+1 can be maintained, but reducing the PC of the TSPs and OXCs during low-traffic periods (e.g. nights or weekends). The simulation results show that significant energy savings can be obtained for different network architectures and scenarios, and especially when high traffic volumes are conveyed in the network. In particular, EON at high overall traffic loads can take advantage of DP TAPA thanks to the adaptive line rate feature. Nevertheless, this scheme still requires the reservation of redundant resources in the PPs (which also has an impact on the energy efficiency of the network).

Another potential strategy to improve energy efficiency (and also spectral efficiency) is based on exploiting the heterogeneous protection requirements of the customers of the optical infrastructure (institutions, companies, etc.), assuming that not all the services and users may require the high availability provided by DP 1+1. In fact, DP 1+1 is commonly applied to all traffic without considering the nature and requirements of the services. A Diff QoP scheme can offer an interesting trade-off between reliability and efficient utilization of both energy and spectral resources by matching the protection to the actual service requirements. In fact, Diff QoP can provide relevant energy savings over the conventional DP 1+1 for static and dynamic scenarios and network architectures. However, the degree of these savings depends on the protection requirements of the clients using the network resources (i.e. the lower the availability requirements are, the higher the potential energy and spectrum savings will be).

The EON paradigm shows a high potential to improve the energy efficiency used for protection purposes. First, the bandwidth elasticity and MF selection permits the adaptation of the LR in particular conditions (e.g. DP TAPA at low traffic load) to reduce PC. Moreover, EON enables the transmission of an energy-efficient MF on the WP and a robust one on the PP (which is commonly longer) if needed. In addition, EON provides lower SBR than fixed-grid WDM architectures with any protection scheme, which would allow for transmitting more traffic per fiber.

Overall, energy-aware approaches that take reliability and service availability into account are necessary to design future energy-efficient optical transport networks. These approaches have to consider more parameters than the ones proposed in unprotected scenarios.

To complete this chapter, an overview of the main findings is presented in Table 5.5.

Table 5.5. Overview of findings in Chapter 5.

Topic	Findings	Section
<i>Energy efficiency of common protection schemes</i>		
DP 1+1 vs. DP 1:1 vs. SP	SP shows superior performance in terms of EEGP and lower SBR than DP schemes.	5.5.4
Network architectures	EON shows better performance than fixed-grid WDM networks with any protection scheme.	5.5.4
Flexible protection schemes are more energy- and spectral-efficient than conventional DP 1+1, but may imply longer RT. EON architectures show a promising performance in terms of energy efficiency with any protection scheme		
<i>Energy-aware resilience schemes</i>		
Dedicated Protection Traffic-Aware Power-Aware	Adapting the transmission on the protection paths allows for reducing PC while maintaining the high reliability of DP 1+1. The EON architecture is the most beneficiary in this regard.	5.6.4
Differentiated QoP	Matching the specific protection requirements of each service/user offers a good trade-off between service availability and spectral/energy efficiency.	5.7.4
Adapting the protection resources to the actual needs of services/users and traffic variations can improve the energy efficiency of resilient networks without sacrificing reliability		

CHAPTER 6. ENERGY-EFFICIENT AMPLIFIER PLACEMENT

Future high-speed optical communications systems will be key to increase the capacity of optical transport networks in an energy-efficient manner. Despite the higher throughput and lower energy-per bit provided by these systems, they are based on higher modulation-order formats which make them not very feasible for the transmission over long distances. OAs play important roles to improve the signal power levels and thus extend the transmission reach. Until recently, the placement of in-line OAs has been fairly rigid, placing a minimum number of EDFAs in the links. This chapter evaluates novel amplification placement strategies to increase both the capacity and the energy efficiency of future high-speed WDM networks with MLR.

6.1. Motivation

Telecom carriers are facing the challenge of upgrading the network capacity to cope with the exponential growth of Internet traffic. Augmenting the capacity of the network entails the deployment of additional equipment which results in an increase of CapEx and OpEx due to, among other aspects, higher energy consumption. Therefore, operators are developing a growing interest in making their networks more energy- and spectral-efficient.

The core network, based on WDM technologies, will require significant capacity upgrades. Existing WDM networks have channel bit rates ranging from 10 Gbps to 40, 100, 200 and 400 Gbps. Furthermore, as traffic increases, the traffic demands are becoming more heterogeneous (i.e. traffic may increase at different pace within a network). This heterogeneity can be handled by the adoption of MLR architectures, which allow for a finer adjustment of the capacity to the service demand as shown in Chapter 4. MLR may reduce cost and also increase the spectral and energy efficiency of the network [122]. EON architectures may offer higher potentials to increase energy efficiency, but at the same time they are more disruptive and can be considered more of a long-term solution, while MLR approaches can already be applied in the network.

The employment of higher order modulation, such as 16-QAM, requires higher OSNR levels at the receiver to successfully recover the information (i.e. the higher the modulation order, the higher the required OSNR at the receiver). Therefore, in large networks, the transmission with high modulation orders can be unfeasible over long distances, especially for the link-disjoint dedicated PPs which could be significantly longer than the WPs. In order to achieve transparent reach over these long routes, low-order modulation formats, which are more robust, need to be employed. This will certainly worsen the spectral and energy efficiency of the network.

Another possibility to extend the transmission distance is based on the deployment of intermediate regenerators [123]. However, they entail a considerable increase of cost and energy consumption due to the OEO conversions. Thus, in large networks, the potential energy efficiency benefits offered by increased bit-rate per channel can be limited if additional OEO regenerations are needed for long-distance transmissions.

In optical transport networks, OAs are also the key elements to improve the signal power and extend the transmission reach. In common deployment scenarios, EDFAs are deployed along the fiber links with spacings of approximately 80 km. This strategy offered a good balance between performance and cost for previous generations of transmission technologies (≤ 100 Gbps).

However, for future systems with higher channel bit-rates, changing the conventional amplification strategies could be beneficial.

Novel approaches may include, for instance, the installation of HRE amplifiers to reduce the effective NF with respect to EDFA only amplification, or shortening of span lengths by placing additional OAs at intermediate link positions. Even considering that these strategies may entail increased energy consumption along the link, they could benefit the overall energy and spectral efficiency of the network if TSPs requiring lower energy per bit per spectral unit can be used. It is also worth mentioning that increasing the capacity transmitted per fiber is also advantageous to improve overall energy efficiency.

The previous ideas motivated the work presented in this chapter in order to assess which amplifier placement strategies can be useful to improve the energy efficiency as well as to achieve capacity increases coming from the enhanced spectral efficiency.

6.2. Related work

The potential benefits in terms of energy efficiency that can be provided by MLR architectures with respect to SLR were extensively studied in Chapter 4. The main advantage of MLR architectures is provided by the possible selection of several LRs to match the traffic demand, which reduces both the over-provisioning levels and the energy consumption. This was also shown by Chowdury et al. in [65] (SLR 100G seems to be more energy-efficient than MLR only at high traffic).

Higher-bit rate TSPs not only improve spectral efficiency, but energy efficiency (commonly new communication systems require lower energy per bit values) as well. However, energy efficiency is generally improved at the expense of reducing the transmission reach. Solutions allowing for extended transmission distance could then also be effective to improve the energy efficiency of the network. The optimum placement of a minimum number of REGs has been extensively covered in the literature and may help reducing the overall PC of the network by enabling higher data rate and energy-efficient transmissions. Nonetheless, it is worth noting that REGs also consume significant energy. In this regard, Xie et al. propose an EA technique for RP (i.e. energy-efficient impairment-constrained RP) in [123]. The authors aim at reducing the PC of MLR network with an MILP formulation and two heuristics. Since REGs generally consume significant amounts of power and are also expensive, alternative techniques to extend the transmission reach would be desirable from the energy- and cost-efficiency point of view.

OAs are commonly deployed separated by spans of approximately 80 km in the links (actual distances may vary between 50 and 100 km approximately) and nodes. As a matter of fact, OAs are not the most significant contribution to PC in transport networks. Nonetheless, in large networks with very long links (continental-sized network such as the Géant2 [97]), they may become the predominant source of energy consumption at low traffic as explained in [97] (they consume the same power independently of traffic load, but at high traffic the overall PC will be clearly dominated by the TSPs). Obviously if the span length is reduced, the contribution of OAs to the overall PC of the network may become more significant as well.

From a general network planning point of view, OAs are commonly assumed to be placed at fixed locations, with the number of publications which attempt to optimize the OAs locations being very limited. Some examples aimed at minimizing the total number of OAs to reduce cost while maintaining acceptable performance are presented in references [124-125] (and its extended version [122]) for WDM mesh and ring topologies, respectively.

As far as energy efficiency is concerned, most of the studies where OAs are considered as the targeted devices attempt to concentrate LPs into a set of links. For example, Shen et al. propose to design the network with a minimum number of active fibers and OAs to minimize the overall PC of the network [126] by using a MILP approach and a heuristic called mini fiber algorithm.

Some other approaches assume selectively switching-off some links according to the traffic variations. In this manner, OAs in the remaining links (not conveying any traffic) can be put into a low energy state or sleep-mode. This strategy can mainly be applied at low traffic conditions when it is easier to reroute the traffic in a few links. For instance, Coiro et al. also propose to selectively switch-off some links during low-traffic periods [127], thus achieving average energy savings of 35 percent. However, it should be mentioned that changing the normal operation of OAs may have some undesirable effects at the physical layer which must be thoroughly assessed in order to not cause any service disruption. Firstly, the wake-up time of the OA must be short enough as to enable the network to revert the traffic to the original links if needed. Secondly, the stability of the network might be affected when frequently turning on and off the OAs, making the devices more prone to failures. These implications are studied by Wiatr et al. in [128]. In particular, the authors evaluate the trade-off between the monetary energy savings of putting OAs into sleep-mode and their increased repair cost. They conclude that putting OAs into sleep-mode decreases the stability of the network in such a way that the repair costs remove the potential monetary savings achieved by lower energy consumption.

Strategies involving amplifier placements for future generations of MLR networks have not been extensively covered in the literature. Mitra et al. consider in [129] the placement of additional OAs (EDFA and Raman) and the migration to low-noise ROADMs as ways to improve the OSNR of certain LPs with the final objective of increasing the total capacity of the network. However, the performance in terms of energy efficiency is not evaluated by these authors.

6.3. General scope

The aim of this chapter is to compare the performance in terms of EEPG and capacity increases of different amplification strategies in WDM MLR networks. Special attention is devoted to propose and evaluate an EA strategy that selectively places additional in-line OAs to improve the overall EEPG of the network. In addition to EDFA, HRE is emerging as an effective amplification scheme to extend the transmission reach of future high-speed systems, as recently demonstrated in [130].

The goals of these studies are to assess: (1) How the energy and spectral efficiency can be improved by different amplification strategy; (2) The potential advantages of HRE over EDFAs in terms of energy and spectral efficiency. In summary, the main contributions of this chapter are:

- (i) Comprehensive description of the network parameters including a detailed explanation of the physical layer model implications.
- (ii) Detailed explanation of the RWA heuristic algorithms for future MLR networks (40/100/200/400 Gbps) and the proposed EA amplifier placement optimization.
- (iii) Evaluation of the energy efficiency improvements and capacity augments of the EA amplifier placement optimization strategies (additional placements and upgrades) in realistic deployment scenarios.
- (iv) Evaluation of the potential benefits that the deployment of HRE can bring with respect to only EDFAs in a realistic core network scenario.

Parts of the contributions of this chapter have been presented in the following publications:

1. J. López Vizcaíno, Y. Ye, F. Jiménez, A. Macho, P. Krummrich, "Optimized Amplifier Placements for Improved Energy and Spectral Efficiency in Protected Mixed-Line-Rate Networks," *Optical Fiber Communication Conference (OFC)*, pp. Th1E-5, Mar. 2014.
2. J. López Vizcaíno, Y. Ye, F. Jiménez, P. M. Krummrich. "Amplifier placements optimization for enhanced energy efficiency in optical transport networks," *IEEE International Conference on Communications (ICC)*, 2014, pp. 3700-3706, Jun. 2014.
3. J. López Vizcaíno, Y. Ye, F. Jiménez, A. Macho, P. Krummrich, "Increased energy efficiency and capacity for mixed-line-rate WDM networks with hybrid Raman-EDFA amplification," *European Conference on Optical Communication (ECOC)*, pp. 1-3. Sep. 2014.
4. J. López Vizcaíno, Y. Ye, V. López, P. Krummrich, "Cost Evaluation of Amplification Strategies for WDM Mixed-Line-Rate Networks," *International Conference on Transparent Optical Networks (ICTON)*, July 2015.

6.4. General network parameters

In this section, the parameters used along this chapter are described, which are significantly different from those in previous chapters in some cases.

6.4.1. Input and output parameters

The input and output parameters are similar to the ones presented in Table 4.1. The main differences lie in the information related to the physical layer model and the network topology as described in Sections 6.4.3 and 6.4.4, respectively. Among the network elements, new TSPs (i.e. 200 Gbps and 400 Gbps) and a new amplifier type (HRE) are considered in this chapter.

6.4.2. Power consumption models

Three energy-consuming devices for the optical transport network are considered: TSPs, OAs and OXCs.

- **TSPs:** A WDM MLR network with LRs of 40, 100, 200 and 400 Gbps operating with the ITU-T grid of 50 GHz is assumed. Hence, TSPs with different LR can be used in the network, i.e. 40 Gbps (QPSK), 100 Gbps (DP-QPSK), 200 Gbps (DP-16QAM) and 400 Gbps (single carrier DP-16QAM) are considered. The first three LRs occupy one 50 GHz slot whereas 400 Gbps requires two slots (100 GHz). For this new generation of TSPs, different PC values are assumed based on the internal information provided by different vendors in 2013. Thus, figures of 173.8 W, 243.4 W, 280 W and 481.9 W are considered for 40, 100, 200 and 400 Gbps TSPs, respectively. Note that the PC values of 40 and 100 Gbps have been updated with respect to the values used in previous chapters to account for the evolution to a second generation of MLR network with higher-speed TSPs.
- **OAs:** Two types of OAs are considered in this study: EDFA and HRE. An EDFA consumes 30 W per direction [98], whereas an HRE consumes 60 W (also per direction) [98]. Additionally, a PC overhead of 140 W is assumed per amplifier location to account for additional contributions to PC such as controller cards, fans, etc. [98].
- **OXCs:** The PC in watts of the OXC is assumed to depend on the node degree (N) and the add/drop degree (a) as follows: $PC = N \cdot 85 + a \cdot 100 + 150$, where 150W is the node overhead [98].

6.4.3. Physical layer constraints

In the previous chapters, for the sake of simplicity the fulfillment of physical constraints was evaluated by assigning a maximum transmission distances to each MF and then comparing it with the path length between the source and destination nodes. However, in this chapter, the physical constraints are more carefully assessed by computing the OSNR along the transmission path and

comparing the value at the receiver end ($ONSR_{RX}$) with the minimum requirement ($ROSNR$) of the TSP to recover the information.

In order to carry out the OSNR computation, the performance of the different elements involved in the data transmission over optical networks are taken into account, i.e. the network elements (TSPs, OAs, OXCs) and the medium (optical fiber). The signal is modulated at the transmitter (TX), propagated through the medium and detected at the receiver end (RX). OAs are used at the links to compensate for the transmission losses and increase the power level of the signal, and thus allowing for an extension of the transparent reach. However, an OA adds noise to the signal, which may affect the successful signal detection. Furthermore, the signal traverses several nodes and switching elements, which also bring in additional losses (e.g. insertion losses) that need to be compensated.

6.4.3.1. Transponders

As previously mentioned, four different transmission rates have been considered for the MLR architecture (40, 100, 200 and 400 Gbps). Depending on the bit rate, TSPs present different values of $ROSNR$, input power (P_{in}), RX sensitivity, and saturation power (P_{SAT}). The corresponding values are presented in Table 6.1.

The launched power at the TX has been set assuming that up to 80 channels with a channel spacing of 50 GHz can be transmitted per fiber and the maximum aggregated power cannot exceed 20 dBm (100 mW). Thus, the maximum launched power is set to 1 dBm per 50 GHz WDM channel. In the node design, P_{SAT} is a factor that has also been taken into account and must not be exceeded as to avoid any possible problem of the TSPs.

Table 6.1. Parameters of the different TSPs.

Capacity [Gbps]	Mod. format	P_{in} [dBm]	$ROSNR$ [dB]	RX sensitivity [dBm]	PC [W]	P_{SAT} [dBm]
40	QPSK	1	12 [131]	-14	173.8	0
100	DP-QPSK	1	14.5 [132]	-14 [133]	243.4	0 [133]
200	DP-16QAM	1	20.5	-14	280	0
400	DP-16QAM	4	23.5	-14	481.9	0

6.4.3.2. Optical cross connects

The switching elements (e.g. the WSS units) deteriorate the signal, which may eventually limit the transmission over long distances. Hence, some OAs are commonly placed at the nodes to compensate for these insertion losses.

The insertion losses in the add/drop stages are strongly determined by the particular node architecture. In this study, a CDC node model similar to that described in [134] and [135] is assumed. This OXC is based on a multicast switch (MCS), several WSS units and OAs as shown in Figure 6.1. The insertion losses are summarized in Table 6.2 and can be classified into three types:

- **Through channels:** Losses are inserted by the 2 WSSs that the LP traverses when passing through the node (input and output WSSs). The insertion loss of a single WSS is assumed to be 9.5 dB (6.5 dB [136] and 3 additional dB to account for extra losses at the WSS). Therefore, each channel passing through the node is penalized with a total loss of 19 dB. OAs are placed at the input (pre-amplifier) and output of each node (booster amplifier) to compensate for these losses.
- **Drop channels:** Each dropped LP (i.e. those with destination in the node) has to traverse

the input WSS and the MCS. The loss contribution of the MCS is assumed to be 22 dB according to [134] (i.e. requirement of 12 dB to accommodate from 1 to 16 channels due to the 1x16 splitter, 6 dB for transient tolerance, with a margin of 4 dB). An array of OAs is used at the drop stage to improve the signal power level before this is sent to the TSP (coherent RX). Furthermore, a loss of 9.5 dB is inserted by the input WSS.

- **Add channels:** The LPs generated in the node also suffer the losses inserted by the MCS (22 dB [134]). These losses are compensated by an OA array placed right after the TSP. Additional losses are introduced by the output WSS (9.5 dB) after that.

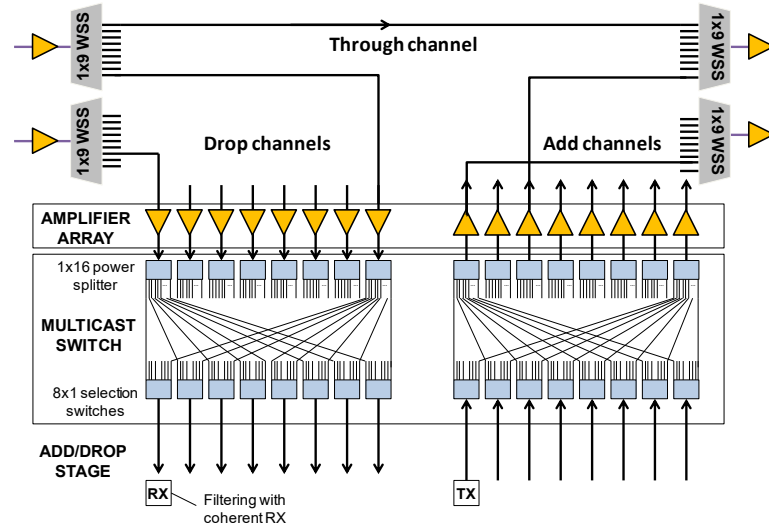

Figure 6.1. Node architecture model – CDC Add/Drop using MCS (based on [134] and [135]).

Table 6.2. Insertion/Splitting losses at the OXC.

Parameter	Loss [dB]
Total insertion loss for through channels	19 (9.5 dB at input WSS + 9.5 dB at the output WSS)
Total insertion loss for add channels	31.5 (22 dB at the MCS + 9.5 dB at the output WSS)
Total insertion loss for drop channels	31.5 (9.5 dB at the input WSS + 22 dB at the MCS)

6.4.3.3. Optical amplifiers

The optical signal is attenuated along the fiber and may also traverse several nodes and switching elements, all of which insert additional losses (e.g. insertion losses) that have to be compensated by OAs. However, as mentioned earlier, OAs also introduce noise due to ASE, which may affect signal detection and thus has to be taken into account. The OA array (composed of several low-noise OAs) and the booster are used to compensate for the insertion losses at the node. On the other hand, the pre-amplifier and booster aim at compensating for the losses of the previous span.

The following assumptions have been made to model the performance of OAs in the network: (1) Provide the same gain value over all the wavelengths; (2) Capable of providing a variable gain from 10 to 30 dB; (3) Operate in relatively highly loaded links.

In order to evaluate the performance of OAs, the NF is the most relevant parameter to consider. The NF is a measure which indicates how much noise the OAs adds to the signal, and it strongly depends on the gain provided by the amplifier. The NF versus gain dependence has been depicted in Figure 6.2 (obtained from equipment of different vendors) for the two types of OAs evaluated. It is worth mentioning that an ideal amplifier with linear gain- NF is assumed, but there is currently no single OA able to provide such a wide range of gain, and the NF of different OAs for common

gains may differ from each other due to the different fabrication processes. HRE shows significantly lower NF values than EDFA for the same gain value as can be seen. The gain of the OAs (and so the NF) is determined by the functionality and placement of these in the network:

- **Amplifier gain for in-line OA and pre-amplifier:** The gain of each OA is adjusted to provide a specific power value at its output (input power of the following span) and compensate for the losses of the previous span.
- **Amplifier gain for OA at the booster amplifier:** The gain values for the booster and pre-amplifier must be high enough to compensate for the insertion losses at the OXC for through and added channels.
- **Amplifier gain for the array of OAs:** Gain has to be adjusted to compensate for the loss at the MCS and provide the desired power level at the input of the TSP and the WSS unit placed at the output of the node.

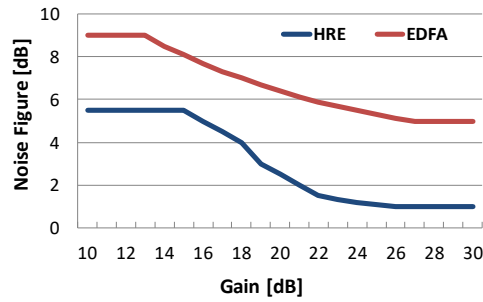

Figure 6.2. Gain versus NF values for EDFA and HRE amplification.

6.4.3.4. Optical fiber

Regarding the medium, an attenuation coefficient α of 0.22 dB/km is assumed for the SMF [138]. Moreover, extra losses must be considered in the end-to-end transmission [138]:

- **Good splice:** As the inter-amplifier links are composed of multiple fiber segments, losses of 0.05 dB corresponding to an acceptable fused splice are considered for every 2 km of fiber (typical value for field deployments).
- **Connectors between OAs:** Extra loss of 2 dB coming from the different connectors used between OAs and line cards at both ends.
- **Splices from maintenance tasks:** A 1.5 dB margin is considered to account for losses due to potential extra splices coming from maintenance tasks, the existence of fiber segments connected to optical distribution frame at central exchanges, etc.

In summary, the span losses in decibels can be calculated as follows: $(Loss[dB] = \alpha L [km] + (0.05L[km]/2) + 2 + 1.5)$, where L is the span length in kilometers.

6.4.3.5. Physical transmission feasibility

Once the physical parameters of the different elements involved in the transmission have been explained, the OSNR can be computed. Eq. (22) is used to determine the OSNR level of the transmission system, assuming ASE as the dominant noise source for a single span [137].

$$OSNR_{idB}[dB] = 301.787 + P_{in}[dBm] - NF_i[dB] - 10 \log(f) - 10 \log(Br) \quad (22)$$

Where $OSNR_{idB}$ is the OSNR at the output of the OA (after the span), P_{in} is the power at the input of the OA, NF_i is the noise figure of the amplifier, f (in Hz) is the channel center frequency, and Br (in Hz) is the resolution bandwidth (typically, 0.1 nm (12.5 GHz) is considered as Br).

As shown in the example of Figure 6.3, the power at the output of the in-line amplifier is always set to the same value, i.e. equal to the launched power of the TSP in Table 6.1. Accordingly, the gain of the in-line OA is adjusted to compensate for the loss of each span and have the desired power at the beginning of the span. In this manner, NFi is the only value that changes in the calculation of the OSNR for the different spans, as it depends on the selected OA gain value. Concerning the OA in the nodes, the pre-amplifier has a variable gain value and compensate for the loss of the previous span, while the OA array and the booster have fixed gain values to compensate for the losses at the MCS and output WSS, respectively.

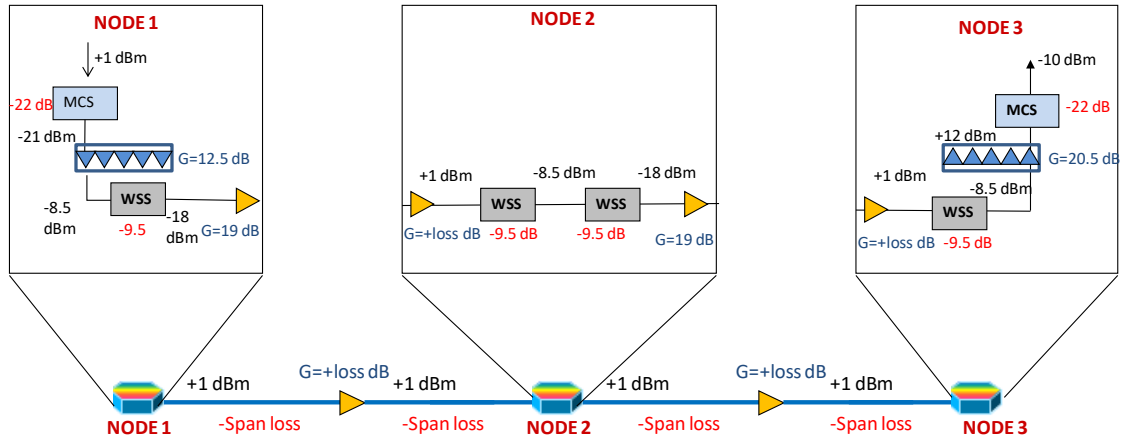

Figure 6.3. Example of power levels, amplifier gains, and losses in and end-to-end transmission between node 1 and node 3 (traversing node 2) with launched power equal to 1 dBm (e.g. 100 Gbps transmission).

In a system composed of more than one OA, $OSNR_{RX}$ can be calculated by the individual OSNR contribution of each noise source as defined in Eq. (23), which is given for linear values. It has to be noted that even if the gain of the OA compensates for the span losses, OAs with different gain may have different NF values [137].

$$\frac{1}{OSNR_{RX}} = \frac{1}{OSNR_S} + \frac{1}{OSNR_1} + \frac{1}{OSNR_2} + \dots + \frac{1}{OSNR_N} \quad (23)$$

Where $OSNR_{RX}$ is the final OSNR at the receiver, $OSNR_S$ is the OSNR of the laser source (typical values for a distributed feedback laser are in the range between 35 and 57 dB), and $OSNR_k$ is the OSNR value after each individual OA, with $k=1, \dots, N$.

Once the OSNR ($OSNR_{RX}$) and power (P_{RX}) at the receiver are calculated (according to the methodology described in [137]), it is possible to determine whether transparent reach is feasible, for the evaluated MF by the fulfillment of Eq. (24). In fact, $OSNR_{RX}$ must be greater than or equal to the $ROSNR$ value plus a margin of 3 dB (Mar_{dB}) that accounts for possible penalties due to operational tasks, aging, non-linear effects, etc. Furthermore, in order to allow the TSP to operate in normal conditions, P_{RX} must be above the minimum power required at the RX (RX sensitivity) in Eq. (25). Additionally, the total aggregated power ($Aggregated P_{RX}$) received at each coherent TSP (i.e. summation of the maximum power of all the optical signals after the selection switch; 8 channels in the node model shown in Figure 6.1) must be below the P_{SAT} as specified in Eq. (26). The launched power and gain of the OAs are adjusted in order to guarantee that Eq. (25) and Eq. (26) are fulfilled, whereas Eq. (24) depends on the particular LP, line rate and selected path (i.e. particular OAs and nodes that are traversed by the LP under evaluation).

$$OSNR_{RX}[dB] \geq ROSNR[dB] + Mar_{dB}[dB] \quad (24)$$

$$P_{RX}[dB] \geq RX \text{ sensitivity } [dB] \quad (25)$$

$$Aggregated P_{RX}[dBm] \leq P_{SAT}[dBm] \quad (26)$$

6.4.4. Network topologies

The network scenario considered in this study is the Spanish core network model of TID specified within the European Union-funded project Idealist [138] and depicted in Figure 6.4. This topology is composed of 30 nodes and 46 bi-directional links, same as the one presented in Section 4.4.4. However, this model also defines 66 fixed in-line amplifier placements and 207 potential intermediate locations where additional amplifiers could be placed (assuming some equipment is already present in those locations) [138]. Transparent connectivity (no regeneration) and one fiber pair per link have been assumed in this study.

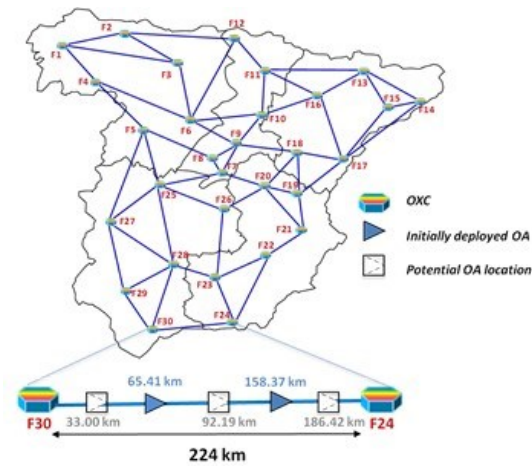

Figure 6.4. TID network scenario, showing one particular link with both fixed and potential amplifier locations [138].

6.5. Energy-efficient selective placement of additional amplifiers

6.5.1. Motivation and scope

This section is devoted to evaluating the selective placement of additional OAs at pre-defined intermediate locations in the links to improve the overall EEPG and increase the capacity of the network. The evaluation is performed for a realistic nation-wide network scenario with WDM MLR operation (40/100/200/400 Gbps) and using DP 1+1 as the protection scheme.

The continuous and dramatic traffic growth is pushing operators to upgrade their networks as the capacity might be exhausted in the not-so-distant future. Accordingly, significant effort is being put in the research community and vendors to make system beyond 100 Gbps a reality for long-haul networks. As mentioned before, despite the obvious enhancement in spectral and energy efficiency, the higher ROSNR sets a serious limitation for the application over long distances. In addition to the potential solutions that may be taken to successfully recover the signal at the receiver end (e.g. improvements at the DSP, new types of fiber, deployment of REGs), reducing the amplifier spacing (or span length) could be an effective solution to improve the OSNR levels and allow for the employment of higher order MFs that are more energy-efficient per spectrum unit. Also, OAs offer the possibility of simultaneously improving the signal power level

of more than one channel (all the ITU-T C-band spectrum) that could be advantageous compared to REGs which, in spite of their easier installation (i.e. at the node), are capable of improving the power of a single optical signal.

The deployment of more OAs implies increased PC at the network links (i.e. 30 W or 60 W per direction for EDFA or HRE, respectively, plus an overhead contribution of 140 W per amplifier location [98]). But at the same time, adding more OAs may reduce the PC at the nodes if more energy-efficient TSPs can be used. The study of this interesting trade-off motivated this activity to assess the impact in terms of energy efficiency of selectively placing new OAs.

As explained earlier, a realistic network deployment scenario is considered where EDFAs are already placed at fixed locations and specific intermediate locations are available to install new OAs. The strategy of keeping the currently deployed in-line EDFAs and only exploring the deployment of additional ones could be less disruptive and easier for the operator than optimizing all the amplifier placements (i.e. including changes in current OA locations).

In order to evaluate this strategy, EA heuristic algorithms have been developed to solve the initial RWA problem and the posterior optimization by selectively adding new OAs at intermediate link locations. The optimization phase considers the placement of new OAs provided that the overall EEPG of the network can be enhanced.

Two potential scenarios for evaluation have been considered. The first explores the potential EEPG improvement and capacity increases of placing additional EDFAs, whereas the second scenario considers the deployment of HRE to assess whether its low NF may be advantageous to further improve EEPG despite its higher PC than EDFA.

6.5.2. Network parameters

6.5.2.1. Network architectures

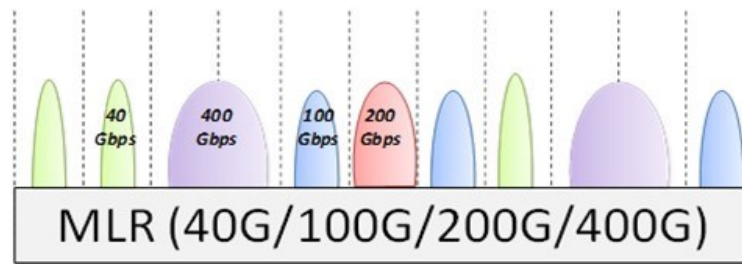

Figure 6.5. Spectrum of the second generation of WDM MLR network (40/100/200/400 Gbps).

A WDM MLR architecture with LRs of 40, 100, 200 and 400 Gbps operating with the ITU-T grid of 50 GHz is assumed with a total number of 80 wavelenghts (per link) over the C-band, as depicted in Figure 6.5. Since fixed channel spacing is considered, the first three mentioned LRs occupy one slot of 50 GHz; whereas the 400 Gbps, whose signal bandwidth does not fit on a 50 GHz slot, requires the occupancy of two slots (100 GHz). Despite occupying the same bandwidth as 2 TSPs of 200 Gbps, a 400 Gbps TSP will provide advantages such as lower energy per bit, lower cost, and reduced floor space needs.

This can be considered as a second generation of MLR with respect to the one presented in previous chapters (Chapters 4 and 5). In this case, only coherent TSPs are used and the legacy 10 Gbps TSPs (based on NRZ-OOK) have been replaced. Removing the 10 Gbps TSPs makes the division into two bands and related insertion of a GB unnecessary.

6.5.2.2. Network operation modes

A static scenario where wavelengths are quasi-permanently assigned to a particular end-to-end peak-traffic demand is considered.

6.5.2.3. Traffic conditions

A TM with an overall value of 1.65 Tbps for the TID network with 46 bi-directional traffic demands has been adopted as a reference [138] and scaled up to emulate different traffic load conditions (up to up to 38.02 Tbps).

6.5.3. Methodology

EA heuristics algorithms for the RWA in WDM MLR networks (40/100/200/400 Gbps) and posterior optimization by placing additional OAs to improve EEPG are proposed. In fact, the methodology followed can be divided into two stages: initial RWA and optimization phase.

6.5.3.1. EA initial RWA for mixed line rate (40/100/200/400 Gbps)

EA-RWA WDM MLR (40/100/200/400 Gbps) algorithm: Main flow

1. Sort the demands of the TM in descending order of demand value in *ListOfDemands*
 2. $DemandIndex \leftarrow 1$
 3. **while** $DemandIndex \leq size(ListOfDemands)$
 4. $HighestEEPGmetric \leftarrow 0$
 5. Initialize *MostEfficientAllocation*
 6. **Evaluation of LP establishment according to Algorithm 15 (MLR 40/100/200/400G)**
 7. **if** *MostEfficientAllocation exists*
 8. Establish LP for *MostEfficientAllocation* (path, wavelength IDs, LRs)
 9. **else**
 10. Demand is blocked
 11. **end if**
 12. $DemandIndex \leftarrow DemandIndex + 1$
 13. **end while**
 14. Calculate performance measures (SBR, EEPG)
 15. **if** *LinkList exists (i.e. there are "NON-OPTIMIZED" LPs to optimize)*
 16. Proceed with optimization phase (Algorithm 16 or Algorithm 17)
 17. **end if**
-

Algorithm 14. Main flow for the RWA MLR (40/100/200/400 Gbps) algorithm.

Similarly to the heuristics presented in previous chapters, the optimization target is optimizing the overall EEPG of the network. The RWA for this "second generation" of MLR networks with 40, 100, 200 and 400 Gbps is significantly different from the "first generation" with 10, 40 and 100 Gbps (explained in Section 4.5.3.1.2). The main differences in the operation of the algorithm lie in:

- **GB is not needed:** The absence of 10 Gbps transmission makes it unnecessary to include a GB between the legacy 10 Gbps (NRZ-OOK) and the 40/100 Gbps based on xPSK modulation formats.
- **Presence of 400 Gbps:** Assuming a fixed-grid of 50 GHz, a 400 Gbps transmission require the utilization of two contiguous wavelengths (i.e. 100 GHz).
- **Physical constraints:** A more detailed model based on the computation of the OSNR is used to determine the transmission feasibility, which differs from the simplified transmission distance model used in Algorithm 3.

Algorithm 14 presents the main flow carried out for the RWA, which is similar to the one presented in Section 4.5.3.1– Algorithm 1. The network topology considers only the fixed locations where OAs are assumed to be installed. The demands from the TM are initially sorted

according to the “highest demand first” strategy in *ListOfDemands*. After that, each demand of *ListOfDemands* is processed one-by-one to be provisioned with DP 1+1.

EA-RWA WDM MLR (40/100/200/400 Gbps) algorithm with DP 1+1: Establishment of new LP

```

1. Calculate the possible LRComb for TrafficDemand and sort them in descending order of TSP's EEPG
   in LRCombList
2. LRCombIndexWP  $\leftarrow 1$ 
3. TotalHighestEEPGmetric  $\leftarrow 0$ 
4. Initialize MostEfficientAllocation
5. while LRCombListIndexWP  $\leq$  size(LRCombList)
6.   Calculate KSP from source to destination and include them in ListOfWorkingPaths
7.   for each candidate path of ListOfWorkingPath
8.     Calculate link-disjoint KSP from source to destination and include them in ListOfProtecPaths
9.     if ListOfProtecPaths is not empty (i.e. at least one link-disjoint path exists)
10.      HighestEEPGmetricWP  $\leftarrow 0$ 
11.      Initialize MostEfficientAllocationWP
12.      Compute OSNR for the end-to-end transmission
13.      if transparent reach in candidate WP for LRComb as in Eq. (24), i.e.  $OSNR_{rx} \geq ROSNR$ 
14.        Search for common wavelengths in the links of the WP (400G requires 2 contiguous  $\lambda$ s)
15.        if allocation possible in candidate WP
16.          Calculate EEPGMetricWP (2)
17.          if (EEPGMetricWP  $>$  HighestEEPGmetricWP) or (HighestEEPGmetricWP  $== 0$ )
18.            HighestEEPGmetricWP  $\leftarrow$  EEPGMetricWP
19.            Save allocation info (path, wavelengths, LRComb) in MostEfficientAllocationWP
20.          end if
21.        end if
22.      end if
23.    end for
24.    if HighestEEPGmetricWP  $\neq 0$ 
25.      LRCombIndexPP  $\leftarrow 1$ 
26.      while LRCombListIndexPP  $\leq$  size(LRCombList)
27.        Calculate KSP from source to destination and include them in ListOfWorkingPaths
28.        for each candidate path of ListOfProtecPaths
29.          HighestEEPGmetricPP  $\leftarrow 0$ 
30.          Initialize MostEfficientAllocationPP
31.          Compute OSNR for the end-to-end transmission
32.          if transparent reach in candidate PP for LRComb as in Eq. (24), i.e.  $OSNR_{rx} \geq ROSNR$ 
33.            Search for common wavelengths in the links of the PP (400G requires 2 contiguous  $\lambda$ s)
34.            if allocation possible in candidate WP
35.              Calculate EEPGMetricPP (2)
36.              TotalMetricEEPG = EEPGMetricWP + EEPGMetricPP
37.              if (TotalMetricEEPG  $>$  TotalHighestEEPGmetric) or (TotalHighestEEPGmetric  $== 0$ )
38.                TotalHighestEEPGmetric  $\leftarrow$  TotalMetricEEPG
39.                Save allocation info in MostEfficientAllocation (including WP and PP info)
40.              end if
41.            end if
42.          end for
43.          LRCombIndexPP  $\leftarrow$  LRCombIndexPP + 1
44.        end while
45.      end if
46.    if TotalMetricEEPG  $\neq 0$ 
47.      if LRCombIndexWP and/or LRCombIndexPP equal to 1 (i.e. optimum transmission)
48.        Mark LP (WP and/or PP) as "OPTIMUM"
49.      else
50.        Mark LP (WP and/or PP) as "NON-OPTIMIZED" and store links in LinkList
51.      end if
52.    end if
53.    Break
54.  end if
55.  LRCombIndexWP  $\leftarrow$  LRCombIndexWP + 1
56. end while

```

Algorithm 15. EA-RWA algorithm for WDM MLR (40/100/200/400 Gbps) network: Establishment of new LP.

In an MLR network, a particular demand can be provisioned by different *LRComb*. Following the defined optimization objective, the algorithm attempts to establish LP with the *LRComb* providing the highest possible EEPG. An LP can be established provided that the two following conditions are fulfilled:

- (1) Enough and common (i.e. with the same wavelength ID) wavelength resources are available in all the links of the candidate path (and thus the continuity constraint can be fulfilled). It is worth mentioning that two contiguous wavelengths must be assigned for 400G transmissions.
- (2) The transmission is feasible in terms of OSNR, i.e. transparent reach is possible if $OSNR_{RX}$ is greater than or equal to the ROSNR for all the transmission rates contained in *LRComb* as shown in Eq. (24) (e.g. for a demand of 500 Gbps and a *LRComb* composed of 1x400Gbps +1x100Gbps, $OSNR_{RX}$ must be higher than the ROSNR of a 400 Gbps TSP).

As shown in Algorithm 15, the RWA is carried out considering DP 1+1 as protection scheme. Therefore, the candidate WPs are first calculated from source to destination and stored in *ListOfWorkingPaths*. Then the RWA is evaluated with the first *LRComb* from *LRCombList* in all candidate WPs from *ListOfWorkingPaths*, provided that at least a link-disjoint PP exists (the PPs for each particular candidate WP are stored in *ListOfProtecPaths*). For those candidate WPs where the two previous conditions can be met with the evaluated *LRComb*, an *EEPGMetricWP* is calculated as in Eq. (2) and the information (path and *LRComb*) is stored accordingly in *MostEfficientAllocationWP* for the path providing the highest metric value (*HighestEEPGMetricWP*).

Once the WP has been evaluated and the best solution in terms of EEPG has been achieved, the process is repeated to select the most convenient PP (link-disjoint path) for the path stored in *MostEfficientAllocationWP*. In fact, the process is repeated starting from the first *LRComb* in *LRCombIndex* in the candidate PPs. If a solution is found, a metric is calculated for the PP (*EEPGMetricPP*) using Eq. (2) and finally an overall metric which accounts for both the WP and PP is obtained by the summation of *EEPGMetricWP* and *EEPGMetricPP*. The information regarding the most efficient combination of WP and PP in terms of EEPG is stored in *MostEfficientAllocation*. If a solution is not reached with the first *LRComb*, the process is repeated for the ones following in *LRCombList*.

Finally, if the RWA evaluations on both the WP and PP were successful, the corresponding LPs will be established based on the information stored in *MostEfficientAllocation*. Those LPs established with the optimum *LRComb*, the first in the list (i.e. *LRCombIndexWP* or *LRCombIndexPP* equal to 1), the LP(s) is/are classified as "OPTIMUM" (i.e. no further optimization in terms of EEPG would be possible). Otherwise, the procedure is repeated considering the following *LRComb* in the list for the WP (and so on the PP). If the allocation is possible with a *LRCombIndex* different from one, the LP would be marked as "NON-OPTIMIZED" and included in the list of links traversed by LPs to optimize (*LinkList*) since the achieved solution is not the optimum one in terms of EEPG. As shown in the example presented in Table 6.3, *LinkList* includes information about the link ID, number of "NON-OPTIMIZED" LPs traversing the LP and their corresponding IDs (LPIDs). If no solution is found after evaluating the entire *LRCombList* in all the candidate paths, the demand will then be blocked.

Once the RWA for all the traffic demand is evaluated, the performance measures such as EEPG and SBR can be calculated with Eq. (5) and Eq. (6), respectively.

6.5.3.2. Selective placement of additional in-line optical amplifiers

Algorithm for the selective placement of additional in-line OAs: Optimization phase

1. Sort links from *LinkList* in descending order of number of “NON-OPTIMIZED” LPs
2. $N_{Amp} \leftarrow 1$
3. $NSimLinksToOptimize \leftarrow 1$
4. **while** ($NSimLinksToOptimize \leq 4$) and (*LinkList* is not empty)
5. **while** ($N_{Amp} \leq 4$) and (*LinkList* is not empty)
6. **for each** $NSimLinksToOptimize$ group of link in *ListOfLinks*
7. Place N_{Amp} OAs in N_{Amp} potential amplifiers locations in $NSimLinksToOptimize$
8. **for each** “NON-OPTIMIZED” LP traversing the links to optimize
9. Re-compute OSNR for the end-to-end LP transmission with the “OPTIMUM” $LRComb$
10. Determine transparent reach possibility for $LRComb$ as in Eq. (24)
11. **if** transparent reach
12. Store information about LP in *UpdatedAllocation* (Wavelength IDs, $LRComb$)
13. **end if**
14. **end for**
15. Compute potential EEPG improvements with *UpdatedAllocation*
16. **if** EEPG improvement > 0
17. Deploy OA in the network physical topology
18. Modify resource allocation according to *UpdatedAllocation*
19. Delete optimized LPIDs from *LinkList*
20. **if** no more LPs to optimize in *Link*
21. Delete *Link* entry from *LinkList*
22. **end if**
23. **end if**
24. **end for**
25. $N_{Amp} \leftarrow N_{Amp} + 1$
26. **end while**
27. $NSimLinksToOptimize \leftarrow NSimLinksToOptimize + 1$
28. **end while**
29. Re-run RWA in the updated physical topology (Algorithm 1)

Algorithm 16. Selective placement of additional in-line OAs to improve EEPG.

As shown in Algorithm 14, once the RWA has been evaluated for all the demands in the TM, if there is some “NON-OPTIMIZED” LP in *LinkList*, the optimization phase will be carried out.

In particular, the algorithm described in Algorithm 16 evaluates whether the placement of additional OAs (at the predefined potential amplifier locations) in the links traversed by “NON-OPTIMIZED” LPs could result in enough OSNR improvement to enable the transmission with the optimum $LRComb$ (which provides the highest EEPG).

First, based on the information stored in *LinkList*, the affected links are sorted in descending order of the number of carried “NON-OPTIMIZED” LPs, as in the example shown in Table 6.3 (another ordering strategy based on the optimization of the links with higher span losses first is also considered, leading to analogous results). Then, the different links are evaluated for the placement of a N_{Amp} (initially just one) OAs at the predefined intermediate amplifier locations of the link. When more than one potential location is available in a particular link to place the OAs, the ones providing the largest OSNR improvement will be selected. After placing the additional OAs, the end-to-end transmission feasibility for the LPs traversing the mentioned link is re-evaluated for the optimum $LRComb$ ($LRCombIndex$ equal to 1). This process is repeated for all the affected LPs and those that can be sufficiently improved in terms of OSNR to employ higher line rates are stored in the *UpdatedAllocation* with the upgraded line rate configuration.

After evaluating the optimization of all the LPs, the new OAs location(s) is/are included in the updated configuration of the network and the transmission is modified accordingly (i.e. spectral resources and transmission), if the overall EEPG of the network can be enhanced (taking the spectral occupancy reduction and the difference between the reduction of PC at the TSP and the

extra PC of the new OAs into account). Once it is proven that the EEPG of a given LP is optimized, it is marked as “OPTIMUM” and deleted from *LinkList*.

The previously mentioned steps are repeated for all the affected links in *LinkList* until all the “NON-OPTIMIZED” LPs are optimized or all the possible combinations of additional OAs are evaluated. The introduction of up to four additional amplifiers (*NAmp*) per link can be considered. Moreover, the simultaneous placement of more than one OA in different links (*NSimLinksToOptimize*) can be evaluated as well. In fact, the placement of OAs in up to three different links can be simultaneously analyzed (*NSimLinksToOptimize* smaller than or equal to 4).

After evaluating the optimization for all the possible combinations of additional OAs, the RWA in Algorithm 14 is repeated over the final network configuration to check whether the spectrum occupancy reduction enables the allocation of the initially blocked demands, so that SBR can be reduced.

Table 6.3. Example of *LinkList*.

Link ID	Number of LPs	LPIDs
4	5	20, 40, 56, 76, 54
35	4	40, 56, 76, 98
40	1	20

6.5.4. Numerical results

6.5.4.1. Additional erbium-doped fiber amplifiers

6.5.4.1.1. Case study

Example: Traffic demand of 720 Gbps from F16-F17 with DP 1+1

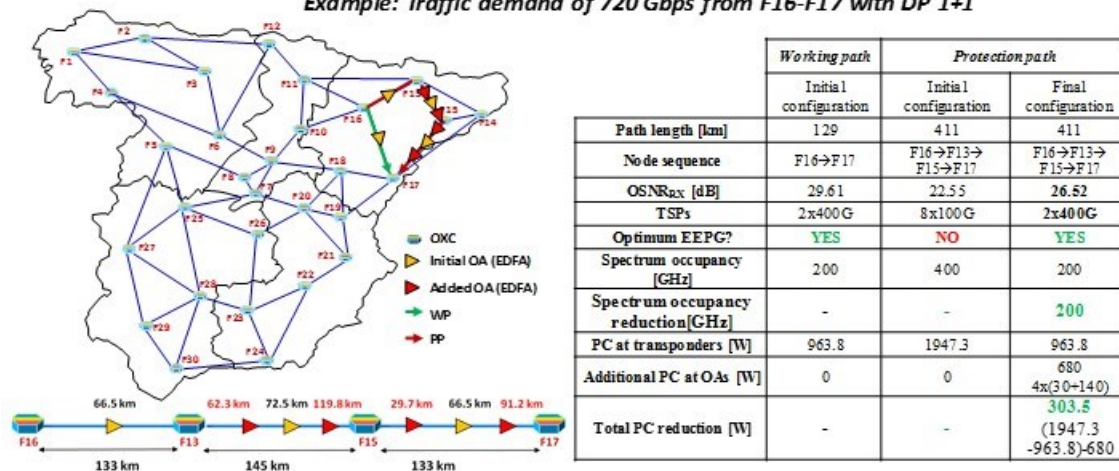

Figure 6.6. Case study with placement of additional EDFA: Example of a traffic demand of 720 Gbps between nodes F16 and F17 with DP 1+1 before and after adding two EDFAs in two of the links (F13-F15 and F15-F17).

Figure 6.6 presents an example of optimization for a demand of 720 Gbps between nodes F16 and F17 with DP 1+1. The WP can be provisioned with two TSPs of 400 Gbps, which is the optimum solution in terms of spectral and energy efficiency (i.e. provides the highest *EEPGMetric*). However, the PP suffers from higher penalties due to the longer length (411 km compared to 129 km) and the two intermediate nodes that the LP has to traverse. Therefore, it is not possible to employ

400 Gbps in this path as the $OSNR_{RX}$ is lower than the requirement, i.e. for 400 Gbps transmission it is 25.55 dB instead of the required 26.5dB (23.5 plus the 3-dB margin). Accordingly, it is necessary to deploy eight TSPs of 100 Gbps ($OSNR_{RX}$ with 100 Gbps is 22.55 dB, which is above the ROSNR for this transmission rate). This is certainly not the most efficient solution in terms of EEPG and the LP is classified as “POSSIBLE TO OPTIMIZE”.

When considering the selective placement of additional OAs (as in Algorithm 16), it is found that the placement of four additional EDFAs on the PP can improve the OSNR in order to enable transparent transmission with 400 Gbps over the same PP. Despite the additional power consumed by the new OAs, this solution can improve the overall EEPG of the network (i.e. reductions of 303.5 W in PC, and 200 GHz in spectrum occupancy are achieved). As a result, these new amplifier placements with EDFAs will be included in the final configuration of the network. It is worth noting that this example shows an extreme case (i.e. high traffic demand requiring several 400 Gbps TSPs and significant accumulated penalties over the path), where the deployment of four new OAs is justified from the EEPG point of view even to optimize a single LP. However, in most cases, the installation of additional OAs allows for optimizing more than a single LP, leading to more significant EEPG improvements.

6.5.4.1.2. Overall results

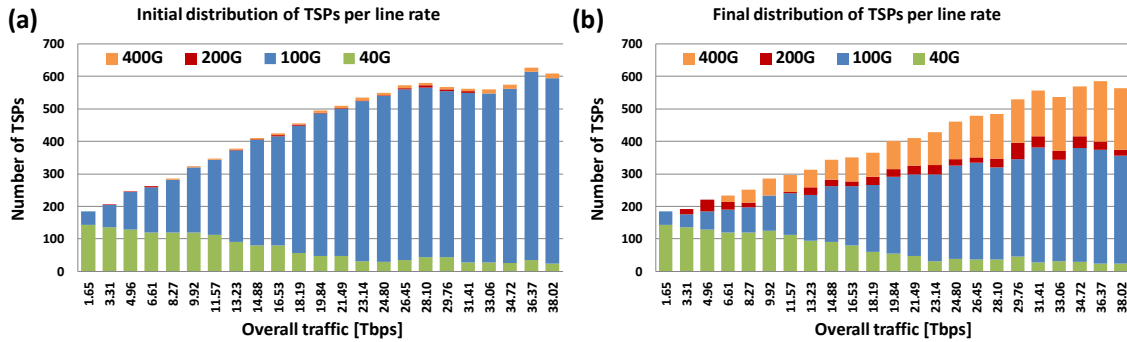

Figure 6.7. (a) Distribution of TSPs per line rate with the initial configuration of OAs; and (b) Distribution of TSPs per line rate after the additional EDFA placements.

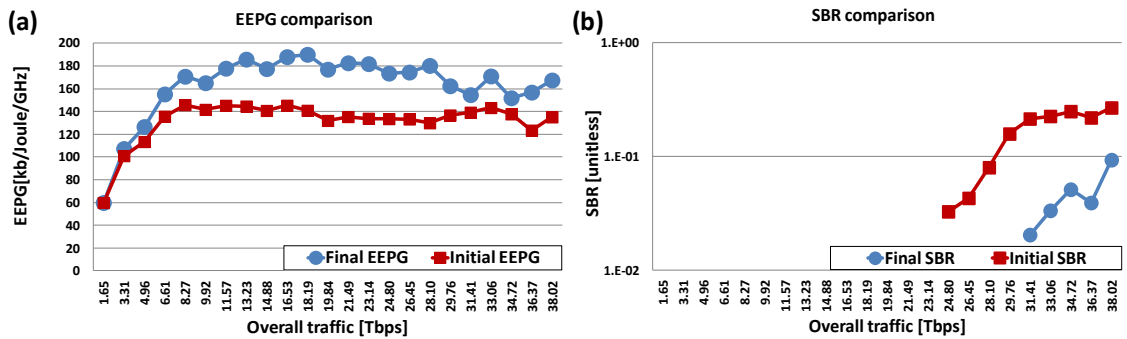

Figure 6.8. Comparison of the initial scenario (initial fixed-amplifier placements) and final scenario (after selectively placing additional in-line EDFAs) in terms of: (a) EEPG; and (b) SBR.

As shown in the previous case study, the placement of additional OAs is an effective method to increase the number of high-speed transmissions, which are more energy and spectral-efficient. The benefits of such an approach are more relevant at high traffic when the average traffic demand among nodes exceeds 100 Gbps. This section presents the results obtained after applying

the proposed algorithm to evaluate the selective placement of additional EDFAs in the network for the reference TM with different values of overall traffic.

Figure 6.7a and Figure 6.7b show the distribution of TSPs of each specific LR in the initial configuration of OAs and after the selective placement of additional EDFAs, respectively. As shown, the number of 400 Gbps TSPs can be significantly increased by selectively deploying additional EDFAs compared to the initial scenario, where 100 Gbps transmissions were predominant.

Figure 6.8a compares the initial and the final overall EEPG of the network. The main objective (i.e. improving the overall EEPG of the network) can be achieved by this strategy. As shown, the placement of additional EDFAs may result in noteworthy EEPG improvements with respect to the initial amplifier configuration (up to 27 percent). As mentioned earlier, the degree of improvements increases with transported traffic as TSPs providing higher throughput become more necessary (i.e. at low traffic, a large number of demands are provisioned with 40 Gbps and 100 Gbps TSPs whose OSNR requirements are often below the OSNR values at the link outputs in the evaluated network topology). However, when traffic is increased further, the spectrum occupancy starts to become significantly higher and LPs are routed over longer paths. For these high traffic demand values, due to the long paths, the deployment of additional OAs might not help providing sufficient OSNR improvements to enable the utilization of higher transmission rates. This can be noticed in the results of Figure 6.8a for overall traffic values over 18.19 Tbps, where the level of EEPG improvements compared to the initial configuration does not appreciably increase.

In addition to the desired energy efficiency improvements, the enhanced spectral efficiency also permits to allocate some of the initially blocked traffic demands and thus reduce the overall SBR of the network (Figure 6.8b), making it possible to convey more traffic in a single fiber-pair per link network (31.41 Tbps compared to 24.8 Tbps in the initial configuration). This would also bring advantages in terms of energy efficiency when considering, for example, the number of OAs that could be saved by using a smaller number of fibers. Moreover, the increased over-provisioned capacity at the TSPs enabled by the optimization could eventually be used if needed to cope with traffic increases, without requiring the establishment of new LPs. This would be beneficial from the energy efficiency point of view as well.

6.5.4.2. Additional hybrid Raman-EDFA (HRE)

6.5.4.2.1. Case study

Example: Traffic demand of 720 Gbps from F16-F17 with DP 1+1

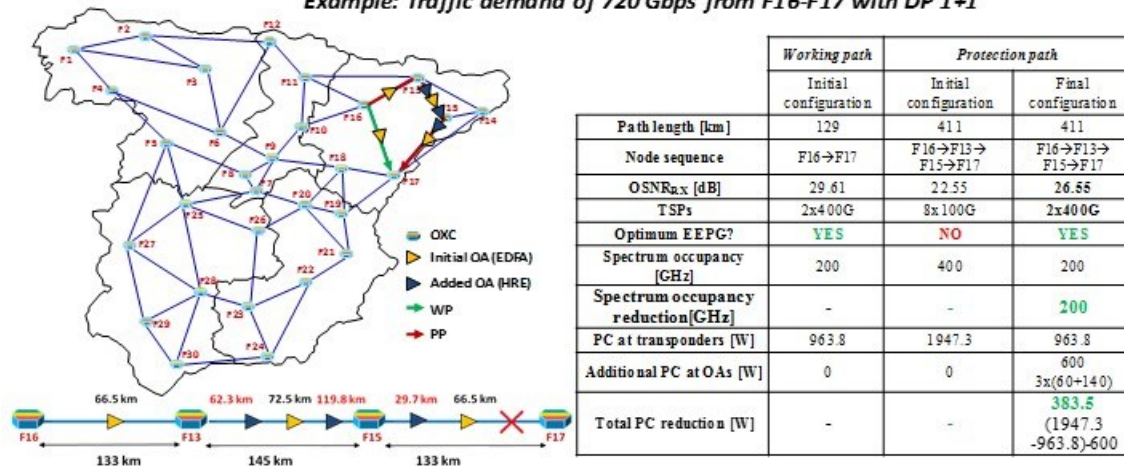

Figure 6.9. Case study with placement of additional HRE: Example of a traffic demand of 720 Gbps between nodes F16 and F17 with DP 1+1 before and after adding two HRE in link F13-F15 and one in F15-F17.

Figure 6.9 presents an example of EEPG improvements with the selective placement of additional HREs for a traffic demand of 720 Gbps between nodes F16 and F17. This example is similar to the one in Section 6.5.4.1.1, but in this case the optimization is carried out considering the selective placement of additional HREs instead of EDFAs. As can be noted, the OSNR for 400 Gbps transmissions can be sufficiently improved by placing three HRE (two in F13-F15 and one in F15-F17). This allows for the saving of one additional OA placement with respect to the EDFA case, where four additional EDFAs were needed. Accordingly, despite the higher energy consumed by this type of OA compared to EDFA, the PC can be further reduced by 383.5 W (compared to the 300 W of the optimization with EDFA in Figure 6.6). Overall, this case study gives an insight into the potential benefits that the lower *NF* of HRE can provide in terms of energy and spectral efficiency.

6.5.4.2.2. Overall results

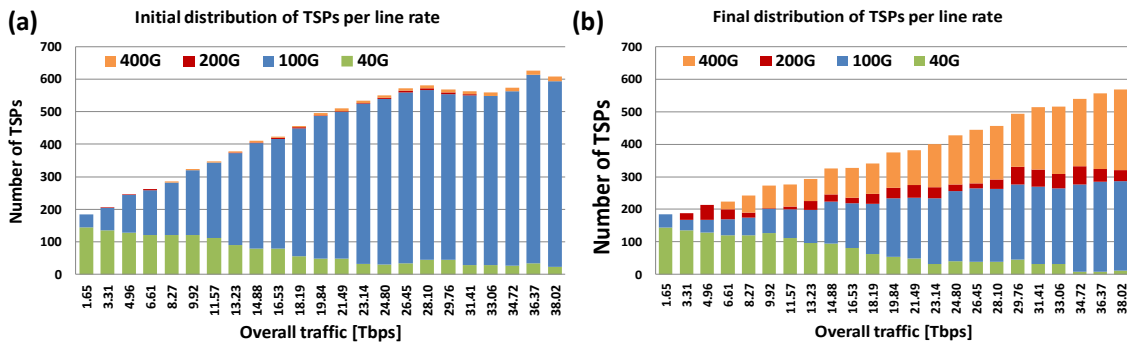

Figure 6.10. (a) Distribution of TSPs per line rate with the initial configuration of OAs; and (b) Distribution of TSPs per line rate after the additional HRE placements.

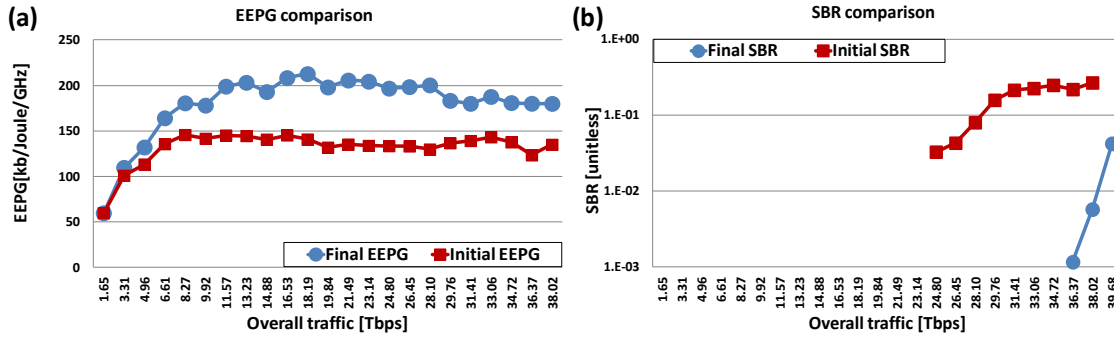

Figure 6.11. Comparison of the initial scenario (fixed-amplifier placements) and final scenario (after selectively placing additional in-line HREs) in terms of: (a) EEPG; and (b) SBR.

The selective placement of EDFAs at intermediate positions in the links was shown as an effective method to increase the number of high-speed transmissions with respect to the initial configuration of the network (Section 6.5.4.1.2). The deployment of additional HRE can further improve those results, enabling an even greater number of high-speed transmissions (Figure 6.10b) compared to the case with only EDFA (Figure 6.10a). This also results in significant EEPG improvements (up to 52 percent), as shown in Figure 6.11a. HRE, despite consuming more energy than traditional EDFA, can take relevant advantage of its low NF to optimize a larger number of LPs. This explains the superior performance of this optimization strategy with HRE to improve the overall EEPG of the network. The improvements are more remarkable at high traffic.

Moreover, the greater number of feasible 400 Gbps transmissions results in improved spectral efficiency, which permits to decrease the SBR values with respect to both the initial configuration of OAs (Figure 6.11b) and the optimization with EDFA only (Figure 6.8b). Consequently, the maximum traffic that a single fiber-pair per link network can support is increased to 34.72 Tbps with respect to the 31.41 and 24.8 Tbps achieved with the EDFA optimization and the initial configuration with fixed EDFA locations, respectively.

6.5.4.3. Network parameter sensitivity

This section aims at evaluating the influence of some parameters which may affect the effectiveness of the selective amplifier placement strategy.

6.5.4.3.1. Link ordering strategies for optimization

As explained in Section 6.5.3.2 and Algorithm 16, the optimization phase for the selective placement of additional OAs starts by sorting the links in *LinkList*. In the previous studies, the link ordering was done in descending order of the number of “NON-OPTIMIZED” LPs. However, in order to assess the potential influence of this ordering strategy on the results, a different ordering approach has been evaluated, which consists of ordering the links starting from the links containing the span with the highest losses (i.e. longest spans). The EEPG results obtained with both ordering strategies are shown in Figure 6.12 regarding both the selective placement of EDFAs and HREs. As can be seen, the results differ only slightly, suggesting that the link ordering strategy for optimization does not significantly affect the results as the iterative nature of the algorithm allows for evaluating many potential combinations of additional OA locations.

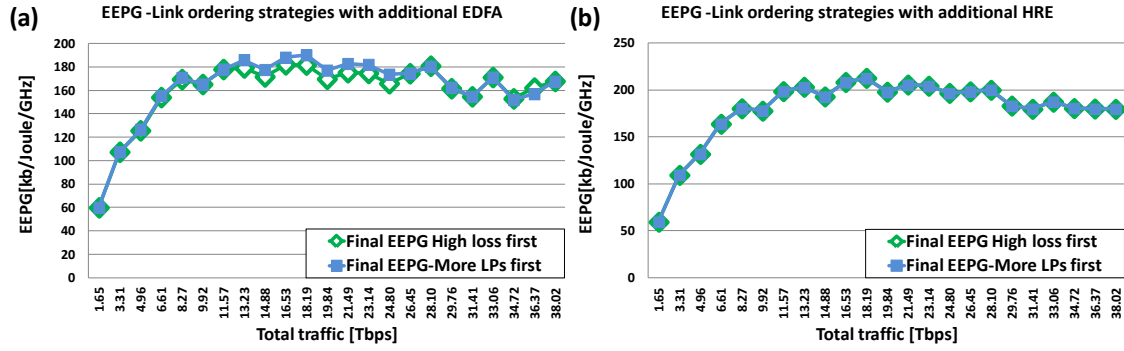

Figure 6.12. EEGP -Comparison of the two different link ordering strategies with selective placement of additional OAs: (a) EDFAs; and (b) HRE.

6.5.4.3.2. Power consumption of optical amplifiers

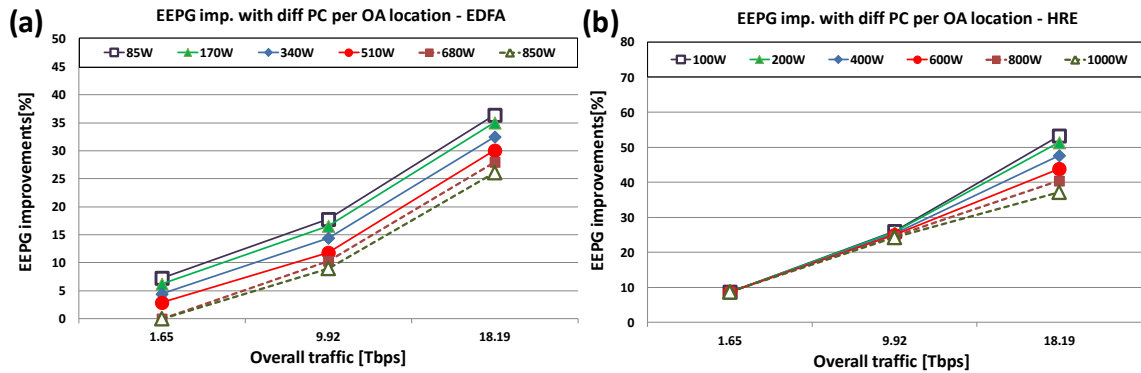

Figure 6.13. EEGP improvements achieved by the selective placement of additional OAs: (a) EDFAs; and (b) HRE.

A parameter sensitivity analysis of the PC of the additional OA placements has been performed in order to assess the influence of this parameter on the potential EEGP improvements. Note that just the PC of the new placements is varied, while the initial deployed placements (fixed ones) remain with the initial values (i.e. 30 and 60 W for EDFA and HRE cards, respectively). This analysis permits to evaluate a scenario where, for instance, additional PC contributions per amplifier location would be necessary when deploying new OA at new link sites (e.g. additional cooling).

For this purpose, the PC per additional amplifier location with different amplifier types has been varied in a range between 0.5 to 5 times the initially assumed values in Section 6.4.3.3 (i.e. 170 W for EDFA and 200 W for HRE, considering both the overhead and the OA card). The EEGP improvements with respect to the initial configuration of OAs are presented in Figure 6.13a and Figure 6.13b for EDFA and HRE, respectively. Clearly, the level of EEGP improvements is decreased if the PC assumed per amplifier location is increased. Moreover, the PC values also influence the number of cases where the placement of additional OAs is beneficial for improving the EEGP. Thus, at low traffic, as shown in Figure 6.13a, no additional OA would be placed if the PC of the new EDFA placements is too high. On the other hand, for the HRE case, its lower *NF* permits to improve the EEGP of the network in a similar manner at low traffic conditions even if the PC is higher. The differences in EEGP improvements are more noticeable at high traffic, where a larger number of additional OAs would be necessary to optimize the overall EEGP of the network.

Altogether, despite the different values of EEPG improvements, remarkable improvements can be achieved with respect to the initial scenario even in the most unfavorable scenario (when the OAs consume five times more power than the initially assumed values).

6.5.4.3.3. Power consumption of WDM transponders

TSPs are indeed the main contributors to the overall PC (especially at high traffic) in long-haul networks. Accordingly, a sensitivity analysis is carried out to study the influence on the final results of the PC values assumed for the TSPs. In particular, the PC values of the TSPs of 100, 200 and 400 Gbps have been varied in a certain range (i.e. the TSP of 100 Gbps from 75 to 300 percent, the TSP of 200 Gbps from 75 to 250 percent, and the 400 Gbps one from 50 to 250 percent), whereas that of 40 Gbps has been maintained with the initially assumed value (173.8 W). It is also assumed that TSPs with higher-speed consume more power than the lower-speed ones in each MLR scenario (e.g. 200 Gbps TSPs always consume more than a 100 Gbps). In fact, a very wide range of values have been evaluated (in the figures a selection of the most relevant combinations is shown) in order to assess the influence of this parameter and how the strategy of selectively placing additional OAs in the network can be affected by this parameter.

Figure 6.14a and Figure 6.14b show the EEPG of the network with different values of PC for the TSPs with the initial and final configuration of OAs (after selective placement of additional EDFAs), respectively. The percentage in the legend of the figures indicates the variation with respect to the initially assumed PC values for the TSPs of 100, 200 and 400 Gbps. As expected, increasing the PC of the TSPs with higher-speed has a negative impact on the overall EEPG values of the network. The difference is more distinguishable for high overall traffic values, since at low traffic a large number of LPs employ 40 Gbps TSPs, which were assumed to consume the same power in all scenarios (thus resulting in similar overall PC values). It is worth mentioning that the selection of TSPs to provision a particular traffic demand is also done according to the *EEPGMetric* in Eq. (2), so that the dimensioning of the network (*LRComb*) is affected by the PC values of the TSPs. In the initial scenario shown in Figure 6.14a, the LPs provisioned with TSPs of 100 Gbps are predominant (see Figure 6.7a) due to the granularity of the traffic demands and the physical transmission limitations (200 and 400 Gbps are feasible only for a limited number of LPs). Therefore, the PC value of a 100 Gbps is the most influencing parameter in terms of EEPG with the initial configuration of OA placements, and the other TSPs only slightly affect the results. As shown, in this case, the highest EEPG values are provided when the PC of 100 Gbps is lower than the original value (i.e. 75 percent of the initially assumed value).

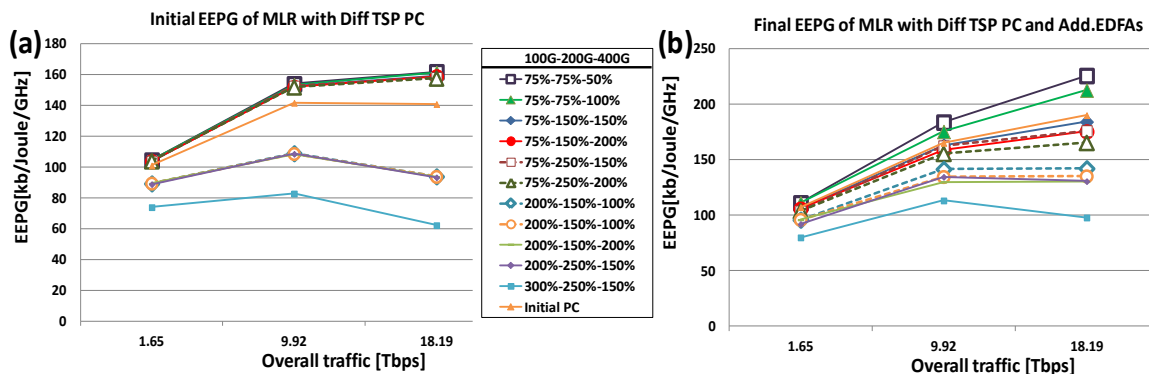

Figure 6.14. Parameter sensitivity results of the PC of WDM TSPs in a MLR (40/100/200/400 Gbps) network varying the PC of the TSPs of 100, 200 and 400 Gbps: (a) Initial EEPG; and (b) Final EEPG after selective placement of EDFAs.

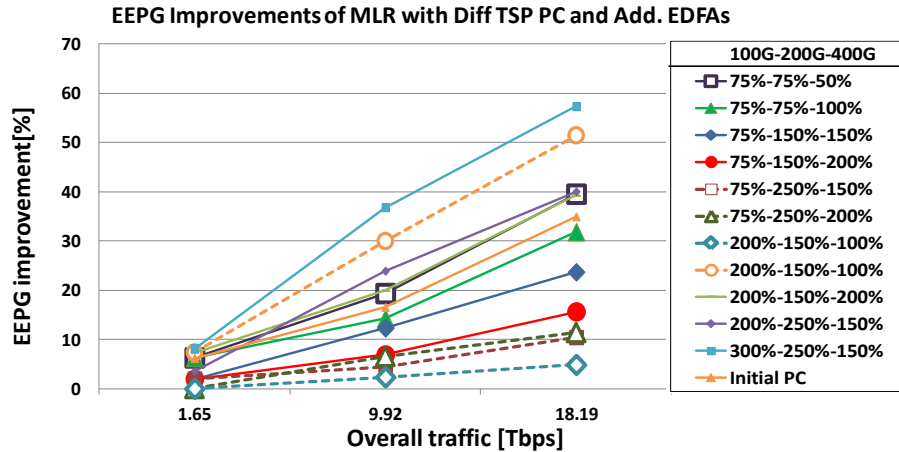

Figure 6.15. EEGP improvements - Parameter sensitivity of the PC of the WDM TSPs in a MLR (40/100/200/400 Gbps) network varying the PC of the TSPs of 100, 200 and 400 Gbps after the selective placement of EDFAs.

Figure 6.14b shows the EEGP after the selective placement of additional in-line OAs (EDFAs). In this case, more significant differences in terms of EEGP can be obtained when changing the PC values as not only the PC values of 100 Gbps TSPs, but also the ones of 200 and 400 Gbps have an impact on the results. As mentioned earlier, the placement of additional OAs indeed enables the deployment of a larger number of 200 and 400 Gbps connections. However, if the PC values of these two TSPs are significantly high (e.g. 250 and 150-200 percent for 200 Gbps and 400 Gbps, respectively), the employment of higher-speed TSPs would not bring considerable benefits in terms of energy efficiency (in many cases, it might be more efficient to employ 100 Gbps). Even in those unfavorable scenarios, the overall EEGP can nonetheless be improved, though to a more limited extent, by taking advantage of the enhanced spectral efficiency offered by the TSPs with higher throughput.

The EEGP improvements achieved by the selective placement of OAs over the initial amplifier locations are presented in Figure 6.15. The results show that this strategy can be promising to enhance EEGP regardless of the PC values of the TSPs. However, as stated before, the degree of improvements may significantly vary depending on the PC of the TSPs. In fact, the selective placement of additional OAs is especially beneficial in the scenarios which initially offered the worst EEGP results such as “300%-250%-150%” in Figure 6.14a. In this scenario, the placement of additional OAs can bring spectral efficiency benefits with almost negligible extra PC (i.e. PC values of OA, including overhead, are significantly lower than those of the TSPs). On the other hand, if 40 and 100 Gbps TSPs provide lower energy per bit per spectral unit than 200 and 400 Gbps TSPs (e.g. 75%-250%-200%), the selective placement of additional OAs would bring only little improvements.

6.5.5. Conclusions

The selective placement of additional in-line OAs can enable the realization of a larger number of high-speed connections to cope with the continuous traffic growth in an energy- and spectral-efficient manner.

The evaluated approach considers the reduction of the spacing between OAs (span length) by installing new OAs at intermediate link positions to improve the OSNR of high-speed transmissions. This can indeed increase the number of feasible transmissions with high-speed







TSPs in protected WDM MLR networks, resulting in network capacity enlargements and SBR reductions. The employment of TSPs requiring lower energy per bit per spectral unit eventually permits to achieve significant improvements in EEPG.

The strategy of selectively placing additional OAs was evaluated considering two types of OAs: EDFA and HRE. Despite the fact that EDFAs consume less power, placing additional HRE may result in higher EEPG improvements at high traffic loads thanks to its lower NF .

6.6. Energy-efficient amplifier strategies

6.6.1. Motivation and scope

Table 6.4. Amplification scenarios (AS).

Amplification scenario (AS)	OA type for the initial amplifier placements	OA type for the new intermediate amplifier placements	Link representation considering: 
<i>Init-EDFA</i>	EDFA	-	
<i>Init-EDFA & Upgrade</i>	Selective upgrade of EDFA to HRE to improve EEPG	-	
<i>Init-HRE</i>	HRE	-	
<i>Init-EDFA & Add EDFA</i>	EDFA	Selective placement of additional EDFA to improve EEPG	
<i>Init-EDFA & Add HRE</i>	EDFA	Selective placement of additional HRE to improve EEPG	
<i>Init-HRE & Add HRE</i>	HRE	Selective placement of additional HRE to improve EEPG	

The following amplification scenarios (AS) are considered and presented in Table 6.4: *Init-EDFA* (EDFAs deployed at the initial locations), *Init-EDFA & Upgrade* (EDFAs at the initial locations and selective upgrade of EDFAs to HREs to improve EEPG), *Init-HRE* (HRE at the initial locations), *Init-EDFA & Add EDFA* (EDFAs at the initial locations and selective placement of additional EDFAs to improve EEPG), *Init-EDFA & Add HRE* (EDFAs at the initial locations and selective placement of additional HRE to improve EEPG), *Init-HRE & Add HRE* (HREs at the initial locations and selective placement of additional HRE to improve EEPG).

6.6.2. Network parameters

6.6.2.1. Network architectures

WDM MLR with LRs of 40, 100, 200 and 400 Gbps are assumed as explained in Section 6.5.2.1.

6.6.2.2. Network operation modes

Conventional static operation is assumed.

6.6.2.3. Traffic conditions

The same traffic demand matrix of the TID network described in Section 6.5.2.3 is used for this evaluation.

6.6.3. Methodology

The RWA for MLR presented in Algorithm 14 is first carried out considering the initial type of OA under evaluation (deployed in fixed locations). After performing the RWA, another phase can be carried out (line 16 of Algorithm 14) to optimize the transmission of LPs for which the optimum *LRCOMB* could not be used due to insufficient OSNR levels at the receiver ($OSNR_{RX}$). In fact, two specific strategies can be adopted to improve the EEPG of the network by amplification strategies: (1) Selective placement of additional in-line OAs; (2) Selective upgrade of in-line EDFAs to HREs. After carrying out the optimization strategies, the performance measures such as the total EEPG and SBR are calculated again and compared with the initial results to determine the total improvement with respect to the initial situation (*Init-EDFA*).

6.6.3.1. Selective placement of additional in-line optical amplifiers

This process is described in Algorithm 16, taking into account whether EDFAs or HRE are used for the optimization.

6.6.3.2. Selective upgrade of EDFAs to HRE

The initially deployed EDFAs can be selectively upgraded to HRE by deploying a Raman module if this allows for improving the overall EEPG of the network. For this purpose, the in-line EDFAs placed in those links traversed by “NON-OPTIMIZED” LPs are evaluated for upgrade.

The process is described in Algorithm 17. As can be seen, it is similar to the selective placement of new OAs (Algorithm 16), but in this case, the already deployed fixed OAs in a specific link of *LinkList* (*NAmpLink*) can be evaluated for a potential upgrade. Thus, the potential upgrade is checked link-by-link to assess whether the lower noise provided by HRE with respect to EDFA will sufficiently improve $OSNR_{RX}$ to permit the transmission with the “optimum” *LRCOMB*. If the overall EEPG can be improved (by comparing the PC difference between the extra power consumed by HRE and the reduced PC at the TSPs, together with reduced spectral occupancy), the configuration of the network will be updated and the resource allocation changed accordingly. The upgrade can be evaluated from a single OA per link ($NAmp=1$) to the maximum number of initial OAs in the links (*NAmpLink*). When there is one more than one OA installed per link, the ones providing the highest OSNR improvements are selected first. Moreover, the simultaneous upgrade of EDFAs placed in different links (*NSimLinksToOptimize*) can be checked with an upper limit of four simultaneous links. Finally, the RWA (Algorithm 14) can be recomputed to check whether some of the blocked traffic demands can be allocated thanks to the spectral occupancy reduction.

Algorithm for the selective upgrade of existing EDFAs to HRE: Optimization phase

```

1. Sort links from LinkList in descending order of number of “NON-OPTIMIZED” LPs
2.  $NAmp \leftarrow 1$ 
3.  $NSimLinksToOptimize \leftarrow 1$ 
4. while ( $NSimLinksToOptimize \leq 4$ ) and (LinkList is not empty)
5.     while ( $NAmp \leq NAmpLink$ ) and (LinkList is not empty)
6.         for each link in ListOfLinks
7.             Upgrade  $NAmp$  OAs in the fixed amplifier location of the link
8.             for each “NON-OPTIMIZED” LP traversing the link
9.                 Re-compute OSNR for the end-to-end LP transmission with the “OPTIMUM” LRCComb
10.                Determine transparent reach possibility for LRCComb as in Eq. (24)
11.                if transparent reach
12.                    Store information about LP in UpdatedAllocation (Wavelength IDs, LRCComb)
13.                end if
14.            end for
15.        Compute potential EEPG improvements with UpdatedAllocation
16.        if EEPG improvement > 0
17.            Upgrade EDFAs to HREs
18.            Modify resource allocation according to UpdatedAllocation
19.            Delete optimized LPIDs from LinkList
20.            if no more LPs to optimize in Link
21.                Delete Link entry from LinkList
22.            end if
23.        end if
24.    end for
25.     $NAmp \leftarrow NAmp + 1$ 
26. end while
27.  $NSimLinksToOptimize \leftarrow NSimLinksToOptimize + 1$ 
28. end while
29. Re-run RWA in the updated physical topology (Algorithm 14)

```

Algorithm 17. Selective upgrade of the in-line deployed EDFA to HRE to improve EEPG.**6.6.4. Numerical results**

Different amplification scenarios (AS) are evaluated in terms of EEPG for the same network topology and traffic conditions. Figure 6.16 shows the potential EEPG improvements over the initial scenario where only EDFAs at fixed locations are deployed (*Init-EDFA*). The solutions based on the selective placement of additional OAs (*Init-EDFA & Add HRE*, *Init-EDFA & Add EDFA*, *Init-HRE & Add HRE*) show significant improvements in EEPG that could surpass 50 percent. The other AS that assume the upgrade of EDFAs to HRES did not shown relevant improvements. In fact, the selective upgrade of the existing OAs from EDFA to HRE (*Init-EDFA & Upgrade*) can slightly improve EEPG. However, upgrading all the initial EDFA to HRE (*Init-HRE*) may result in worse EEPG than the initial scenario at low traffic. Despite the fact that the OSNR level can be improved in this scenario, these improvements might not be enough to enable the use of higher-speed TSPs in many cases. Moreover, the slight potential energy efficiency improvements are rather cancelled by the higher power consumed by the HRE over EDFAs. However, this scenario can become energy-efficient when combined with the selective placement of additional in-line HRE (*Init-HRE & Add HRE*). It is worth mentioning than HRE are only considered to be placed in the links (in-line), while the pre-amplifiers and boosters are EDFAs.

Deploying higher speed TSPs enables an increase in spectral efficiency which results in capacity increases. In fact, the overall capacity of the network can be considerably increased with respect to the initial scenario (*Init-EDFA*), as shown in Figure 6.17a. This figure shows the overall traffic demand used as input in the TM in the x-axis, whereas the y-axis presents the total capacity provided by the summation of the throughput of all the deployed TSPs in the network. The largest capacity enhancements are provided by the solutions considering the selective placement of additional HRE (*Init-EDFA & Add HRE* and *Init-HRE & Add HRE*) that can nearly double the

maximum throughput of the network. *Init-EDFA & Add EDFA* also shows decent results in terms of increased capacity, though lower than the scenarios considering additional HRE placements. Finally, the AS that solely consider upgrading the currently deployed EDFAs to HREs can only slightly augment the capacity (increases below 5 percent).

The results showing the SBR of the different strategies are compared in Figure 6.17b. As can be noticed, the AS based on just upgrading the existing OAs to HRE (*Init-EDFA & Upgrade, Init HRE*) do not decrease the SBR with respect to the initial scenario. On the other hand, reducing the span length by placing additional OAs can considerably decrease SBR. In fact, SBR values can be especially decreased by selectively placing additional in-line HRE (*Init-EDFA & Add HRE* and *Init-HRE & Add HRE*).

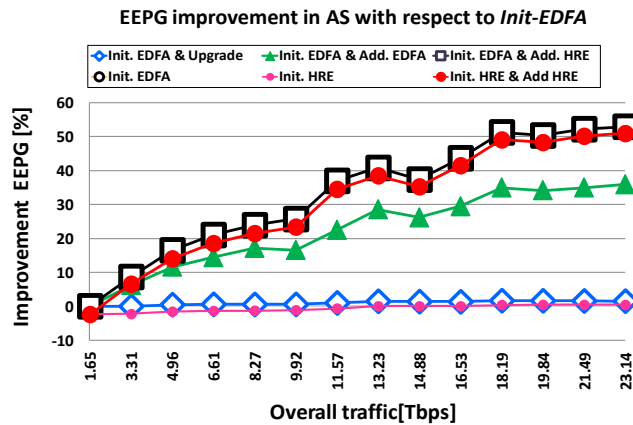

Figure 6.16. EEPG improvement of the evaluated AS with respect to the initial amplifier configuration (*Init-EDFA*) for results without blocking.

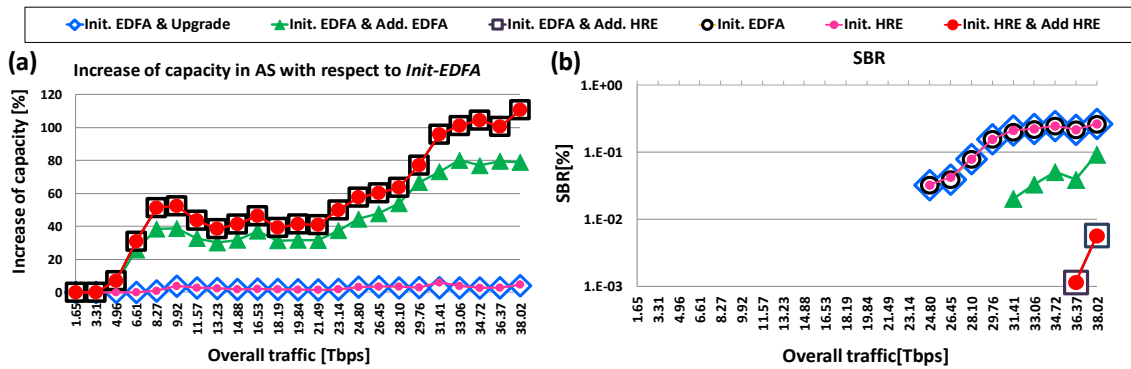

Figure 6.17. (a) Increase of network capacity of the evaluated AS with respect to the initial amplifier configuration (*Init-EDFA*) for results without blocking; and (b) SBR in the different AS.

6.6.5. Conclusions

New amplification strategies that consider the shortening of the amplifier spacing or the upgrade of deployed EDFAs to HRE can be key for the successful deployment of energy-efficient high-speed systems in future long-haul networks.

The performance of different amplification strategies was evaluated in a nation-wide network topology to assess the potential impact that they may have in terms of EEPG, network capacity increases and SBR. Among the different strategies, the selective placement of additional in-line

OAs was shown to be the most beneficial strategy to improve EEPG. The aforementioned approach is especially promising when HREs are deployed, which, despite consuming more power, offer higher potential to improve OSNR thanks to their lower NF compared to EDFAs. However, the strategy consisting of just upgrading the existing in-line OAs (from EDFA to HRE) was shown to provide little improvements in terms of EEPG and increased capacity.

6.7. Conclusions of the chapter

The envisioned traffic growth is forcing operators to find new approaches to achieve enhanced utilization of the spectrum and energy resources. The employment of more spectrally-efficient modulation formats in WDM networks (e.g. 200 or 400 Gbps) is not only convenient to enlarge the capacity of the network, but also to improve its energy efficiency as they have to operate with lower energy per bit. Nonetheless, the achievement of such large capacity may be limited by the physical impairments in long-haul networks (i.e. higher-speed TSPs are less tolerant to these effects).

OAs are key elements to enable the transmission over long distances, but they are commonly placed in spans of approximately 80 km from a network planning perspective. However, careful evaluation of the placement of OAs in the network can significantly improve network performance measures such as the overall throughput or the blocking ratios. In fact, with new amplification strategies, the number of feasible higher-speed transmissions can be increased, allowing for improved energy efficiency while reducing the spectral occupancy.

In this chapter, several amplification strategies have been proposed and evaluated with the final objective of improving the overall EEPG of the network. The deployment of additional OAs at intermediate positions in the spans is the approach which shows the most remarkable performance improvement in terms of EEPG and increased capacity. Regarding new amplification techniques, HRE can offer promising advantages with respect to the conventional EDFAs thanks to its lower NF . Still, only the migration of current in-line EDFA to HRE might not bring significant improvements in terms of EEPG or capacity increases. It consumes more power than EDFA and has different characteristics that may require it to be placed at different locations to fully exploit their potential. Nevertheless, the selective placement of additional HRE at intermediate positions in the links was shown as the most effective mechanism to improve the EEPG (up to 52 percent) and nearly double the overall throughput in the evaluated network scenario. Similar results can be expected in different long-haul networks, but the degree of improvement may vary according to the traffic pattern (e.g. average traffic demand) and network topology characteristics (e.g. distance between nodes exchanging information, average number of traversed nodes, etc.).

In summary, new amplification types and amplifier placement strategies will be helpful to enable higher-speed transmissions in long-haul networks. The promising advantages in terms of EEPG enhancements and capacity augments can definitely help to convince operators to consider new amplification deployment strategies when designing the networks.

Furthermore, it is worth mentioning that DP 1+1 has been considered in this study since it is the most widely deployed protection scheme today, but further EEPG improvements may be obtained when combining these novel amplification strategies with more flexible protection schemes such as the options studied in Chapter 5. Future work may also consider studying new amplification strategies for EON architectures, where improvements of the signal quality may enable the transmission with higher-order modulation formats (Chapter 4).

To complete this chapter, an overview of the main findings is presented in Table 6.5.

Table 6.5. Overview of findings in Chapter 6.

Topic	Findings	Section
<i>Amplifier placement strategies</i>		
Selective placement of additional OAs	Significant improvements in terms of EEPG with respect to a typical deployment scenario can be achieved. Spectral efficiency enhancements also permit to reduce SBR and thus increase the overall capacity of the network.	6.5.4.1 and 6.6.4
Selective upgrade of EDFAs to HRE	Upgrading existing in-line locations from EDFA to HRE only provides slight improvements in terms of EEPG and increased capacity.	6.6.4
The selective placement of additional OAs is a promising strategy to enable high-speed transmissions and improve the energy and spectral efficiency of the networks		
<i>Amplifier type</i>		
HRE vs. EDFA	The low NF provided by HRE with respect to EDFA enables more high-speed transmissions when selectively placed in the links of the network. This brings further increases in terms of EEPG and capacity. Only upgrades of in-line OAs from EDFA to HRE may bring only little benefits.	6.5.4.2 and 6.6.4
HRE may play important roles to optimize the energy and spectral efficiency of future optical transport networks		
<i>Other findings</i>		
Sensitivity to PC of additional OAs placements	The increase in terms of PC at the links due to the deployment of extra OAs can be extensively overcome by the potential EEPG improvements brought by higher-speed transmissions (even if the OAs consume significantly more power).	6.5.4.3
Sensitivity to PC of TSPs	The selective placement of OAs can generally bring EEPG improvements for increased values of traffic load regardless the assumed PC figures of the TSPs.	6.5.4.3
Novel amplifier placement strategies and low-noise OAs may bring significant EEPG improvements and increased capacity to future networks		

CHAPTER 7. SUMMARY AND CONCLUSIONS

The focus of this dissertation was set on improving the energy efficiency of optical transport networks by adopting new design approaches for network architectures, different operation modes, novel protection techniques and innovative amplification strategies. This chapter summarizes the main contributions and provides directions for future work.

7.1. Summary of the main contributions and conclusions

Optical transport networks have to cope with increased traffic values in an energy-efficient manner while maintaining high service availability. This thesis contributes to this goal by proposing and evaluating different methods which exploit some of the inefficiencies incurred in the conventional design tasks and operation modes to enhance the energy efficiency of optical transport networks. More specifically, the main contributions of this thesis are summarized in the following paragraphs for the different network design areas:

- **Flexible network architectures:** More flexible network architectures are necessary to support the traffic growth in an energy- and spectral-efficient manner. The simulation results indicate that a move from networks with fixed-grid towards networks with flexible-grid can be beneficial to improve spectral efficiency and transmit more traffic per fiber regardless of the type of TSP being used. The improvement in spectral efficiency also translates into energy efficiency enhancements as the number of energy-consuming network elements to be deployed is reduced. On the other hand, the adaptive line rate functionality can provide a finer adjustment of the capacity to the traffic demand compared to the conventional fixed-rate approaches. The results show that this functionality can clearly enhance the overall energy efficiency of the network (especially at high traffic loads) even if the fixed channel spacing configuration is maintained. In fact, the EON architecture which operates with adaptive line rate (by BVTs) and a flexible-grid frequency plan (enabled by BV-OXC deployments) is shown as the most promising solution to enhance both the energy and spectral efficiency of future optical transport networks, clearly outperforming the conventional ITU-T fixed-grid architectures with fixed-rate TSPs.
- **Dynamic operation of the optical layer:** Optical transport networks are operated in a static manner and commonly considered as coarse traffic pipes which are always available to handle any kind of service. Moreover, since resources are over-provisioned to support unexpected traffic increases, constant power is consumed by the equipment regardless of the actual useful data, which might be much lower than the provisioned capacity. Accordingly, dynamically adjusting the transmission to traffic fluctuations seems to be effective to improve the resource utilization in future networks. The simulation results show that significant energy can be saved by assuming semi-static operation with the proposed TAPA scheme, which considers the temporary deactivation of some TSPs during low-traffic periods (e.g. at night). In a more disruptive scenario, the operation of the optical layer can be considered as fully dynamic (i.e. BoD services). In this scenario, the simulation results also demonstrate that EON architectures with adaptive line rate operation and flexible-grid are not only the most energy-efficient, but also provide much lower network blocking than fixed-grid WDM architectures.

- **Energy efficiency of conventional protection schemes:** Ensuring high service availability is a must for operators. Common approaches rely on provisioning redundant network resources to be used in case of failures. In particular, DP 1+1 is currently the most widely adopted scheme to protect the traffic in the network. Nevertheless, it is demonstrated by simulations that DP 1+1 offers poor EEPG compared to more flexible schemes such as DP 1:1 and SP. In particular, SP, which is based on sharing spectral resources to protect different connections, does not only offer enhanced EEPG levels, but also permits to carry more traffic per fiber. However, the longer RT of SP makes it not suitable for some particular services/users with strict requirements in terms of service availability.
- **Novel energy-efficient protection schemes:** In spite of its poor EEPG, operators are reluctant to replace DP 1+1 due to its higher reliability and simplicity over other protection schemes. In this dissertation, novel schemes are proposed to improve the energy efficiency without sacrificing the high availability levels provided by DP 1+1. These schemes could be eventually applied by operators in their networks in the near future. A variation of DP 1+1 (DP TAPA) is first proposed to exploit the daily traffic patterns in order to reduce the energy consumption of the protection resources, while the transmission on the WPs remains unmodified. In this manner, the reliability of DP 1+1 can be maintained as the transmission over the PP remains active (though with reduced throughput) and can be used in case of failure. The simulation results of such a scheme in nation-wide network topologies show that noteworthy energy savings can be achieved in both conventional WDM networks and EON architectures, especially when the average traffic grows and during the moments where the demand is much lower than the peak value (e.g. at night and weekends).

A second approach to overcome the inefficient resource utilization of DP 1+1 relies on differentiating the traffic according to the protection requirements, assuming that not all the services/users need the high availability provided by DP 1+1. In fact, DP 1+1 is often applied to all traffic without considering the specific nature and requirements of the services. A Diff QoP scheme permits it to match the protection requirements to the heterogeneous service/user requirements. The results show that Diff QoP can indeed offer relevant energy and spectrum savings over the conventional DP 1+1 for static and dynamic scenarios in both fixed-grid WDM and EON architectures. The benefits of such scheme are more relevant at high traffic and in traffic scenarios where the protection requirements of the services are generally more relaxed.
- **Energy-efficient placement of additional OAs:** While OAs are key elements to realize transmissions over long distances, from a network planning perspective, they are mainly considered as elements deployed at almost fixed distances along the links. Higher-speed communications systems beyond 100 Gbps (e.g. 200 and 400 Gbps) are envisioned to cope with the dramatic traffic growth in an energy- and spectral-efficient manner (i.e. higher-speed systems commonly require lower energy per bit per spectral unit). However, the potential capacity augments enabled by these new systems may be limited by the physical impairments from source to destination nodes in long-haul networks. In this thesis, the selective placement of additional in-line OAs was proposed to improve the signal quality (OSNR levels) of high-speed LPs and thus improve EEPG. The simulation results demonstrate that by increasing the number of high-speed transmission, the overall EEPG and capacity of a nation-wide WDM network with MLR can be significantly enhanced. This strategy is especially advantageous when traffic load increases and higher-speed TSPs become the most convenient choices in terms of EEPG to provision the services (i.e. when the average demands are greater than 100 Gbps).

- **Advanced amplification strategies:** EDFA is the most commonly used amplifier type in optical transport networks. Despite its numerous advantages, an EDFA inserts noise which deteriorates the signal and eventually reduces the transmission distance. Though the noise levels do not generally entail a significant drawback in current networks based on transmission rates below 100 Gbps, they may limit the application of new transmission systems that require higher OSNR levels. Therefore, low-noise OAs may help extending the transmission reach of the new optical transmission generations. In this regard, HRE can play an important role thanks to its low NF . Part of the investigation carried out in this thesis is focused on comparing the performance of HRE and EDFA in different scenarios. Despite consuming more power than EDFAs, the simulation results show that the selective placement of additional HRE in the links can considerably enhance the EEPG and increase the overall capacity of the network with respect to conventional EDFA deployments. However, only upgrading the existing in-line EDFA to HRE might not provide sufficient OSNR improvements to realize a larger number of higher-speed connections and improve the EEPG of the network.

7.2. Future research challenges

The work presented in this thesis attempted to address the rising energy consumption problem in optical transport networks by proposing and evaluating different approaches. Nevertheless, there is still significant work to complete in this area with the ultimate objective of achieving an energy-efficient network in the future. In fact, the work carried out during this thesis opened some new directions for research that could be interesting to explore:

- **EON paradigm:** As discussed in Chapter 4, the EON paradigm offers enormous potentials to improve the energy efficiency of the network and to make the resource allocation more flexible. However, there is still significant research to be done at different levels. At the node level, BVTs with adaptive transmission capabilities both at the line and client sides need to be developed considering the energy efficiency implications as well (e.g. enabling partial deactivation of some subcarriers and “on-the-fly” modulation format changes to reduce PC). At the network level, almost “hitless” defragmentation techniques would be necessary when assuming dynamic operation in order to simplify the spectrum management and reduce blocking (and thus the number of employed fibers). The development of an intelligent control plane would also be required to fully exploit the potentials of EON, taking the energy consumption issues into account. In this regard, it would also be interesting to monitor how much power will be consumed by the control plane tasks. Furthermore, new physical layer modeling techniques that are different from the ones considered for fixed-grid networks might be needed as well, especially for dynamically operated networks.
- **Resilience schemes:** Improved multi-layer interaction would be desired to make the optical layer aware of the reliability and availability requirements of the services and applications running on top of it. An intelligent control plane that is aware of these requirements would facilitate the application of the Diff QoP concept to reduce energy consumption. Some other interesting directions for future work can exploit the combination of restoration and protection schemes, so that the amount of redundant dedicated resources (and thus the power consumed for protection purposes) can be reduced. Moreover, the potential advantages brought by the adaptive modulation format

and elastic bandwidth transmission of EON architectures could be exploited in different manners by novel protection schemes to improve the overall energy consumption.

- **Amplification strategies:** The evaluation of amplification scenarios carried out in this dissertation assumed an existing network where in-line OAs were already deployed at given locations. However, it would be interesting to design a network from scratch or completely re-design the network to select the most efficient locations to place OAs (both EDFA and HRE) with the ultimate objective of improving the overall energy and spectral efficiency. Moreover, the different amplification strategies were evaluated in this thesis for WDM MLR architectures with DP 1+1. It would be interesting to evaluate the overall energy benefits of such amplification solutions with more energy-efficient network architectures such as EON, and adopting novel energy-efficient protection schemes like DP TAPA or Diff QoP.
- **Implementability in real networks:** The potential advantages of the different approaches evaluated in this thesis have been assessed by simulations. However, it would be required to test the potential advantages in real deployment scenarios by considering the implementability issues that may arise as well. Moreover, cost implications also have to be carefully evaluated. Reducing energy consumption will certainly reduce part of the OpEx, but some energy-aware approaches may rely on novel equipment which could be initially expensive and have a considerable impact in terms of CapEx. Accordingly, it is necessary for operators to investigate the overall cost advantages to assess the successful applicability of the energy-aware techniques.
- **Carbon footprint reduction:** Although the reduction of GHG emissions is implicitly taken into account by the proposed energy-aware approaches, more specific work can be done to face this challenge. For instance, considering the utilization of renewable energy sources at some equipment locations (nodes and links).

LIST OF PUBLICATIONS

The work presented in this thesis has been partly published in the proceedings of International conferences and journals. The following list gives an overview of the related publications in chronological order:

1. J. López, Y. Ye, V. López, F. Jiménez, R. Duque, P. Krummrich, "On the Energy Efficiency of Survivable Optical Transport Networks with Flexible-grid," *European Conference and Exhibition on Optical Communications (ECOC)*, Sep. 2012.
2. J. López, Y. Ye, V. López, F. Jiménez, R. Duque, P. Krummrich, F. Musumeci, M. Tornatore, and A. Pattavina, "Traffic and Power-Aware Protection Scheme in Elastic Optical Networks," *XVth International Telecommunications Network Strategy and Planning Symposium (NETWORKS)*, vol., no., pp.1,6, 15-18 Oct. 2012.
3. J. López Vizcaíno, Y. Ye, V. López, F. Jiménez, R. Duque, P. Krummrich, "Cost Evaluation for Flexible-Grid Optical Networks," *IEEE Global Telecommunications Conference (GLOBECOM) Workshops*, vol., no., pp.358,363, Dec. 2012.
4. J. López Vizcaíno, Y. Ye, F. Jimenez, R. Duque, F. Musumeci, M. Tornatore, P.M. Krummrich, A. Pattavina, "Quality of protection schemes with extended flexibility for improved energy efficiency in transport networks," *9th International Conference on the Design of Reliable Communication Networks (DRCN)*, vol., no., pp.28,35, Mar. 2013.
5. J. López Vizcaíno, Y. Ye, V. Lopez, F. Jimenez, R. Duque, F. Musumeci, A. Pattavina, and P. Krummrich, "Differentiated Quality of Protection to Improve Energy Efficiency of Survivable Optical Transport Networks," *Optical Fiber Communication Conference/National Fiber Optic Engineers Conference (OFC/NFOEC)*, pp. OM3A.1. Mar. 2013.
6. J. López Vizcaíno, P. Soto, Y. Ye, F. Jimenez, P. Krummrich, "Energy-efficient and Low Blocking Probability Differentiated Quality of Protection Scheme for Dynamic Elastic Optical Networks," *21st International Conference on Software, Telecommunications and Computer Networks (SoftCOM)*, vol., no., pp.1,5, Sep. 2013.
7. J. López Vizcaíno, Y. Ye, F. Jiménez, P. Krummrich, "Energy- and Cost-Efficient Protection in Core Networks by a Differentiated Quality of Protection Scheme," *European Conference on Optical Communications (ECOC)*, Sep. 2013.
8. J. López Vizcaíno, Y. Ye, V. López, F. Jiménez, R. Duque, I. Tafur Monroy, Peter M. Krummrich, "Green Networking and Communications: ICT for Sustainability," *Chapter 17-Energy Efficiency Improvement with the Innovative Flexible-grid Optical Transport Network*, Auerbach Publications- CRC Press, Taylor & Francis Group, ISBN: 978-1-4665-6874-7, Nov. 2013.
9. J. López Vizcaíno, Y. Ye, V. López, F. Jiménez, F. Musumeci, M. Tornatore, A. Pattavina, P. M. Krummrich. "Protection in optical transport networks with fixed and flexible grid: Cost and energy efficiency evaluation," *Optical Switching and Networking*, vol. 11, pp 55-71, Jan. 2014.
10. J. López Vizcaíno, Y. Ye, F. Jiménez, A. Macho, P. Krummrich, "Optimized Amplifier Placements for Improved Energy and Spectral Efficiency in Protected Mixed-Line-Rate Networks," *Optical Fiber Communication Conference (OFC)*, pp. Th1E-5, Mar. 2014.
11. J. López Vizcaíno, Y. Ye, F. Jiménez, P. M. Krummrich. "Amplifier placements optimization for enhanced energy efficiency in optical transport networks," *IEEE International Conference on Communications (ICC)*, 2014, pp. 3700-3706, Jun. 2014.
12. J. López Vizcaíno, Y. Ye, F. Jiménez, A. Macho, P. Krummrich, "Increased energy efficiency and capacity for mixed-line-rate WDM networks with hybrid Raman-EDFA amplification," *European Conference on Optical Communication (ECOC)*, pp. 1-3, Sep. 2014.
13. J. López Vizcaíno, P. Soto, Y. Ye, P. M. Krummrich, "Differentiated quality of protection: An energy-and spectral-efficient resilience scheme for survivable static and dynamic optical transport networks with fixed-and flexible-grid," *Optical Switching and Networking*, vol. 19, Part 2, pp 78-96, 2016.
14. J. López Vizcaíno, Y. Ye, V. López, P. Krummrich, "Cost Evaluation of Amplification Strategies for WDM Mixed-Line-Rate Networks," *International Conference on Transparent Optical Networks (ICTON)*, July 2015.

LIST OF ACRONYMS

ADSL	Advanced Digital Subscriber Line	NF	Noise Figure
AMC	Adaptive Modulation and Coding	NZDSF	Non-Zero Dispersion Shifted Fiber
APS	Automated Protection Switching	OA	Optical Amplifier
ASE	Amplified Spontaneous Emission	OBS	Optical Burst Switching
BER	Bit Error Ratio	OCS	Optical Circuit Switching
BoD	Bandwidth on Demand	ODF	Optical Distribution Frame
BPSK	Binary Phase Shift Keying	ODU	Optical Data Unit
BV-OXC	Bandwidth-Variable OXC	OEO	Optical-Electrical-Optical
BVT	Bandwidth-Variable Transponder	OFDM	Orthogonal Frequency Division Multiplexing
CAPEX	Capital Expenditures	OOK	On-Off Keying
CDC	Colorless, Directionless and Contentionless	OPEX	Operational Expenditures
CMOS	Complementary Metal–Oxide–Semiconductor	OPS	Optical Packet Switching
CO-OFDM	Coherent Optical OFDM	OSI	Open Systems Interconnection
CW	Continuous Wave	OSNR	Optical Signal-to-Noise Ratio
CWDM	Coarse WDM	OTN	Optical Transport Network
DAC	Digital to Analog Converter	O-VPN	Optical Virtual Private Networks
DEE	Dynamic Energy Efficiency	OXC	Optical Cross Connect
DEEI	Dynamic Energy Efficiency Improvement	PC	Power Consumption
DEMUX	De-multiplexer	PCE	Path Computation Element
Diff-QoP	Differentiated Quality of Protection	PD	Propagation Delay
DiR	Differentiated Reliability	PDL	Polarization-Dependent Loss
DLP	Dedicated Link Protection	PDM	Polarization Division Multiplexing
DP	Dedicated Protection	PIC	Photonic Integrated Circuit
DP 1:1	Dedicated Protection 1:1	PMD	Polarization-Mode Dispersion
DP 1+1	Dedicated Protection 1+1	PON	Passive Optical Network
DPP	Dedicated Path Protection	PP	Protection Path
DP-16QAM	Dual-Polarization 16QAM	PSK	Phase Shift Keying
DP-QPSK	Dual-Polarization QPSK	PUE	Power Usage Effectiveness
DP TAPA	Dedicated Protection Traffic-Aware Power-Aware	QAM	Quadrature Amplitude Modulation
DQPSK	Differential Quadrature Phase Shift Keying	QoP	Quality of Protection
DRA	Distributed Raman Amplification	QoS	Quality of Service
DSBR	Dynamic Service Blocking Ratio	QoT	Quality of Transmission
DSF	Dispersion Shifted Fiber	QPSK	Quadrature Phase Shift Keying
DSP	Digital Signal Processing	REG	Regenerator
DT	Deutsche Telekom	RMLSA	Routing, Modulation Level and Spectrum Allocation
DWDM	Dense WDM	ROADM	Reconfigurable Optical Add/Drop Multiplexer

EA-RMLSA	Energy-Aware-Routing, Modulation Level, and Spectrum Allocation	ROSNR	Required OSNR
EA-RWA	Energy-Aware-Routing and Wavelength Assignment	RP	Regenerator Placement
EASPP	Energy-Aware Shared Path Protection	RSA	Routing and Spectrum Allocation
EDF	Erbium-doped Fiber	RT	Recovery Time
EDFA	Erbium-doped Fiber Amplifier	RWA	Routing and Wavelength Assignment
EE	Energy Efficiency	RX	Receiver
E EI	Energy Efficiency Improvement	SBR	Service Blocking Ratio
EEPG	Energy Efficiency per GHz	SDH	Synchronous Digital Hierarchy
EON	Elastic Optical Networks	SDM	Space Division Multiplexing
FD	Failure Detection time	SDN	Software-Defined Network
FEC	Forward Error Correction	SEI	Spectral Efficiency Improvement
FF	First-fit	SiP	Silicon Photonics
FS	Frequency Slot	SLA	Service Level Agreement
FTTH	Fiber to The Home	SLP	Shared Link Protection
FWM	Four Wave Mixing	SLR	Single Line Rate
GB	Guard Band	SMF	Single Mode Fiber
GbE	Gigabit Ethernet	SO	Spectral Occupancy
GeSI	Global e-Sustainable Initiative	SP	Shared Protection
GHG	Greenhouse gas	SPM	Self-phase Modulation
GMPLS	Generalized Multi-Protocol Label Switching	SPP	Shared Path Protection
HRE	Hybrid Raman-EDFA	SRG	Shared Risk Group
ICT	Information and Communication Technology	SRS	Stimulated Raman Scattering
IP	Internet Protocol	TAPA	Traffic-aware and Power-aware
ISP	Internet Service Provider	TID	Telefónica I+D
ITU	International Telecommunications Union	TO	Time setup cross connection at OXC
ITU-T	International Telecommunications Union-Telecommunication	TR	Transmission Rate
KSP	K-Shortest Paths	TS	Traffic Scenarios
LP	Lightpath	TSPs	Transponders
LR	Line Rate	TX	Transmitter
LTE	Long-Term Evolution	UMTS	Universal Mobile Telecommunications System
LWPF	Low Water Peak Fiber	VLAN	Virtual Local Area Network
MCS	Multicast Switch	WA	Wavelength Assignment
MF	Modulation Format	WDM	Wavelength Division Multiplexing
MILP	Mixed Integer Linear Programming	WP	Working Path
MLR	Mixed Line Rate	WSON	Wavelength Switched Optical Networks
MMF	Multi-Mode Fiber	WSS	Wavelength Selective Switch
MP	Message Processing time	XPM	Cross-Phase Modulation
MUX	Multiplexer		

LIST OF SYMBOLS

Notation	Description	Units
$10G\lambda_s$	Number of 10 Gbps WDM TSPs in WDM MLR architectures	N/A
$40G\lambda_s$	Number of 40 Gbps WDM TSPs in WDM MLR architectures	N/A
$100G\lambda_s$	Number of 100 Gbps WDM TSPs in WDM MLR architectures	N/A
a	Add/Drop degree	N/A
α	Fiber attenuation factor	dB/km
Aggregated P_{RX}	Total aggregated power obtained at the RX	dBm
ASpE	Average spectral efficiency in the links of the network	bits/Hz
AvgSO	Average spectral occupancy in the links of the network	GHz
BlockedTraffic	Summation of the TR of all the blocked demands in the network	Gbps
B_r	Resolution bandwidth for OSNR measure	Hz
BWCBand	Entire useful bandwidth in the ITU-T C band, i.e. 4 THz	THz
ChannelSpacing	Chosen ITU-T grid in WDM architectures	GHz
currentTrafficDemand	Traffic demand value at a specific time (considering traffic variations)	Gbps
D	Diameter of the network topology	km
DataFlow	Data transmitted in the duration of the flow	bits
DEE	Energy efficiency in the dynamic scenario considering the data transmitted and the energy consumed	bits/Joule
DEEI	Energy efficiency improvements of Diff QoP with respect to DP 1+1 in a dynamic scenario	percent
DemandIndex	Index used to select the traffic demand in <i>ListOfDemands</i>	N/A
DSBR	Service blocking ratio measures to indicate the percentage of data that could not be allocated in the network with respect to the total data in the dynamic scenario	percent
ECFlow	Energy consumed during the transmission of a particular flow	Joules
EC_{OA}	Energy consumed by an OA in the simulated time	Joules
EC_{OXC}	Energy consumed by an OXC in the simulated time	Joules
EE	Overall Energy Efficiency in the network considering the total carried traffic demands and the PC of all the network elements	bits/Joule
EEl	Energy efficiency improvements of Diff QoP with respect to DP 1+1	percent
EEPath	Energy efficiency of a LP	bits/Joule
EEPG	Overall Energy Efficiency per GHz in the network considering the total carried traffic, the PC of all the network elements and the average spectral occupancy in the links of the network	bits/Joule/GHz
EEPGMetric	Energy efficiency per GHz metric used to determine the most energy- and spectral-efficient transmission for a LP	bits/Joule/GHz
f	Frequency	Hz
Fcap	Flow request value	bps
FD	Time to detect a failure	s
FDur	Time duration of a flow	s
FS	Frequency slot size in flexible-grid architectures	GHz
FStTime	Starting time of a flow in the dynamic scenario	s
FTC	QoP traffic class of a flow	N/A
G	Optical amplifier gain	dB
GB	Guard band	N/A
HighestEEPGMetric	Variable to store the highest EEPG metric obtained for a LP transmission	bits/Joule/GHz
HighestEEPGMetricPP	Variable to store the highest EEPG metric obtained for a LP transmission in the PP	bits/Joule/GHz

<i>HighestEEPGMetricWP</i>	Variable to store the highest EEPG metric obtained for a LP transmission in the WP	bits/Joule/GHz
λ	Arrival rate in dynamic scenario	Num. of new requests/time unit
<i>L</i>	Span length	km
<i>Li</i>	Number of bidirectional links	N/A
<i>LinkExists</i>	Variable that determines whether there are LPs not using the optimum <i>LRComb</i> in <i>LinkList</i>	N/A
<i>LinkList</i>	List which contains the links that are traversed by LPs not using the optimum <i>LRComb</i> in terms of EEPG	N/A
<i>ListOfDemands</i>	List which contains the information of the traffic demands, i.e. source node, destination node, and demand value	N/A
<i>ListOfPaths</i>	List which contains the information regarding the KSP from source to destination nodes, i.e. link and node sequences, total length	N/A
<i>ListOfProtectPaths</i>	List which contains the information about possible PPs for each WP in DP, i.e., node sequence, link sequence, and path length	N/A
<i>ListOfWorkingPaths</i>	List which contains the information about possible WPs in DP, i.e., node sequence, link sequence, and path length	N/A
<i>ListUnprotected</i>	List which contains all the LPs that cannot be protected with SP	N/A
<i>LpCandIndex</i>	Index used to select the LP to perform grooming among the possible candidates in <i>ListOfPaths</i>	N/A
<i>LPGroomingList</i>	List of LPs candidate for grooming of a demand, i.e. sharing the same source and destination nodes	
<i>LPTC</i>	QoS traffic class of the LP	N/A
<i>LRComb</i>	Line rate combination, i.e. combination of TSPs used to serve a traffic demand in WDM MLR architectures	N/A
<i>LRCombList</i>	List which contains the possible <i>LRComb</i> to serve a particular traffic demand	N/A
<i>LRCombListIndex</i>	Index used to select the <i>LRComb</i> in <i>LRCombList</i> for WDM MLR architectures	N/A
<i>LRCombListIndexPP</i>	Index used to select the <i>LRComb</i> in <i>LRCombList</i> in the PP for WDM MLR architectures	N/A
<i>LRCombListIndexWP</i>	Index used to select the <i>LRComb</i> in <i>LRCombList</i> in the WP for WDM MLR architectures	N/A
<i>m</i>	Number of spans in the WP	N/A
<i>Mar_{dB}</i>	Margin to account for extra power penalties due to non-linear effects, aging, operational tasks, etc.	dB
<i>MF</i>	Modulation format used in EON transmission	N/A
<i>MostEfficientAllocation</i>	Stores the information about the solution providing the highest EEPG metric, i.e. link sequence, spectral resource IDs, and line rates/MFs	N/A
<i>MostEfficientAllocationPP</i>	Stores the information about the solution for PP in DP schemes providing the highest EEPG metric, i.e. link sequence, spectral resource IDs, and line rates/modulation formats	N/A
<i>MostEfficientAllocationWP</i>	Stores the information about the solution for WP in DP schemes providing the highest EEPG metric, i.e. link sequence, spectral resource IDs, and line rates/modulation formats	N/A
<i>MP</i>	Message processing time at the node	s
<i>n</i>	Number of spans in the PP	N/A
<i>N</i>	Node degree	N/A
<i>NAmp</i>	Number of OAs that can be added or upgraded per link	N/A
<i>NAmpLinks</i>	Number of OAs in the link	N/A
<i>ND</i>	Average node degree of the network topology	N/A
<i>NFi</i>	Noise figure of the OA	dB
<i>No</i>	Number of nodes	N/A
<i>NoDataSubc</i>	Number of data subcarriers needed for the transmission of a LP	N/A
<i>Noλs</i>	Number of wavelengths used to allocate a traffic demand in the network with WDM architectures	N/A
<i>NoSubcPath</i>	Number of subcarriers needed for the transmission of a LP including GB	N/A

<i>NSimLinksToOptimize</i>	Number of simultaneous links that can be evaluated for optimization (adding new OAs or upgrading existing EDFAs to HREs)	N/A
<i>OSNR_{idB}</i>	Linear OSNR value at the output of the OA	dB
<i>OSNR_{RX}</i>	OSNR value at the receiver	dB
<i>OSNR_S</i>	OSNR at the transmission source	dB
<i>PC</i>	Power consumption	Watts
<i>PC_{LINKS}</i>	Approximated power consumption contribution in the links of a LP considering OAs and OXCs	Watts
<i>PC_{OA}</i>	Power consumption of the OA	Watts
<i>PC_{OAsLP}</i>	Contribution to power consumption of the OAs traversed by a LP	Watts
<i>PC_{OFDM}</i>	Power consumption of an OFDM subcarrier	Watts
<i>PC_{OXCPP}</i>	Power consumption of the OXCs used in the PPs in protection schemes	Watts
<i>PC_{OXC}</i>	Power consumption of the OXC	Watts
<i>PC_{OXCslp}</i>	Contribution to power consumption of the OXCs traversed by a LP	Watts
<i>PC_{OXCWP}</i>	Power consumption of the OXCs used in the WPs in protection schemes	Watts
<i>PC_{Path}</i>	Power consumption metric of a LP	Watts
<i>PCT100G</i>	Power consumption of a 100 Gbps WDM TSP	Watts
<i>PCT10G</i>	Power consumption of a 10 Gbps WDM TSP	Watts
<i>PCT40G</i>	Power consumption of a 40 Gbps WDM TSP	Watts
<i>PC_{TRANS}</i>	Power consumption of the TSPs required to serve a traffic demand	Watts
<i>PCTSP</i>	Power consumption of the TSPs	Watts
<i>PC_{TSPWP}</i>	Power consumption of the TSPs used in the WPs in protection schemes	Watts
<i>PCWDMTSP</i>	Power consumption of the chosen WDM TSP	Watts
<i>PD</i>	Propagation delay	s
<i>peakTrafficDemand</i>	Traffic demand value in the traffic matrix	Gbps
<i>P_{in}</i>	Launched power at the TSPs	dBm
<i>PP</i>	Protection path	N/A
<i>P_{RX}</i>	Power value at the receiver	dBm
<i>PSAT</i>	Saturation power at the receiver	dBm
<i>ROSNR</i>	Required OSNR at the receiver	dB
<i>RT</i>	Recovery time	s
<i>RXsensitivity</i>	Power sensitivity at the receiver	dBm
<i>SBR</i>	Service blocking ratio measures to indicate the percentage of traffic that could not be allocated in the network with respect to the total traffic	percent
<i>SEI</i>	Spectral efficiency improvements of Diff QoP with respect to DP 1+1	percent
<i>SOP_{Path}</i>	Spectral occupancy of a LP, i.e. bandwidth required to serve a traffic demand	GHz
<i>SRGList</i>	List with all the LPs affected by a particular link failure (Shared Risk Group)	N/A
<i>TMC</i>	QoP traffic class of the demands contained in the traffic matrix	N/A
<i>TO</i>	Time to configure and setup a cross-connection in the optical switch	s
<i>TotalCarriedTraffic</i>	Summation of all the traffic demands carried in the network	Gbps
<i>TotalDataTR</i>	summation of all the data transmitted in the dynamic scenario	bits
<i>TotalEC</i>	Total energy consumed during the operation of the network in the dynamic scenario	Joules
<i>TotalHighestEEPGmetric</i>	Variable to store the highest EEPG metric obtained for a LP transmission in the WP and PP	bits/Joule/GHz
<i>TotalNoSubc</i>	Total number of subcarriers per fiber	N/A
<i>TotalPC</i>	Total power consumption of the network	Watts
<i>TotalTrafficDemand</i>	Summation of all the traffic demands in the traffic matrix	Gbps
<i>TR</i>	Transmission rate	Gbps

<i>TrafficDemand</i>	Stores the information regarding source node, destination node and demand value	N/A
<i>trafficVariationFactor</i>	Traffic percentage with respect to the peak traffic	N/A
μ	Departure rate in dynamic scenario	Num. of ending requests/time unit
<i>UpdatedAllocation</i>	Stores the information regarding RWA of the different LPs after the amplifier placements optimizations	N/A
<i>WP</i>	Working path	N/A

LIST OF FIGURES

Figure 1.1. (a) Number of connected users to the Internet (based on [2]); and (b) Global Internet traffic growth (based on [3]).	1
Figure 1.2. Energy consumption growth of telecommunication networks (based on [7]).	2
Figure 2.1. Telecommunication networks architecture and segments.	7
Figure 2.2. WDM concept – Multiplexer/De-multiplexer (MUX/DEMUX) and optical spectrum.	8
Figure 2.3. Loss in a single-mode-fiber.	9
Figure 2.4. Comparison of optical spectrum utilization in: (a) DWDM; and (b) CWDM.	10
Figure 2.5. Channel allocation with (a) Current ITU-T fixed grid of 50 GHz; and (b) Flexible-grid with a FS of 25 GHz.	13
Figure 2.6. Example of network operation with: (a) Conventional fixed-grid network; and (b) Two different domains: one with fixed-grid and another with flexible-grid.	14
Figure 2.7. Main building blocks of the core optical network.	16
Figure 2.8. Optical fiber parts and principle of internal reflection.	17
Figure 2.9. Signal constellations for different modulation formats: (a) OOK; (b) QPSK; and (c) 8-QAM.	19
Figure 2.10. Spectrum savings when using OFDM-based EON with respect to ITU-T 50 GHz WDM network.	21
Figure 2.11. Potential architecture of a BV-OXC.	23
Figure 2.12. Representation of optical amplification with: (a) EDFA; and (b) Raman.	25
Figure 2.13. Representation of LP allocation in: (a) Opaque; (b) Transparent; and (c) Translucent networks.	27
Figure 2.14. Constraints for routing and resource allocation procedures in optical transport networks.	28
Figure 2.15. Spectrum for WDM MLR networks: (a) MLR of 10/40/100 Gbps; and (b) MLR of 40/100/200/400 Gbps.	29
Figure 2.16. Resource allocation in an OFDM-based EON.	30
Figure 2.17. Example of operation of (a) DP 1+1; (b) DP 1:1; (c) SP before failure occurs; and (d) SP after failure.	32
Figure 3.1. GHG emissions from ICT sector (based on [7]).	36
Figure 3.2. Energy requirements in operator networks (based on [55]).	39
Figure 4.1. Measured traffic on 29 th -31 st October 2014 at DE-CIX central exchange in Frankfurt (Germany) ([76]).	47
Figure 4.2. Comparison of service provisioning for a demand from node A to node B of 50 Gbps with different network architectures: Fixed-grid WDM SLR 10Gbps; Fixed-grid WDM MLR 10/40/100 Gbps; and EON with adaptive modulation and flexible-grid.	49
Figure 4.3. (a) TID network [101]; and (b) DT network [100].	56
Figure 4.4. Spectrum of the different network architectures: (a) ITU-T grid WDM SLR; (b) ITU-T grid WDM MLR; and (c) Flexible-grid EON.	57

Figure 4.5. EEPG –Comparison of network architectures in: (a) TID network and (b) DT network (results are not shown for those traffic scenarios where blocking exists).....	63
Figure 4.6. EE –Comparison of network architectures in: (a) TID network and (b) DT network (results are not shown for those traffic scenarios where blocking exists).....	64
Figure 4.7. SBR – Comparison of network architectures in: (a) TID network and (b) DT network (results are not shown for those traffic scenarios where blocking exists).....	65
Figure 4.8. Expected evolution of the network architectures for optical transport networks.....	65
Figure 4.9. EEPG – Comparison of network architectures in unprotected static scenario for: (a) TID network; and (b) DT network.	67
Figure 4.10. SBR - Comparison of network architectures in unprotected static scenario for: (a) TID network; and (b) DT network.	67
Figure 4.11. EEPG - Parameter sensitivity analysis of the PC of a WDM TSPs in the TID network for:.....	68
Figure 4.12. EEPG - Parameter sensitivity analysis of the PC of a WDM TSPs in the TID network for.....	69
Figure 4.13. EEPG - Parameter sensitivity analysis of the PC of a BVT in the TID network for EON architectures.	69
Figure 4.14. Parameter sensitivity analysis of the number of candidate paths (k in the KSP) in the TID network: (a) EEPG under non-blocking conditions; and (b) SBR.	70
Figure 4.15. Parameter sensitivity analysis of the transmission reach of the different transmission technologies used in the TID network: (a) EEPG under non-blocking conditions; and (b) SBR.....	71
Figure 4.16. Parameter sensitivity analysis of different metrics used in the routing and resource allocation algorithms in the TID network: (a) EEPG under non-blocking conditions; and (b) SBR... ..	72
Figure 4.17. Evolution on the operation of optical transport networks: Static operation; Semi-static operation (TAPA); and dynamic operation.....	73
Figure 4.18. Traffic variation on working and weekend-days for: (a) TID network model [101]; and (b) DT network (obtained from [104]).	74
Figure 4.19. PC variation with the TAPA approach in the TID network for overall traffic values of: (a) 19.34 Tbps; and (b) 67.70 Tbps.	80
Figure 4.20. PC variation with the TAPA approach in the DT network for overall traffic values of: (a) 30.71 Tbps; and (b) 86.57 Tbps.	80
Figure 4.21. Average daily PC savings of TAPA compared to static scenario in: (a) TID network; and (b) DT network.....	81
Figure 4.22. DEE in: (a) TID network; and (b) DT network.....	82
Figure 4.23. DSBR in: (a) TID network; and (b) DT network.	82
Figure 5.1. Example of WP and PP with different MFs in an EON architecture with DP 1+1 for a demand of 40 Gbps: (1) WP with 1x16QAM subcarrier over 450 km; and (2) PP with two 2xQPSK subcarrier over 1100 km.....	95
Figure 5.2. EEPG- Comparison of network architectures with different protection schemes in the TID network under non blocking conditions.	97
Figure 5.3. Comparison of network architectures with different protection schemes in the DT network under non blocking conditions.	97

Figure 5.4. Example of DP TAPA operation: the PP is adjusted according to the information on hourly traffic variations and permits the deactivation of one TSP.	100
Figure 5.5. Daily energy consumption savings of DP TAPA with respect to DP 1+1 on working and weekend days for the different network architectures in: (a) TID network; and (b) DT network.	101
Figure 5.6. Framework for the implementation of Diff QoP in an optical transport network: Input parameters, pre-planning stage and service provisioning [121].	105
Figure 5.7. EEI of Diff QoP with respect to DP 1+1 in the static scenario for different network architectures, traffic scenarios, traffic load values in: (a) TID Network; (b) DT Network.	110
Figure 5.8. Comparison of the original distribution of traffic in each TS and the final distribution for each TS, traffic load value and network architecture in a static scenario: (a) TS1; (b) TS2; (c) TS3; (d) TS4; (e) TS5; (f) Table with percentages of traffic classes in each TS.	111
Figure 5.9. SEI of Diff QoP with respect to DP 1+1 in a static scenario for different network architectures, traffic scenarios, traffic load values in: (a) TID Network; and (b) DT Network.	112
Figure 5.10. DEEI of Diff QoP with respect to DP 1+1 in a dynamic scenario for different network architectures, traffic scenarios, traffic load values in: (a) TID Network; (b) DT Network.	112
Figure 5.11. Comparison of the original distribution of traffic in each TS and the final distribution for each TS, traffic load value and network architecture in a dynamic scenario: (a) TS1; (b) TS2; (c) TS3; (d) TS4; (e) TS5; (f) Table with percentages of traffic classes in each TS.	113
Figure 5.12. DSBR of Diff QoP with respect to DP 1+1 in a dynamic scenario for different network architectures, traffic scenarios, traffic load values in: (a) TID Network; and (b) DT Network.	114
Figure 6.1. Node architecture model – CDC Add/Drop using MCS (based on [134] and [135]).	122
Figure 6.2. Gain versus NF values for EDFA and HRE amplification.	123
Figure 6.3. Example of power levels, amplifier gains, and losses in and end-to end transmission between node 1 and node 3 (traversing node 2) with launched power equal to 1 dBm (e.g. 100 Gbps transmission).	124
Figure 6.4. TID network scenario, showing one particular link with both fixed and potential amplifier locations [138].	125
Figure 6.5. Spectrum of the second generation of WDM MLR network (40/100/200/400 Gbps).	126
Figure 6.6. Case study with placement of additional EDFA: Example of a traffic demand of 720 Gbps between nodes F16 and F17 with DP 1+1 before and after adding two EDFAs in two of the links (F13-F15 and F15-F17).	131
Figure 6.7. (a) Distribution of TSPs per line rate with the initial configuration of OAs; and (b) Distribution of TSPs per line rate after the additional EDFA placements.	132
Figure 6.8. Comparison of the initial scenario (fixed-amplifier placements) and final scenario (after selectively placing additional in-line EDFAs) in terms of: (a) EEPG; and (b) SBR.	132
Figure 6.9. Case study with placement of additional HRE: Example of a traffic demand of 720 Gbps between nodes F16 and F17 with DP 1+1 before and after adding two HRE in link F13-F15 and one in F15-F17.	134
Figure 6.10. (a) Distribution of TSPs per line rate with the initial configuration of OAs; and (b) Distribution of TSPs per line rate after the additional HRE placements.	134
Figure 6.11. Comparison of the initial scenario (fixed-amplifier placements) and final scenario (after selectively placing additional in-line HREs) in terms of: (a) EEPG; and (b) SBR.	135

Figure 6.12. EEPG -Comparison of the two different link ordering strategies with selective placement of additional OAs: (a) EDFAs; and (b) HRE.	136
Figure 6.13. EEPG improvements achieved by the selective placement of additional OAs: (a) EDFAs; and (b) HRE.	136
Figure 6.14. Parameter sensitivity results of the PC of WDM TSPs in a MLR (40/100/200/400 Gbps) network varying the PC of the TSPs of 100, 200 and 400 Gbps: (a) Initial EEPG; and (b) Final EEPG after selective placement of EDFAs.....	137
Figure 6.15. EEPG improvements - Parameter sensitivity of the PC of the WDM TSPs in a MLR (40/100/200/400 Gbps) network varying the PC of the TSPs of 100, 200 and 400 Gbps after the selective placement of EDFAs.	138
Figure 6.16. EEPG improvement of the evaluated AS with respect to the initial amplifier configuration (<i>Init-EDFA</i>) for results without blocking.....	142
Figure 6.17. (a) Increase of network capacity of the evaluated AS with respect to the initial amplifier configuration (<i>Init-EDFA</i>) for results without blocking; and (b) SBR in the different AS.	142
Figure A.1. TID network topology indicating the location of the source (F1) and destination (F10) nodes.	167
Figure A.2. Example of wavelength occupancy in the first candidate path.....	168
Figure A.3. Example of wavelength occupancy in the first candidate path, before and after moving the GB.....	169
Figure A.4. (a) Initial network graph with first candidate path between F1 and F10 nodes; and (b) Modified network graph to calculate the potential PP candidates.	171
Figure B.1. Network scenario representing the WP and PP between nodes F16 and F17 with the initial OA placements.	173
Figure B.2. OSNR computation for the WP between nodes F16 and F17 for 400 Gbps transmission with EDFAs deployed in the initial OA placements.	173
Figure B.3. OSNR computation for the PP between nodes F16 and F17 for 400 Gbps transmission with EDFAs deployed in the initial OA placements.	174
Figure B.4. OSNR computation for the PP between nodes F16 and F17 for 400 Gbps transmission considering that in-line EDFAs deployed at fixed locations are upgraded to HRE.	175
Figure B.5. OSNR computation for the PP between nodes F16 and F17 for 400 Gbps transmissions after selectively placing new EDFAs in the links.	176
Figure B.6. OSNR computation for the PP between nodes F16 and F17 for 400 Gbps transmissions after selectively placing new HREs in the links	177

2

²Figures 2.17 and 5.1 are reprinted from Optical Switching and Networking, vol. 11, J. López Vizcaíno et al., Protection in optical transport networks with fixed and flexible grid: Cost and energy efficiency evaluation, pp. 55-71, Copyright (2014), with permission from Elsevier.

Figure 5.6 is reprinted from Optical Switching and Networking, vol. , J. López Vizcaíno et al., Differentiated quality of protection: An energy-and spectral-efficient resilience scheme for survivable static and dynamic optical transport networks with fixed-and flexible-grid, pp., Copyright (2015), with permission from Elsevier.

LIST OF TABLES

Table 2.1. Frequency bands.....	9
Table 2.2. RT for protection schemes: DP 1+1; DP 1:1; and SP.....	33
Table 3.1. Overview of energy efficiency research areas covered within this thesis.	45
Table 4.1. Input and output parameters for network planning.	54
Table 4.2. PC values of a CO-OFDM BVT for the transmission and reception of a subcarrier with different MF.	55
Table 4.3. Parameters of network topologies and reference traffic information for the TID and DT networks.	56
Table 4.4. Overview of findings in Chapter 4.	85
Table 5.1. TID network -Maximum traffic supported by the network architectures with DP and SP schemes.....	98
Table 5.2. DT network -Maximum traffic supported by the network architectures with DP and SP schemes.....	98
Table 5.3. Description of QoP traffic classes and associated RT.....	103
Table 5.4 Description of Traffic Scenarios (TS) for the Diff QoP study.	104
Table 5.5. Overview of findings in Chapter 5.	116
Table 6.1. Parameters of the different TSPs.	121
Table 6.2. Insertion/Splitting losses at the OXC.	122
Table 6.3. Example of <i>LinkList</i>	jError! Marcador no definido.
Table 6.4. Amplification scenarios (AS).	139
Table 6.5. Overview of findings in Chapter 6.	144
Table A.1. List of candidate paths from F1 to F10.....	167
Table A.2. <i>EEPGMetric</i> obtained for the candidate paths in SLR 40 Gbps and SLR 100 Gbps.	168
Table A.3. <i>LRCombList</i> sorted in descending order of EEPG at the TSPs.....	169
Table A.4. <i>EEPGMetric</i> obtained for the candidate paths in EON with the feasible MF.	170
Table A.5. List of candidate paths for WP from F1 to F10 and corresponding link-disjoint candidate paths for PP.....	171
Table A.6. Example of PPs for a LP between nodes F1 and F10 in the route F1-F14-F6-F10.	172

LIST OF ALGORITHMS

Algorithm 1. Main flow for the EA-Routing and Resource Allocation algorithms in a static scenario.	58
Algorithm 2. EA-RWA algorithm for WDM SLR network: Evaluation of new LP establishment.	60
Algorithm 3. EA-RWA algorithm for WDM MLR network: Evaluation of new LP establishment.	61
Algorithm 4. EA-RMLSA algorithm: Evaluation of new LP establishment.	62
Algorithm 5. Traffic-Aware Power-Aware (TAPA) algorithm for the semi-static scenario.	75
Algorithm 6. EA-RWA algorithm for WDM SLR in a dynamic Scenario: New flow request.	77
Algorithm 7. EA-RWA algorithm for WDM MLR in a dynamic Scenario: New flow request.	78
Algorithm 8. EA- RMLSA algorithm in a dynamic Scenario: New Flow request.	79
Algorithm 9. Main flow for the EA-Routing and Resource Allocation algorithms in a static scenario with DP.	94
Algorithm 10. Main flow for the EA-Routing and Resource Allocation algorithms in a static scenario with SP.	96
Algorithm 11. DP TAPA algorithm.	100
Algorithm 12. Diff QoP algorithm in the static scenario.	106
Algorithm 13. Diff QoP algorithm in the dynamic scenario: New flow request.	108
Algorithm 14. Main flow for the RWA MLR (40/100/200/400 Gbps) algorithm.	127
Algorithm 15. EA-RWA algorithm for WDM MLR (40/100/200/400 Gbps) network: Establishment of new LP.	128
Algorithm 16. Selective placement of additional in-line OAs to improve EEPG.	130
Algorithm 17. Selective upgrade of the in-line deployed EDFA to HRE to improve EEPG.	141

APPENDIX A. ROUTING AND RESOURCE ALLOCATION

This appendix aims at validating the proposed energy aware routing and resource allocation heuristics by presenting particular examples of service provisioning in different network architectures. As explained in the methodology of the previous chapters, the heuristics attempt to solve the routing and resource allocation independently, i.e. first the route is selected and then the resource allocation.

A.1. Routing in unprotected scenarios

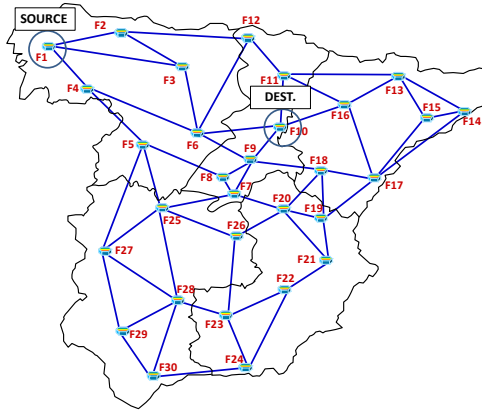

Figure A.1. TID network topology indicating the location of the source (F1) and destination (F10) nodes.

For a demand between nodes F1 and F10, different candidate paths are calculated from source to destination (KSP) by the Dijkstra's algorithm. In this scenario, k was set to 30, although only 28 different paths exist (ranging from 511 to 1055 km), as shown in Table A.1.

Table A.1. List of candidate paths from F1 to F10.

k	Candidate path	Length [km]	k	Candidate path	Length [km]
1	F1-F4-F6-F10	511	15	F1-F2-F12-F1-F16-F10	817
2	F1-F3-F6-F10	544	16	F1-F4-F5-F4-F6-F10	825
3	F1-F2-F3-F6-F10	565	17	F1-F4-F6-F9-F8-F9-F10	828
4	F1-F4-F6-F9-F10	630	18	F1-F2-F12-F1-F12-F6-F10	863
5	F1-F4-F5-F8-F9-F10	648	19	F1-F4-F5-F25-F5-F8-F9-F10	868
6	F1-F2-F12-F6-F10	661	20	F1-F3-F2-F3-F6-F10	896
7	F1-F2-F12-F1-F10	663	21	F1-F4-F5-F8-F7-F25-F7-F9-F10	910
8	F1-F4-F5-F8-F7-F9-F10	690	22	F1-F2-F12-F1-F16-F1-F10	947
9	F1-F4-F5-F25-F7-F9-F10	715	23	F1-F2-F12-F1-F13-F16-F10	962
10	F1-F4-F6-F12-F6-F10	733	24	F1-F4-F5-F8-F7-F20-F7-F9-F10	966
11	F1-F4-F6-F9-F6-F10	739	25	F1-F2-F12-F1-F13-F1-F10	971
12	F1-F4-F5-F8-F7-F8-F9-F10	752	26	F1-F4-F6-F9-F18-F9-F10	1018
13	F1-F4-F6-F9-F7-F9-F10	808	27	F1-F4-F5-F25-F26-F25-F7-F9-F10	1027
14	F1-F4-F6-F3-F6-F10	815	28	F1-F4-F5-F25-F26-F20-F7-F9-F10	1055

A.2. Resource allocation

The different candidate paths will be evaluated to provision a traffic demand of 152 Gbps between nodes F1 and F10 according to the network architecture under consideration:

A.2.1. WDM single line rate

According to Algorithm 2, it is checked whether there is transparent transmission feasibility on the existing candidate paths (transmission reach of the TSP must be greater than or equal to the path length). The transmission reach values are 2200 and 1880 km for 40 Gbps and 100 Gbps, respectively. Therefore, the physical constraints would be fulfilled for any of the calculated candidate paths. After that, it is checked whether in each of the links of the paths there are common available wavelengths (i.e. 4 and 2 wavelengths for SLR 40 Gbps and SLR 100 Gbps, respectively) to fulfill the wavelength continuity constraint. For instance, in the first candidate path, the WA would be possible since there are 5 available common wavelengths that could be used to provision the service (i.e. wavelengths 3, 5, 15, 16 and 20) as shown in Figure A.2. Hence, for this and the other feasible candidate paths, an *EEPGMetric* is calculated as in Eq. (2).

Wavelength position	1	2	3	4	5	6	7	8	9	10	11	12	13	14	15	16	17	18	19	20
F1-F4	1	0	0	0	0	0	0	0	0	1	0	0	1	1	0	0	1	0	0	0
F4-F6	0	1	0	1	0	1	0	1	0	0	1	0	0	0	0	0	0	0	1	0
F6-F10	0	0	0	1	0	0	1	0	1	0	0	1	0	1	0	0	0	1	0	0

0: unassigned wavelength 1: assigned wavelength

Figure A.2. Example of wavelength occupancy in the first candidate path.

Being PC_{TRANS} and $SOPath$ constant for all the candidate paths (i.e. the same type of TSP has to be employed), the only variable factor for the calculation of *EEPGMetric* is PC_{LINKS} in Eq. (10). In other words, the most convenient allocation mainly depends on the PC of the number of traversed nodes and OAs along the path. Assuming that the network has available spectral resources in all the paths, the following *EEPG* metrics are obtained for the first five paths as shown in Table A.2.

As can be noticed, the first candidate path offers the maximum *EEPGMetric* as it traverses four nodes (F1, F4, F6 and F10) and 4 in-line OAs (one in F1-F4 link, two in F4-F6 link, and one in F6-F10), while the other possibilities include a larger number of OAs and/or OXCs. Accordingly, the service provisioning will be realized in the first candidate path ($k=1$) in both SLR approaches.

Table A.2. *EEPGMetric* obtained for the candidate paths in SLR 40 Gbps and SLR 100 Gbps.

k	SLR 40G		SLR 100G	
	$PCPath$ [W]	<i>EEPG</i> Metric [bits/Joule/GHz]	$PCPath$ [W]	<i>EEPG</i> Metric [bits/Joule/GHz]
1	624.68	1216623	918.34	1655160
2	629.6875	1206948	920.84	1650667
3	628.0625	1210071	920.03	1652120
4	632.56	1201467	922.28	1648090
5	636.125	1194734	924.06	1644915

A.2.2. WDM mixed line rate

The RWA in WDM MLR follows the steps described in Algorithm 3. As mentioned earlier, in a WDM MLR architecture, a particular traffic demand can be provisioned by different combinations of TSPs (i.e. *LRComb*). Therefore, the potential *LRComb* are calculated to serve the traffic demand of 152 Gbps and sorted in descending order of *EEPG* at the TSPs, as shown in the *LRCombList* presented in Table A.3. In this example, the three line rates (10, 40 and 100 Gbps) can be used as they provide enough transmission reach in the candidate paths of Table A.1.

Table A.3. *LRCombList* sorted in descending order of *EEPG* at the TSPs.

<i>LRCombIndex</i>	Number of TSPs			PC of the TSPs [W]	<i>EEPGMetric</i> at the TSPs[bits/Joule/GHz]
	10Gλs	40Gλs	100Gλs		
1	0	0	2	702	2165242
2	0	4	0	392	1938776
3	0	2	1	547	1852529
4	2	1	1	517	1470019
5	4	3	0	430	1009967
6	6	0	1	555	782496.8
7	8	2	0	468	649572.6
8	12	1	0	506	462146.5
9	16	0	0	544	349264.7

As shown, the preferred *LRComb* for the allocation would be the one composed of 2 TSPs of 100 Gbps (*LRCombIndex* equal to 1). The WA evaluation is then started for the first *LRComb* in all the candidate paths presented in Table A.1. The WA for MLR is significantly different from that carried out for SLR due to the presence of two wavebands separated by a GB of 4 wavelengths (i.e. the first waveband is used for 10 Gbps transmissions, whereas the second one is dedicated to 40/100 Gbps). As can be noticed, the two first *LRComb* correspond to the cases of SLR 100 Gbps and SLR 40 Gbps, which were presented in the previous section. If there are enough and common wavelengths on the second part of the spectrum in any of the candidate paths, these options will be preferred for WA as they provide higher *EEPG* (especially the *LRCombs* with SLR 100 Gbps as shown in Table A.2).

One particularity of MLR is given by the presence of a GB that can be moved whether more wavelengths are required on the first or second part of the spectrum. For instance, in the example presented in Figure A.3, there is only one available wavelength on the second band, but the GB of the first link (F1-F4) can be moved one wavelength position to the left to increase the number of 40/100 Gbps. This will enable the utilization of the first *LRComb* in the list (*LRCombIndex* equal to 1, which employs 2 TSPs of 100 Gbps).

Wavelength position	1	2	3	4	5	6	7	8	9	10	11	12	13	14	15	16	17	18	19	20
F1-F4	1	0	0	0	0	0	0	0	0	1	0	0	1	1	0	0	1	0	0	0
F4-F6	0	1	0	1	0	1	0	1	0	0	1	0	0	0	0	0	0	0	1	0
F6-F10	0	0	0	1	0	0	1	0	1	0	0	1	0	1	0	0	0	1	0	0

0: unassigned wavelength

1: assigned wavelength

Figure A.3. Example of wavelength occupancy in the first candidate path, before and after moving the GB.

A.2.3. Elastic optical network

The RMLSA in EON follows the steps described in Algorithm 4. For each of the candidate paths in Table A.1, it is checked which MF meet the physical constraints in terms of transmission reach. For those paths whose length is between 500 and 1000 km, three MFs can be used (i.e. BPSK, QPSK and 8QAM), whereas for those with distances over 1000 km, only BPSK and QPSK would be feasible. The number of required subcarriers including GB varies according to the MF i.e. 15, 9 and 7 subcarriers with BPSK, QPSK and 8QAM formats, respectively.

For those candidate paths where common spectral resources are available along all the links, an *EEPGMetric* is calculated for the different MFs as in Eq. (2). The *EEPGMetric* calculated for the

first five candidate paths is shown in Table A.4. As can be seen, 8-QAM is definitely the most energy- and spectral-efficient MF choice (based on the *EEPGMetric*) in any of the evaluated candidate paths. Moreover, 8-QAM is also the MF that requires the reservation of a smaller number of subcarriers, which also increases the chances of finding a suitable spectrum range available in the links of the candidate path.

Regarding the spectrum allocation, similarly to the WA in WDM architectures, the wavelength (or spectrum) continuity constraint must be fulfilled. Furthermore, it is also necessary to consider the contiguity constraint (subcarriers in the super-channel must be contiguous).

Table A.4. *EEPGMetric* obtained for the candidate paths in EON with the feasible MF.

<i>k</i>	BPSK		QPSK		8-QAM	
	<i>PCPath</i> [W]	<i>EEPG Metric</i> [Mb/Joule/GHz]	<i>PCPath</i> [W]	<i>EEPGMetric</i> [Mb/Joule/GHz]	<i>PCPath</i> [W]	<i>EEPGMetric</i> [Mb/Joule/GHz]
1	1691.5	299.5369	1152.3	732.83385	986.586	1100.47607
2	1696.2	298.70691	1155.1	731.05744	998.77	1087.05136
3	1694.7	298.9713	1154.2	731.62749	988.06	1098.83437
4	1698.9	298.23219	1156.7	730.0462	990.03	1096.64786
5	1702.2	297.65402	1158.7	728.78609	991.59	1094.92258

A.3. Protected scenarios

The following sections provide some examples to validate the correct operation of the algorithms used in Chapters 5 and 6 for DP and SP schemes.

A.3.1. Dedicated protection

The routing and resource allocation tasks with DP follow the steps described in Algorithm 9.

A.3.1.1. Routing

Two independent paths must be provided, one for WP and another for PP, which is completely link-disjoint from the WP. Thus, for each of the candidates for WP, the potential PPs must be calculated. Basically, the KSP are first calculated in the initial network topology, and then for each candidate path, the KSP algorithm is executed again in a modified network topology (where the links that the path is composed of have been pruned). An example is shown for the first candidate path (*k* equal to 1) in Figure A.4b, where the links of the candidate path (F1-F4, F4-F6 and F6-F10) have been deleted.

Table A.5 shows a set of candidate link-disjoint PP for the two first candidates WPs (*k*=1 and *k*=2) between F1 and F10 nodes. Note that in the *k*-disjoint paths can be evaluated for each candidate WP.

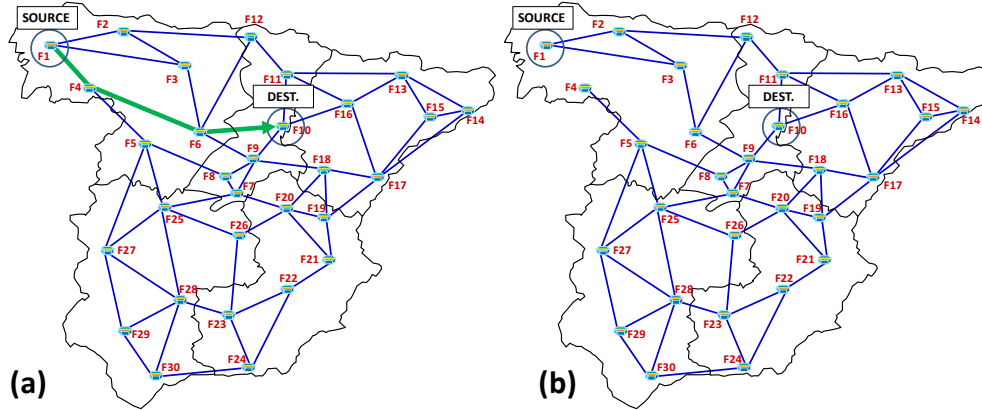

Figure A.4. (a) Initial network graph with first candidate path between F1 and F10 nodes; and (b) Modified network graph to calculate the potential PP candidates.

Table A.5. List of candidate paths for WP from F1 to F10 and corresponding link-disjoint candidate paths for PP.

k	Candidate WP	Length [km]	Candidate PP	Length [km]
1	F1-F4-F6-F10	511	F1-F2-F12-F1F1-F10	663
			F1-F2-F12-F1F1-F16-F10	817
			F1-F2-F12-F1F1-F13-F16-F10	962
			F1-F2-F12-F1F1-F13-F15-F17-F16-F10	1236
			F1-F2-F12-F1F1-F16-F17-F18-F9-F10	1261
			F1-F2-F12-F1F1-F16-F17-F19-F18-F9-F10	1356
			F1-F2-F12-F1F1-F13-F14-F17-F16-F10	1365
2	F1-F3-F6-F10	544	F1-F4-F6-F9-F10	630
			F1-F4-F5-F8-F9-F10	648
			F1-F2-F12-F1F1-F10	663
			F1-F4-F5-F8-F7-F9-F10	690
			F1-F4-F5-F25-F7-F9-F10	715
			F1-F2-F12-F1F1-F16-F10	817
			F1-F2-F12-F1F1-F13-F16-F10	962
			F1-F4-F5-F25-F26-F20-F7-F9-F10	1055
			F1-F4-F5-F8-F7-F20-F18-F9-F10	1062
			F1-F4-F5-F27-F25-F7-F9-F10	1094
			F1-F4-F6-F9-F18-F17-F16-F10	1112
			F1-F4-F5-F8-F7-F20-F19-F18-F9-F10	1156
			F1-F4-F5-F8-F7-F20-F19-F17-F16-F10	1183

A.3.1.2. Resource allocation

The resource allocation with DP is performed in a similar manner to that in the unprotected scenario, but jointly considering the best allocation on WP and PP. In other words, for those combinations of candidate WP and PP where the physical constraints are fulfilled and spectral resources are available in the links of the LP, a common EEPG metric (*TotalMetricEEPG*) is calculated considering both the contribution of the WP (*EEPGMetricWP*) and PP (*EEPGMetricPP*).

The main particularity comes in the case of EON and WDM MLR architectures, where the WP and PP are not forced to use the same *MF/LRComb* on the WP and PP.

A.3.2. Shared protection

The service provisioning with SP is shown in Algorithm 10. After provisioning all the traffic demands on the WPs, the failure of each network link is emulated. Then, a set of PPs is provided for each LP using the remaining spectral resources not used for working traffic. For instance, for an LP between nodes F1 and F10 in the route F1-F4-F6-F10, several PPs have to be determined to

be used in case of failure. First, the link between nodes F1 and F4 is pruned from the network graph and the spectral resources of that LP are released. After that, the establishment of a new LP in the modified graph, which cannot traverse the mentioned link, is evaluated. Among the feasible alternatives (those offering enough spectral resources), the one providing the highest *EEPGMetric* will be adopted. Table A.6 shows the potential PPs that can be used for this LP of 152 Gbps between F1 and F10.

As can be seen, with SP as protection scheme, the PPs can be significantly shorter than using DP, as the new paths only have to be disjoint from a single link at a time. Therefore, SP not only provides a better utilization of the spectral resources, but also permits to use more spectral-efficient MF/LR on the PP compared to DP.

Table A.6. Example of PPs for a LP between nodes F1 and F10 in the route F1-F14-F6-F10.

Link failure	PP	Length [km]
F1-F4	F1-F2-F3-F6-F10	565
F4-F6	F1-F2-F3-F6-F10	565
F6-F10	F1-F4-F6-F9-F10	630

APPENDIX B. AMPLIFIER PLACEMENTS

This appendix aims at validating the calculation of the physical constraints (based on OSNR) in the different amplification scenarios by providing some specific examples.

B.1. Fixed EDFA locations

For the establishment of a LP in the network, the physical layer constraints have to be met. In Chapter 6, the fulfillment of the mentioned constraints is evaluated by computing the OSNR level at the receiver ($OSNR_{RX}$) and checking whether its value is greater or equal than the required one (ROSNR) at the TSP (according to Table 6.1). In the OSNR computation, the different network elements that are traversed by the LPs (e.g. optical fiber, OXC and OAs) are taken into account as explained in Section 6.4.3.

For example, a WP and a PP have to be provided to provision a traffic demand between F16 and F17 as shown in Figure B.1. Assuming that the most energy- and spectral-efficient *LRCComb* contains 400 Gbps TSPs, the OSNR computation is performed on both paths by considering the initial OA placements where EDFAs are deployed.

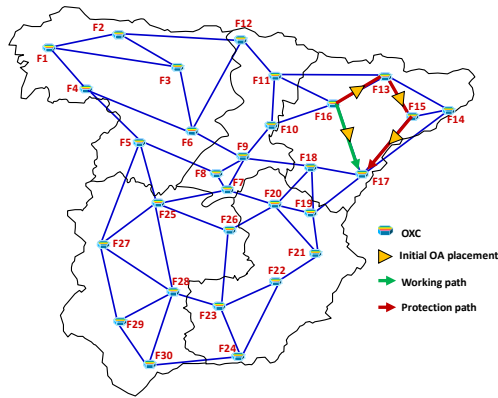

Figure B.1. Network scenario representing the WP and PP between nodes F16 and F17 with the initial OA placements.

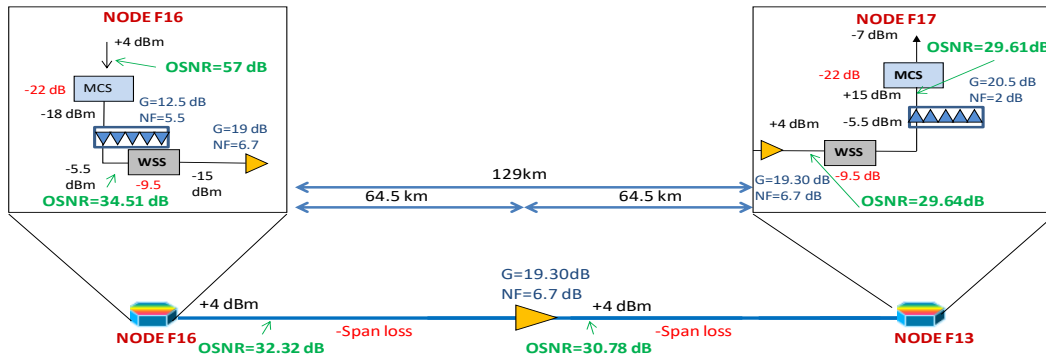

Figure B.2. OSNR computation for the WP between nodes F16 and F17 for 400 Gbps transmission with EDFAs deployed in the initial OA placements.

The OSNR computation for the WP is shown in Figure B.2. Given the fact that a direct (and not significantly long) link exists between source and destination nodes (129 km), an $OSNR_{RX}$ of 29.61 dB has been obtained. This value is greater than the summation of the ROSNR and the margin (23.5 dB + 3 dB). Thus, the transmission with 400 Gbps TSPs is feasible for this path.

Regarding the PP, the OSNR computation is presented in Figure B.3. In this case the path is significantly longer (411 km) and has to traverse two intermediate nodes. As can be seen, the received OSNR with 400 Gbps is 25.55 dB which is lower than the required level (26.5 dB). Therefore, the transmission cannot be realized with 400 Gbps, making it necessary to use TSPs with lower rate such as 200 Gbps or 100 Gbps.

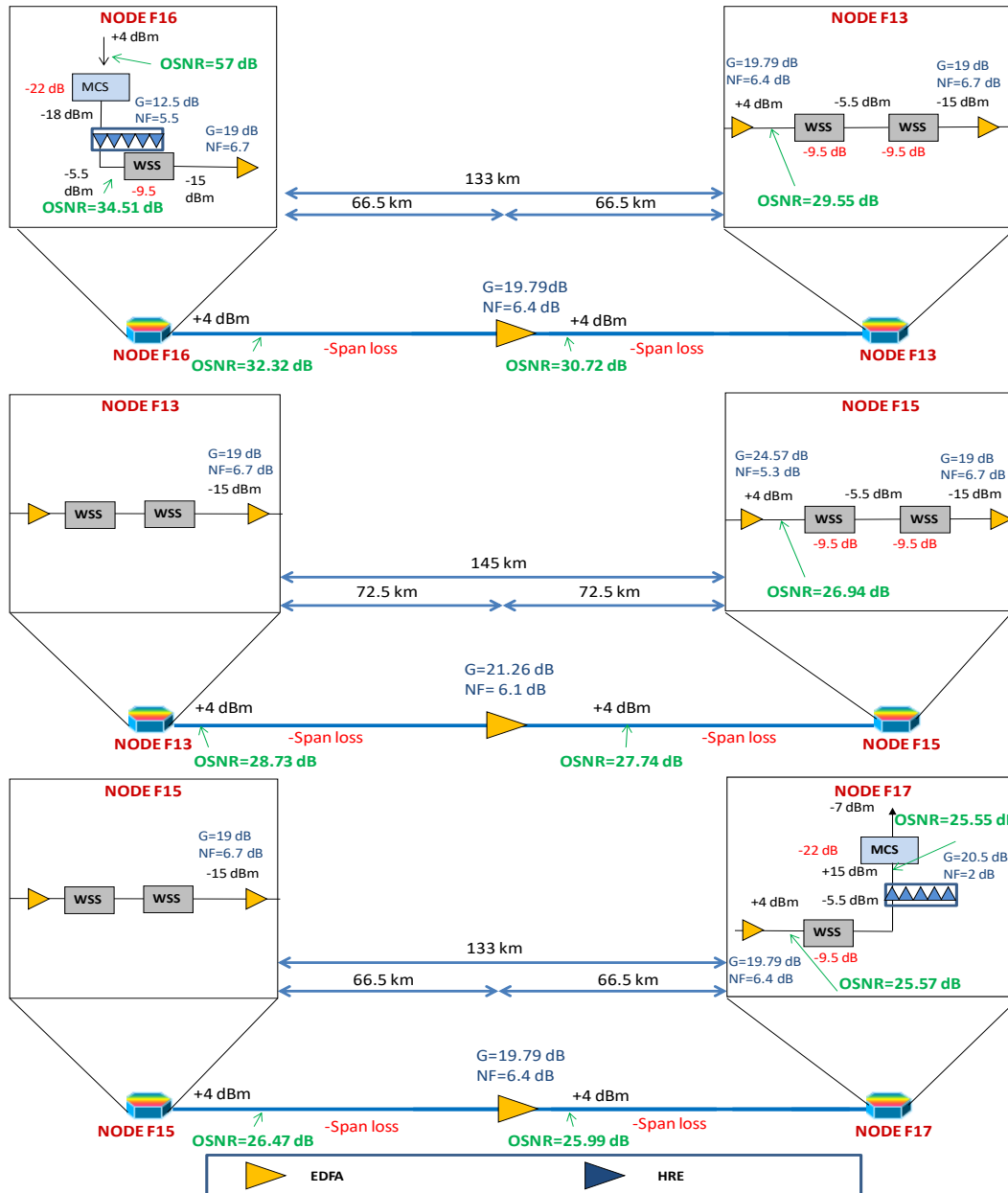

Figure B.3. OSNR computation for the PP between nodes F16 and F17 for 400 Gbps transmission with EDFAs deployed in the initial OA placements.

B.2. Upgrading EDFAs to HREs

Following the procedure in Algorithm 17, the fixed in-line EDFAs are upgraded to HRE in the previous example and the OSNR is recomputed for the PP to check whether it could be improved to enable 400 Gbps transmissions. The OSNR computation is shown in Figure B.4. As presented, upgrading the in-line EDFAs to HRE brings an improvement of 0.89 dB with respect to the initial scenario with all EDFA (26.44 dB compared to 25.55 dB). However, this improvement is not enough to transmit with 400 Gbps in this particular path.

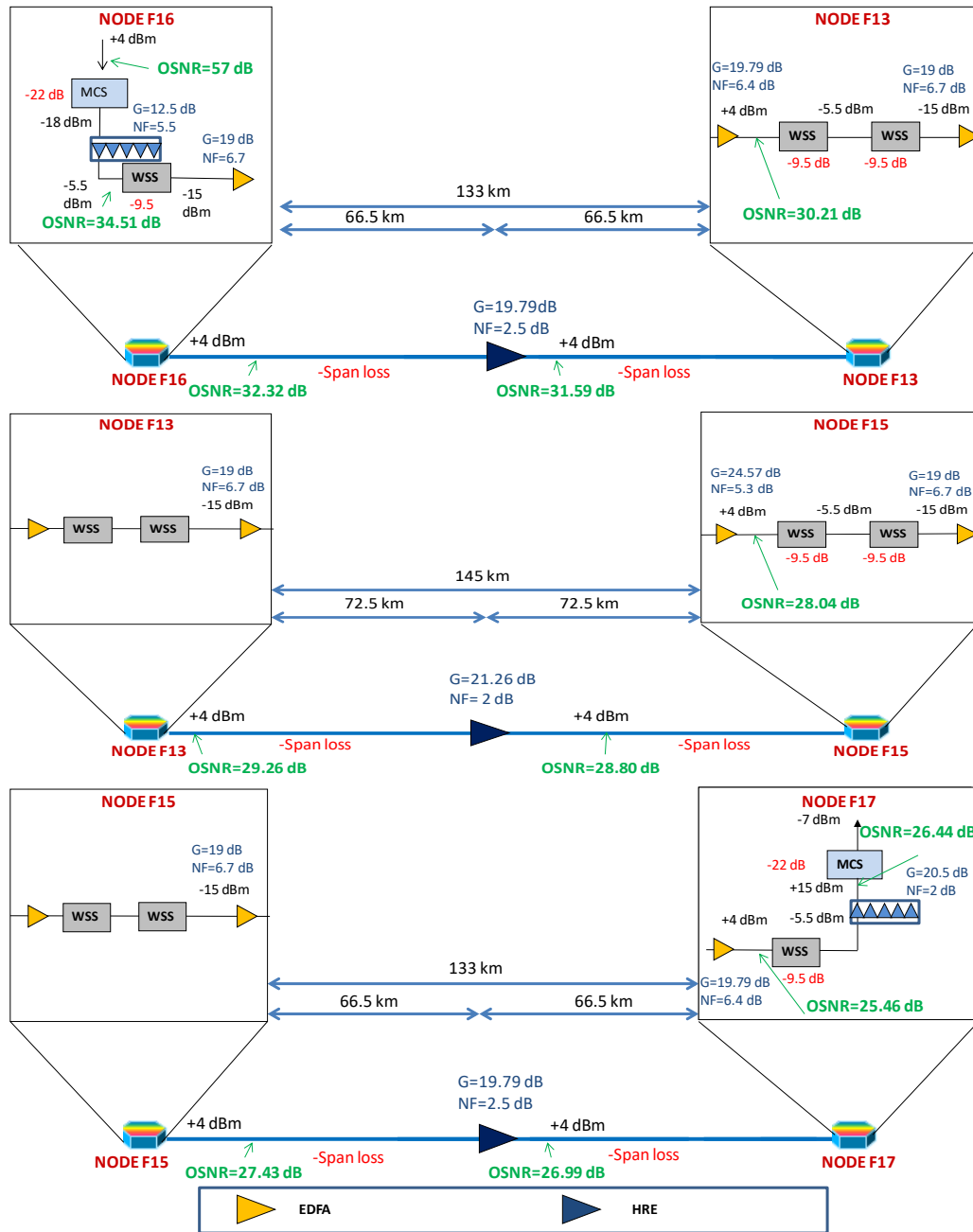

Figure B.4. OSNR computation for the PP between nodes F16 and F17 for 400 Gbps transmission considering that in-line EDFAs deployed at fixed locations are upgraded to HRE.

B.3. Selective placement of additional EDFAs

One of the potential amplification strategies evaluated in Chapter 6 is the selective placement of additional OAs to improve the OSNR of the network following the steps described in Algorithm 16. This strategy has been applied to the PP between nodes F16 and F17. Figure B.5 presents the appearance of the links after the optimization. As shown, two additional EDFAs are placed in the second link (F13-F15) and two more on the third link (F15-F17). This allows the optical signal power not to drop significantly along the transmission and provide a $OSNR_{RX}$ of 26.52 dB which is greater than the required level (26.5 dB), thus enabling 400 Gbps transmissions.

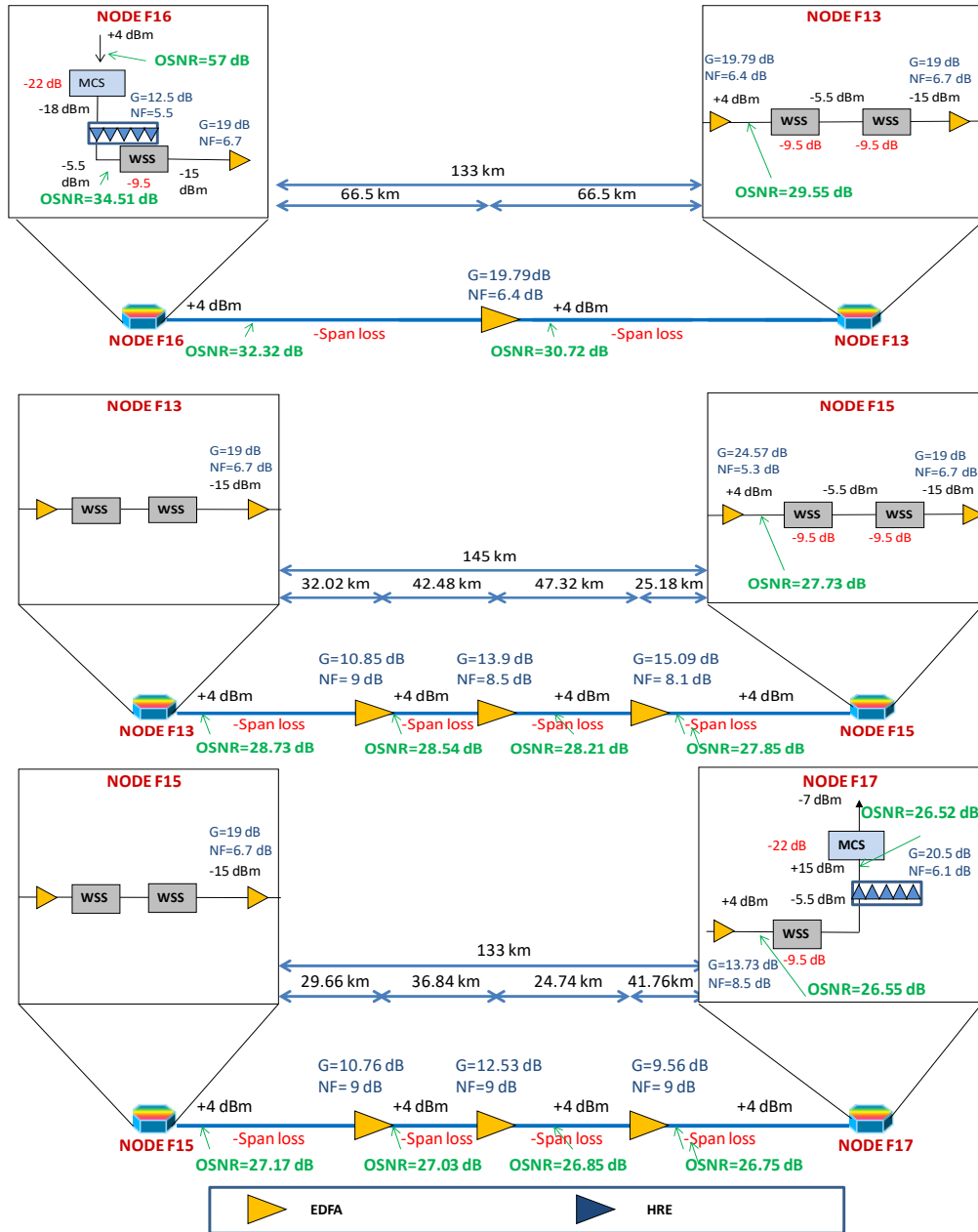

Figure B.5. OSNR computation for the PP between nodes F16 and F17 for 400 Gbps transmissions after selectively placing new EDFAs in the links.

B.4. Selective placement of additional HREs

Similarly to the previous section, the selective placement of additional in-line HREs has been considered following the methodology in Algorithm 16. The OSNR computation is presented in Figure B.6. As shown, placing two HREs in the second link and another one in the third, $OSNR_{RX}$ can be improved up to 26.55 dB. The low NF of HRE permits to obtain similar OSNR improvement with three HREs to that obtained in the previous section with four EDFAs.

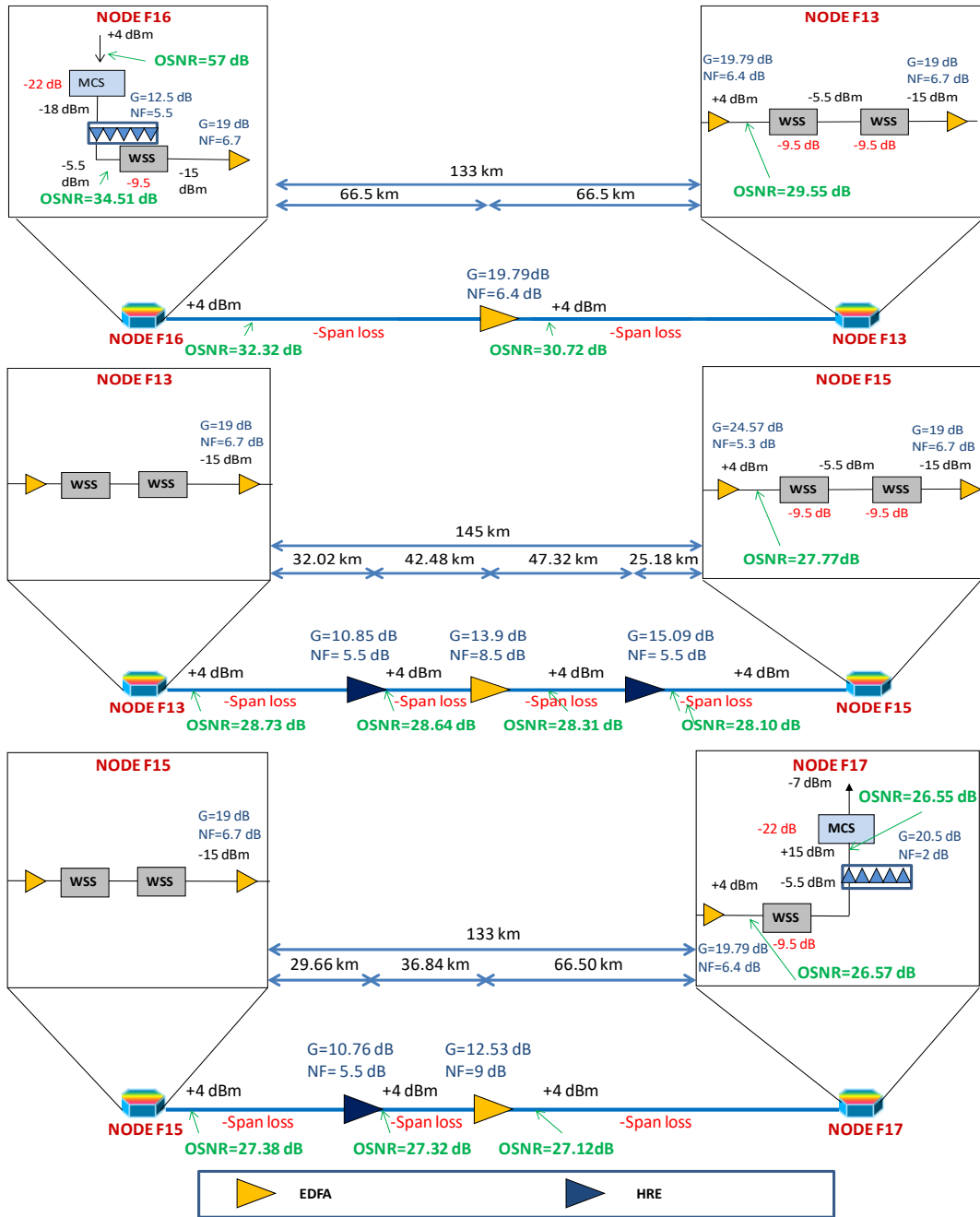

Figure B.6. OSNR computation for the PP between nodes F16 and F17 for 400 Gbps transmissions after selectively placing new HREs in the links

BIBLIOGRAPHY

- [1] Google Fiber, <https://fiber.google.com/about/>, accessed in March 2015
- [2] Internet live stats, <http://www.internetlivestats.com/internet-users/>, accessed in March 2015.
- [3] Cisco, "Cisco Visual Networking Index (VNI)," <http://www.cisco.com/c/en/us/solutions/service-provider/visual-networking-index-vni/index.html>, June 2014.
- [4] Ericsson, "Ericsson Mobility Report," <http://www.ericsson.com/res/docs/2014/ericsson-mobility-report-june-2014.pdf>, June 2014.
- [5] S. Lambert, W. Van Heddeghem, W. Vereecken, B. Lannoo, D. Colle, and M. Pickavet, "Worldwide electricity consumption of communication networks," *Optics Express*, Vol. 20, Issue 26, pp. B513-B524, 2012.
- [6] F.Cucchietti, "Telecom Italia -Energy Efficiency and ICT: short term needs long term opportunities," <http://www.slideshare.net/iMindsconference2010/1430-1-cucchietti-imindsgent122010>, December 2010.
- [7] Y. Zhang, P. Chowdhury, M. Tornatore, and B. Mukherjee, "Energy Efficiency in Telecom Optical Networks," *IEEE Communications Surveys & Tutorials*, vol.12, no.4, pp. 441-458, Nov. 2010.
- [8] International Telecommunications Union, "ITU and Climate Change Report," Oct. 2008.
- [9] C. Herrmann, A. Saraev, L.-G. Scheidt, "Green IT: A holistic approach for identifying sustainable performance," *Electronics Goes Green 2012+ (EGG)*, 2012, vol., no., pp.1,6, 9-12 Sept. 2012.
- [10] ITU-T Recommendation G.694.1, "Spectral grids for WDM applications: DWDM frequency grid," June 2012.
- [11] ITU-T Recommendation G.694.2, "Spectral grids for WDM applications: CWDM wavelength grid", Dec. 2003.
- [12] A. Napoli, M. Bohn, D. Rafique, A. Stavdas, N. Sambo, L. Poti, M. Nolle et al. "Next generation elastic optical networks: The vision of the European research project IDEALIST," *IEEE Communications Magazine*, vol. 53, no. 2, pp. 152-162, 2015.
- [13] O. Gerstel, M. Jinno, A. Lord, S.J.B. Yoo, "Elastic optical networking: a new dawn for the optical layer?," *IEEE Communications Magazine*, vol.50, no.2, pp.s12-s20, February 2012
- [14] G. Zhang, M. De Leenheer, A. Morea, B. Mukherjee "A survey on OFDM-based elastic core optical networking", *IEEE Communications Surveys & Tutorials*, vol 15, issue 1, pp. 65-87, 2013.
- [15] I. Tomkos, E. Palkopoulou, M. Angelou. "A survey of recent developments on flexible/elastic optical networking." 14th IEEE International Conference in Transparent Optical Networks (ICTON), pp. 1-6, 2012.
- [16] M. Jinno, H. Takara, B. Kozicki, Y. Tsukishima, T. Yoshimatsu, T. Kobayashi, Y. Miyamoto, K. Yonenaga, a Takada, O. Ishida, and S. Matsuoka, "Demonstration of novel spectrum-efficient elastic optical path network with per-channel variable capacity of 40 Gb/s to over 400 Gb/s," 34th European Conference on Optical Communication, pp. 1-2, Sep. 2008.
- [17] Y. Sone, A. Watanabe, W. Imajuku, Y. Tsukishima, B. Kozicki, H. Takara, M. Jinno, "Bandwidth Squeezed Restoration in Spectrum-Sliced Elastic Optical Path Networks (SLICE)," *IEEE/OSA Journal of Optical Communications and Networking*, vol.3, no.3, pp.223,233, Mar. 2011.
- [18] X. Shao, Y. Yeo, Z. Xu, X. Cheng, and L. Zhou, "Shared-Path Protection in OFDM-based Optical Networks with Elastic Bandwidth Allocation," *Optical Fiber Communication Conference*, pp. OTh4B-4., Mar. 2012.
- [19] D. Klondis, F. Cugini, O. Gerstel, M. Jinno, V. Lopez, E. Palkopoulou, M. Sekiya, D. Siracusa, G. Thouenon, C. & Betoule, C. Betoule, "Spectrally and spatially flexible optical network planning and operations," *IEEE Communications Magazine*, vol. 53, no. 2, pp. 69-78, 2015.
- [20] J. Zhang, Y. Zhao, H. Yang, Y. Ji, H. Li, Y. Lin, G. Li, J. Han, Y. Lee, T. Ma. "First demonstration of enhanced software defined networking (eSDN) over elastic grid (eGrid) optical networks for data center service migration," *National Fiber Optic Engineers Conference (OFC/NFOEC)*, pp. PDP5B-1, 2013.
- [21] R. Ramaswami, K. Sivarajan, G. Sasaki, "Optical networks: a practical perspective", ISBN: 9780080920726, Morgan Kaufmann, 2009.
- [22] B. Kozicki, H. Takara, Y. Tsukishima, T. Yoshimatsu, K. Yonenaga, and M. Jinno, "Experimental demonstration of spectrum-sliced elastic optical path network (SLICE)," *Optics express*, vol. 18, pp. 22105-18, Oct. 2010.
- [23] H. Takara, B. Kozicki, Y. Sone, and M. Jinno, "Spectrally-efficient elastic optical path networks," *Optoelectronics and Communications Conference (OECC) 2010*, July 2010.
- [24] M. Jinno, T. Hidehiko, S. Y. Sone, K. Yonenaga, A. Hirano. "Multiflow optical transponder for efficient multilayer optical networking," *IEEE Communications Magazine*, vol. 50, no. 5, pp. 56-65, 2012.
- [25] N. Sambo, P. Castoldi, A. D'Errico, E. Riccardi, A. Pagano, M. Svaluto Moreolo, Josep M. Fabrega et al. "Next generation sliceable bandwidth variable transponders," *IEEE Communications Magazine*, vol. 53, no. 2, pp. 163-171, 2015.
- [26] G. Papadimitriou, C. Papazoglou, A. S. Pomportsis. "Optical switching: switch fabrics, techniques, and architectures." *Journal of lightwave technology*, vol. 21, no. 2, pp. 384, 2003.

- [27] S. Frisken, G. Baxter, D. Abakoumov, H. Zhou, I. Clarke, S. Poole. "Flexible and grid-less wavelength selective switch using LCOS technology," Optical Fiber Communication Conference (OFC), pp. OTuM3, 2011.
- [28] B. Mukherjee, "Optical WDM networks," ISBN 0387291881, Springer Science & Business Media, 2006.
- [29] E. W. Dijkstra, "A note on two problems in connexion with graphs," *Numerische mathematik* 1, no. 1, pp. 269-271, 1959.
- [30] N. Sambo, M. Secondini, F. Cugini, G. Bottari, P. Iovanna, F. Cavaliere, P. Castoldi. "Modeling and distributed provisioning in 10–40–100-Gb/s multirate wavelength switched optical networks." *Journal of Lightwave Technology*, vol. 29, no. 9, pp. 1248-1257, 2011.
- [31] Y. Yin, K. Wen, D. J. Geisler, R. Liu, S. J. B. Yoo. "Dynamic on-demand defragmentation in flexible bandwidth elastic optical networks." *Optics express*, vol. 20, no. 2, pp. 1798-1804, 2012.
- [32] R. Asthana, Y. N. Singh, W. D. Grover. "p-Cycles: An overview," *IEEE communications surveys & tutorials*, vol. 12, no. 1, pp. 97-111, 2010.
- [33] T. Sakano, Z. M Fadhullah, T. Ngo, H. Nishiyama, M. Nakazawa, F. Adachi, N. Kato et al. "Disaster-resilient networking: a new vision based on movable and deployable resource units." *IEEE Network*, vol. 27, no. 4, pp. 40-46, 2013.
- [34] ICT footprint initiative, "<http://www.ict-footprint.com/>," accessed in March 2015.
- [35] W. Van Heddeghem, S. Lambert, B. Lannoo, D. Colle, M. Pickavet, P. Demeester, "Trends in worldwide ICT electricity consumption from 2007 to 2012", *Computer Communications*, vol. 50, pp. 64-76, 2014.
- [36] J. Baliga, R. Ayre, K. Hinton, R. S. Tucker, "Photonic Switching and the Energy Bottleneck," *Proc. Internat. Conf. Photonics in Switching*, pp. 125-126, 2007.
- [37] Energy Information Administration Brochures, "Greenhouse gases, climate change, and energy," <http://www.eia.doe.gov/bookshelf/brochures/greenhouse/Chapter1.htm>, May 2008.
- [38] K. Hinton, J. Baliga, R. Ayre, R.S. Tucker, "The future Internet - An energy consumption perspective," *OptoElectronics and Communications Conference (OECC)*, Jul. 2009
- [39] J. Baliga, R. Ayre, K. Hinton, W.V. Sorin, R.S. Tucker, "Energy Consumption in Optical IP Networks," *Journal of Lightwave Technology*, vol. 27, No. 13, pp. 2391-2403, Jul. 2009.
- [40] W. Van Heddeghem, F. Idzikowski, F. Musumeci, A. Pattavina, B. Lannoo, D. Colle, M. Pickavet, "A power consumption sensitivity analysis of circuit-switched versus packet-switched backbone networks," *Computer Networks*, Vol. 78, pp. 42-56, ISSN 1389-1286, 2015.
- [41] W. Vereecken, W.V. Heddeghem, B. Puype, D. Colle, M. Pickavet, and P. Demeester, "Optical Networks : How Much Power Do They Consume and How Can We Optimize This ?," *European Conference on Optical Communications (ECOC)*, Sep. 2010.
- [42] GeSI, "SMART 2020: Enabling the low carbon economy in the information age," 2008.
- [43] International Telecommunications Union, "ICTs and Energy Efficiency," http://www.itu.int/en/action/climate/Pages/energy_efficiency.aspx, accessed in March 2015.
- [44] GreenTouch Consortium, "<http://www.greentouch.org/>," accessed in February 2015
- [45] Gesi, "SMARTer 2020: The Role of ICT in Driving a Sustainable Future," December 2012
- [46] European Union Seventh Framework Programme TREND, <http://www.fp7-trend.eu/>, accessed in February 2015.
- [47] European Union Seventh Framework Programme ECONET, <http://www.econet-project.eu/>, accessed in February 2015.
- [48] Orange, "Corporate Social Responsibility," <http://interactivedocument.labrador-company.com/Labrador/EN/Orange/2013RADD/?Page=82>, 2013.
- [49] Telecom Italia, "Sustainability report 2013," http://www.telecomitalia.com/content/dam/telecomitalia/en/archive/documents/sustainability/sustainability_reports/2013/Bilancio-Sostenibilita-2013-ENG.pdf, 2013.
- [50] British Telecom Group, "Sustainability Report 2009", <http://www.btplc.com/Societyandenvironment/Ourapproach/Sustainabilityreport/index.aspx>, 2009.
- [51] Huawei Technologies, "Sustainability Report 2013," <http://www.huawei.com/en/about-huawei/sustainability/sustainability-report/>, 2013.
- [52] Ericsson, "Technology for Good – Ericsson Sustainability and Corporate Responsibility Report 2013," <http://www.ericsson.com/res/thecompany/docs/corporate-responsibility/2013-corporate-responsibility-and-sustainability-report.pdf>, 2013.
- [53] Infinera, "Infinera's 400 Gb/s PIC sets new record for integration", http://www.in_nera.com/j7/servlet/NewsItem?newsItemID=150, accessed in March 2015.
- [54] C. Lange, D. Kosiankowski, R. Weidmann, A. Gladisch, "Energy consumption of telecommunication networks and related improvement options," *IEEE Journal of Selected Topics in Quantum Electronics*, 17(2), 285-295., 2011

- [55] R. Bolla, R. Bruschi, F. Davoli, F. Cucchietti., "Energy Efficiency in the Future Internet: A Survey of Existing Approaches and Trends in Energy-Aware Fixed Network Infrastructures," *IEEE Communications Surveys & Tutorials*, vol.13, no.2, pp.223,244, 2011.
- [56] M. Gupta and S. Singh,"Greening of the Internet," *Proc. ACM SIGCOMM Conf. (SIGCOMM 03)*, pp. 19-26, Aug. 2003.
- [57] K. Christensen, B. Nordman, R. Brown,"Power Management in Networked Devices," *IEEE Computer*, vol. 37, no. 8, pp. 91-93, Aug. 2004.
- [58] R.S. Tucker., "Green Optical Communications—Part I: Energy Limitations in Transport," *IEEE Journal of Selected Topics in Quantum Electronics*, , vol.17, no.2, pp.245,260, March-April 2011
- [59] R.S. Tucker, "Green Optical Communications — Part II : Energy Limitations in Networks," *IEEE Journal of Selected Topics in Quantum Electronics*, vol.27, no.2, pp.261-274, Mar./Apr. 2011.
- [60] A.P Bianzino, C. Chaudet, D. Rossi, J. Rougier, "A Survey of Green Networking Research," *IEEE Communications Surveys & Tutorials*, vol.14, no.1, pp.3-20, 2012.
- [61] M.N.Dharmaweera, R. Parthiban, Y.A Sekercioglu, "Toward a Power-Efficient Backbone Network: The State of Research," *IEEE Communications Surveys & Tutorials*, vol.17, no.1, pp.198-227, 2015.
- [62] W. Van Heddeghem, B. Lannoo, D. Colle, M. Pickavet, P. Demeester, "A Quantitative Survey of the Power Saving Potential in IP-over-WDM Backbone Networks," *IEEE Communications Surveys & Tutorials*, vol.PP, no.99, pp.1,1, 2014.
- [63] H. Zhang, S. Shao, H. Xu, H. Zou, C. Tian, "Free cooling of data centers: A review," *Renewable and Sustainable Energy Reviews*, vol. 35, pp. 171-182, ISSN 1364-0321, July 2014.
- [64] P. Dong; X. Liu, S. Chandrasekhar, L.L. Buhl, R. Aroca, Young-Kai Chen, "Monolithic Silicon Photonic Integrated Circuits for Compact 100 + Gb/s Coherent Optical Receivers and Transmitters," *IEEE Journal of Selected Topics in Quantum Electronic*, vol. 20, no. 4, pp. 150-157, 2014.
- [65] P. Chowdhury, M. Tornatore, B. Mukherjee, "On the Energy Efficiency of Mixed-Line-Rate Networks," *Optical Fiber Communication Conference (OFC/NFOEC)* , paper OWY3, Mar. 2010.
- [66] W.V. Heddeghem, M.D. Groote, W. Vereecken, D. Colle, M. Pickavet, and P. Demeester, "Energy efficiency in Telecommunication networks: Link-by-Link versus End-to-End Grooming," *Optical Network Design and Modeling (ONDM) 2010*, Feb. 2010.
- [67] A. Muhammad, P. Monti, I. Cerutti, L. Wosinska, P. Castoldi, and A. Tzanakaki, "Energy-Efficient WDM Network Planning with Dedicated Protection Resources in Sleep Mode," in *IEEE Global Telecommunications Conference (GLOBECOM)*, pp. 1–5, Dec. 2010.
- [68] X. Dong, T. El-gorashi, and J. M. H. Elmirghani, "On the energy efficiency of physical topology design for IP over WDM networks," *Journal of Lightwave Technology*, vol. 30,no. 12, pp. 1931-1942, 2012.
- [69] F. Idzikowski, E. Bonetto, L. Chiaraviglio, A. Cianfrani, A. Coiro, R. Duque, F. Jiménez, E. Le Rouzic, F. Musumeci, W. Van Heddeghem, J. López Vizcaíno, Y. Ye, "TREND in energy-aware adaptive routing solutions," *IEEE Communications Magazine*, vol.51, no.11, pp.94,104, November 2013.
- [70] K. Kvaternik, J. Llorca, D. Kilper, L. Pavel, "Decentralized caching strategies for energy-efficient content delivery," *IEEE International Conference on Communications (ICC)*, vol., no., pp.3707, 3713, June 2014.
- [71] B. St. Arnaud, "CANARIE: Research networks to help reduce global warming," *OFC Workshop on Energy Footprint of ICT: Forecast and Network Solutions*, Mar. 2009.
- [72] M. Boddie, T. Schondienst, V. M. Vokkarane. "Dual power source aware algorithms for green optical network survivability," *IEEE Online Conference on Green Communications (GreenCom)*, pp. 32-37. 2012.
- [73] G. Shen and R.S. Tucker, "Energy-Minimized Design for IP Over WDM Networks," *Journal of Optical Communications and Networking*, vol. 1, pp. 176-186, Jun. 2009.
- [74] J. Mata, Y. Ye, J. López Vizcaíno, "Embodied and operational energy optimization for improved energy efficiency in transport networks," *16th International Conference on Transparent Optical Networks (ICTON)*, pp.1-4, July 2014.
- [75] X. Dong, A. Lawey, T.E.H. El-Gorashi, J.M.H. Elmirghani, "Energy-efficient core networks," *16th International Conference on Optical Network Design and Modeling (ONDM)*, pp.1,9, April 2012.
- [76] DE-CIX Frankfurt statistics, <https://www.de-cix.net/about/statistics/>, accessed on 1 November 2014.
- [77] P. Chowdhury, M. Tornatore, A. Nag, E. Ip, T. Wang, and B. Mukherjee, "On the design of energy-efficient Mixed-Line-Rate (MLR) optical networks," *Journal of Lightwave Technology*, vol. 30, no. 1, pp. 130–139, Jan. 2012.
- [78] A. Nag, M. Tornatore, and B. Mukherjee, "Energy-efficient and cost-efficient capacity upgrade in mixed-line-rate optical networks," *IEEE Journal of Optical Communications and Networking*, vol. 4, no. 12, pp. 1018–1025, Dec.2012.
- [79] J. López Vizcaíno, Y. Ye, and I. Tafur Monroy, "Energy Efficiency in Elastic-Bandwidth Optical Networks," *International Conference on the Network of the Future (NOF)*, vol., no., pp.107,111, 28-30 Nov. 2011.

- [80] J. López Vizcaíno, Y. Ye, and I. Tafur Monroy, "Energy efficiency analysis for flexible-grid OFDM-based optical networks," *Computer Networks*, Vol. 56, pp. 2400-2419, July 2012.
- [81] E. Palkopoulou, M. Angelou, D. Klonidis, K. Christodoulopoulos, A. Klekamp, F. Buchali, E. Varvarigos, I. Tomkos, "Quantifying spectrum, cost, and energy efficiency in fixed-grid and flex-grid networks [Invited]," *IEEE/OSA Journal of Optical Communications and Networking*, vol.4, no.11, pp.B42,B51, Nov. 2012.
- [82] M. Angelou, K. Christodoulopoulos, D. Klonidis, A. Klekamp, F. Buchali, E. Varvarigos, and I. Tomkos, "Spectrum, cost and energy efficiency in fixed-grid and flex-grid networks," *Optical Fiber Communication Conference and Exposition and the National Fiber Optic Engineers Conference (OFC/NFOEC)*, vol., no., pp.1,3, 4-8 March 2012, Mar. 2012.
- [83] A. Nag, T. Wang, and B. Mukherjee, "Robust design of spectrum-efficient green optical backbone networks," *Journal of Lightwave Technology*, vol. 31, no. 7, pp. 1138-1144, Apr. 2013.
- [84] Y. Wu, W. Hou, L. Guo, Y. Liu, and Z. Sun, "Green Grooming in Elastic Optical Networks," *Optical Fiber Communication Conference and Exhibition (OFC)*, pp. W3A-3. paper W3A.3, 2014.
- [85] H. Khodakarami, B.S.G. Pillai, B. Sedighi, B.; Shieh, W., "Flexible Optical Networks: An Energy Efficiency Perspective," *Journal of Lightwave Technology*, vol.32, no.21, pp.3356-3367, Nov. 2014.
- [86] A. Klekamp, U. Gebhard, and F. Ilchmann, "Efficiency of Adaptive and Mixed-Line-Rate IP Over DWDM Networks Regarding CAPEX and PC [Invited]," *IEEE/OSA Journal of Optical Communications and Networking*, vol.4, no.11, pp.B11,B16, Nov. 2012.
- [87] A. Klekamp, U. Gebhard, and F. Ilchmann, "Energy and cost efficiency of adaptive and mixed-line-rate IP over DWDM networks," *Journal of Lightwave Technology*, vol. 30, no. 2, pp. 215-221, 2012.
- [88] A. Klekamp, U. Gebhard, and F. Ilchmann, "Efficiency of adaptive and mixed-line-rate IP over DWDM networks regarding CAPEX and PC," *Optical Fiber Communication Conference and Exposition and the National Fiber Optic Engineers Conference (OFC/NFOEC)*, vol., no., pp. 1-3, Mar. 2012.
- [89] A. Ahmad, A. Bianco, E. Bonetto, "Traffic Grooming and Energy efficiency in Flexible-Grid Networks", *IEEE International Conference on Communications (ICC)*, vol., no., pp.3264,3269, June 2014.
- [90] X. Dong, T.E.H El-Gorashi, J.M.H Elmirghani, "Energy efficiency of optical OFDM-based networks," *IEEE International Conference on Communications (ICC)*, 2013, vol., no., pp.4131-4136, June 2013.
- [91] J. Mata, Y. Ye, J. Lopez Vizcaino, I. Tafur Monroy, "Influence of embodied energy in the energy efficiency of optical transport networks," *39th European Conference and Exhibition on Optical Communication (ECOC)*, vol., no., pp.1,3, Sept. 2013
- [92] J. López Vizcaíno, Y. Ye, I. Tafur Monroy, "Energy efficiency analysis for dynamic routing in optical transport networks," *IEEE International Conference on Communications (ICC)*, vol., no., pp.3009-3014, June 2012.
- [93] A. Fallahpour, H. Beyranvand, S. A. Nezamalhosseini, J. A. Salehi, "Energy Efficient Routing and Spectrum Assignment With Regenerator Placement in Elastic Optical Networks," *Journal of Lightwave Technology*. vol. 32, no. 10, pp. 2019-2027, 2014.
- [94] A. Morea, O. Rival, N. Brochier, E. Le Rouzic, "Data rate Adaptation for Night-Time Energy Savings in Core Networks," *Journal of Lightwave Technology*, vol.31, no.5, pp.779-785, March, 2013.
- [95] S. Zhang, B. Mukherjee, "Energy-efficient dynamic provisioning for spectrum elastic optical networks," *IEEE International Conference on Communications (ICC)*, vol., no., pp.3031-3035, June 2012.
- [96] J. López Vizcaíno, "Energy Efficiency in Optical Transport Networks," *MSC Thesis at the Technical University of Denmark (DTU)*, September 2011.
- [97] J. López Vizcaíno, Y. Ye, V. López, F. Jiménez, R. Duque, I. Tafur, Peter M. Krummrich, "Green Networking and Communications: ICT for Sustainability," Chapter 17-Energy Efficiency Improvement with the Innovative Flexible-grid Optical Transport Network, Auerbach Publications- CRC Press, Taylor & Francis Group, ISBN: 978-1-4665-6874-7, Nov. 2013.
- [98] C. Dorize, W. Van Heddeghem, F. Smyth, E. Le Rouzic, B. Arzur, "GreenTouch Draft Report on Baseline PC," Version 1.8, Nov. 2011.
- [99] S.J. Savory, "Digital Signal Processing Options in Long Haul Transmission," *Optical Fiber communication/National Fiber Optic Engineers Conference (OFC/NFOEC)*, pp. OTuO3, Feb. 2008.
- [100] European Union Seventh Framework Programme DICONET project, "Deliverable: D.2.1: Definition of dynamic optical network architectures," Sep. 2010.
- [101] F Idzikowski, E Bonetto, Ł Budzisz, L Chiaraviglio, A Cianfrani, A Coiro, R Duque, W Van Heddeghem, F Jiménez, J López Vizcaíno, F Matera, I Monroy, F Musumeci, A Pattavina, E Le Rouzic, A Valenti, Y Ye, "Final report for the IRA Energy-efficient use of network core resources." *Eu Seventh Framework Programme TREND project Deliverable D3.3*, 2012.
- [102] A. Eira, J. Pedro, J. Pires, D. Fonseca, J. Fernández-Palacios, V. López, S. Spaelter, "Defragmentation-based capacity enhancement for fixed to flexible-grid migration scenarios in DWDM networks," *39th European Conference and Exhibition on Optical Communication (ECOC 2013)*, vol., no., pp.1,3, Sept. 2013.

- [103] A. Eira, J. Pedro, J. Pires, "On the impact of optimized guard-band assignment for superchannels in flexible-grid optical networks," Optical Fiber Communication Conference and Exposition and the National Fiber Optic Engineers Conference (OFC/NFOEC), pp. OTu2A-5, Mar. 2013.
- [104] ARD / ZDF, "Online Study 2012 Internet Usage in Germany 2012", http://www.ard-zdf-onlinestudie.de/fileadmin/Online12/0708-2012_Eimeren_Frees.pdf, accessed on Jan. 2013.
- [105] Y. Ye, F. Jiménez Arribas, J. Elmirghani, F. Idzikowski, J. López Vizcaíno, P. Monti, F. Musumeci, A. Pattavina, W. Van Heddeghem, "Energy-efficient resilient optical networks: Challenges and trade-offs," IEEE Communications Magazine, vol.53, no.2, pp.144,150, Feb. 2015
- [106] C. Cavdar, F. Buzluca, L. Wosinska, "Energy-Efficient Design of Survivable WDM Networks with Shared Backup," IEEE Global Telecommunications Conference (GLOBECOM), pp. 1–5, Dec. 2010.
- [107] F. Musumeci, M. Tornatore, J. López Vizcaíno, Y. Ye, A. Pattavina, "Power-aware design of protected IP-over-WDM Networks with sleep-mode devices," IEEE Online Conference on Green Communications (GreenCom), pp.20,25, 25-28 Sept. 2012.
- [108] F. Musumeci, M. Tornatore, J. López Vizcaíno, Y. Ye, and A. Pattavina, "Energy efficiency of Protected IP-over-WDM Networks with Sleep-mode Devices," Journal of High Speed Networks, vol. 19, no. 1, pp. 19–32, 2013.
- [109] S.S. Jalalinia, C. Cavdar, L. Wosinska, "Survivable green optical backbone networks with shared path protection," Optical Fiber Communication Conference and Exposition and the National Fiber Optic Engineers Conference (OFC/NFOEC), pp. OM2G-3, Mar. 2012.
- [110] N.-H. Bao, L.-M. Li, H.-F. Yu, Z.-Z. Zhang, and H.-B. Luo, "Power-aware provisioning strategy with shared path protection in optical WDM networks," Optical Fiber Technology, vol. 18, no. 2, pp. 81–87, Mar. 2012.
- [111] P. Monti, A. Muhammad, I. Cerutti, and C. Cavdar, "Energy-Efficient Lightpath Provisioning in a Static WDM Network with Dedicated Path Protection," 13th International Conference on Transparent Optical Networks (ICTON), June 2011.
- [112] A. Jirattigalachote, C. Cavdar, P. Monti, L. Wosinska, and A. Tzanakaki, "Dynamic provisioning strategies for energy efficient WDM networks with dedicated path protection," Optical Switching and Networking, vol. 8, no. 3, pp. 201–213, July 2011.
- [113] A. Muhammad, P. Monti, I. Cerutti, L. Wosinska, P. Castoldi, "Reliability Differentiation in Energy Efficient Optical Networks with Shared Path Protection," IEEE Online Conference on Green Communication (Greencom), pp. 64-69, Oct. 2013.
- [114] X. Chen, F. Ji, Z. Zhu, "Energy-efficient protection designs for translucent optical networks using mixed regenerator placement," Optical Fiber Communication Conference and Exposition and the National Fiber Optic Engineers Conference (OFC/NFOEC), pp. JTh2A-63, Mar. 2013.
- [115] X. Chen, F. Ji, Y. Wu, Z. Zhu, "Energy-efficient resilience in translucent optical networks with mixed regenerator placement," IEEE/OSA Journal of Optical Communications and Networking, vol.5, no.7, pp.741,750, July 2013.
- [116] Z. Zhu, X. Chen, F. Ji, L. Zhang, F. Farahmand, J.P. Jue, "Energy-Efficient Translucent Optical Transport Networks With Mixed Regenerator Placement," Journal of Lightwave Technology, vol.30, no.19, pp.3147,3156, Oct. 2012.
- [117] X. Zhang, H. Wang, Z. Zhang, "Survivable green IP over WDM networks against double-link failures," Computer Networks, vol. 59, 11 pp. 62-76, Feb. 2014.
- [118] X. Shao, L. Zhou, Y. Kee Yeo, T. Yoong Chai, L. Heng Ngoh, W. Rong, X. Cheng, Y. Wang, C. Yi Liaw, J. Samsudin, "Differentiated Quality of Protection (QoP) and Cross-Layer Protection for Survivable Hybrid Packet/WDM Networks," Optical Fiber Communication Conference (OFC), pp. OThP6, Mar. 2009.
- [119] X. Shao, L. Zhou, W. Zheng and Y. Wang, "Providing Differentiated Quality-of-Protection for Surviving Double-Link Failures in WDM Mesh Networks," IEEE International Conference on Communications (ICC) 2007, pp.2180-2185, Jun. 2007.
- [120] The Ethernet Academy Articles, "Putting 50-ms in Perspective," <http://www.ethernetacademy.net/index.php/2008112983/Ethernet-Academy-Articles/puting-50-milliseconds-in-perspective.html>, accessed in Sep. 2014.
- [121] J. López Vizcaíno, P. Soto, Y. Ye, and P. M. Krummrich, "Differentiated quality of protection: An energy-and spectral-efficient resilience scheme for survivable static and dynamic optical transport networks with fixed-and flexible-grid," Optical Switching and Networking, 2015.
- [122] A. Minagar, M. Premaratne, A. Tran, "Cost optimal allocation of amplifiers and DCMs in WDM ring networks," Opt. Express, vol. 14, no. 2, 2006.
- [123] W. Xie, Y. Zhu, J.P. Jue, "Energy-efficient impairment-constrained 3R regenerator placement in optical networks," IEEE International Conference on Communications (ICC), 2012, vol., no., pp.3020-3024, June 2012.
- [124] L. Zhong, B. Ramamurthy, "Optimization of amplifier placements in switch-based optical networks," IEEE International Conference on Communications (ICC) 2001, vol.1, no., pp.224,228, Jun. 2001.
- [125] A.V Tran, R. Tucker, N.L. Boland, "Amplifier placement methods for metropolitan WDM ring networks," Journal of Lightwave Technology, vol.22, no.11, pp.2509,2522, Nov. 2004.

- [126] G. Shen, W. Shao, L. Peng, "Green optical channel layer design with minimum use of optical amplifiers and fibers," 10th International Conference on Optical Communications and Networks (ICOCN 2011), vol., no., pp.1-2, 2011.
- [127] A. Coiro, M. Listanti, A. Valenti, F. Matera, "Reducing PC in Wavelength Routed Networks by Selective Switch Off of Optical Links," IEEE Journal of Selected Topics in Quantum Electronics, , vol.17, no.2, pp.428,436, March-April 2011.
- [128] P. Wiatr, J. Chen, P. Monti, L. Wosinska, "Energy Efficiency and Reliability Tradeoff in Optical Core Networks," Optical Fiber Communication Conference (OFC), pp. Th4E.4, Mar. 2014.
- [129] A. Mitra, A. Lord, S. Kar, P. Wright, S. Desbruslais, "Upgrading to low loss ROADMs and additional line amplifiers for increased capacity in EDFA and Raman flexgrid networks," European Conference on Optical Communication (ECOC), vol., no., pp.1,3, 21-25 Sep. 2014.
- [130] M.F. Huang, S. Zhang, K. Mino, Y. Aono, "Transmission of 400G Dual-Carrier DP-16QAM and Multi-Carrier DP-QPSK Signals over Regional and Long-Haul Distances with Span Lengths Greater than 200 km," Optical Fiber Communication Conference (OFC), pp. Th4F-3, Mar. 2014.
- [131] Cisco, Product datasheet of Cisco 40G CP-QPSK, <http://www.cisco.com/web/CA/events/pdfs/CNSF2011-Foundation-for-Next-Generation-Transport-Ramesh-Pillutla.pdf> , accessed in May 2013.
- [132] Juniper, Product datasheet of Juniper 2-port 100G DWDM PTX PIC, <http://www.juniper.net/us/en/local/pdf/datasheets/1000429-en.pdf>, accessed in May 2013.
- [133] Cisco, Product datasheet of Cisco ONS 15454 100 Gbps Coherent DWDM Trunk Card, http://www.cisco.com/en/US/prod/collateral/optical/ps5724/ps2006/data_sheet_c78-713298.pdf, accessed in May 2013.
- [134] B. Collings, "FlexGrid technologies," European Conference on Optical Communications (ECOC) workshop WS08-Beyond 100G- Technology Options. Sep. 2012.
- [135] JDSU, White paper, "Building a fully flexible optical layer with next-generation ROADM," <http://www.jdsu.com/productliterature/hr-roadm-2011-final.pdf>, accessed in May 2013.
- [136] Finisar, Finisar datasheet of Finisar DWPf WSS with FlexGrid functionality, http://www.finisar.com/sites/default/files/pdf/DWPfpercent20Productpercent20Briefpercent209_2011percent20V6.pdf accessed in May 2013.
- [137] B. Chomycz, "Planning Fiber Optics Networks," McGraw-Hill, ISBN: 9780071818674, Chapter 3 and Appendix B, 2009.
- [138] F. Jiménez, European Seventh Framework IDEALIST project, "WP1 preliminary inputs for WP2 analysis," 2012.
- [139] S. Ramamurthy, L. Sahasrabudde, B. Mukherjee, "Survivable WDM mesh networks," Journal of Lightwave Technology, vol.21, no.4, pp.870,883, April 2003.

