

Numerical Simulation of Magnetic Pulse Welding: Insights and Useful Simplifications

J. Körner, G. Göbel, B. Brenner, E. Beyer

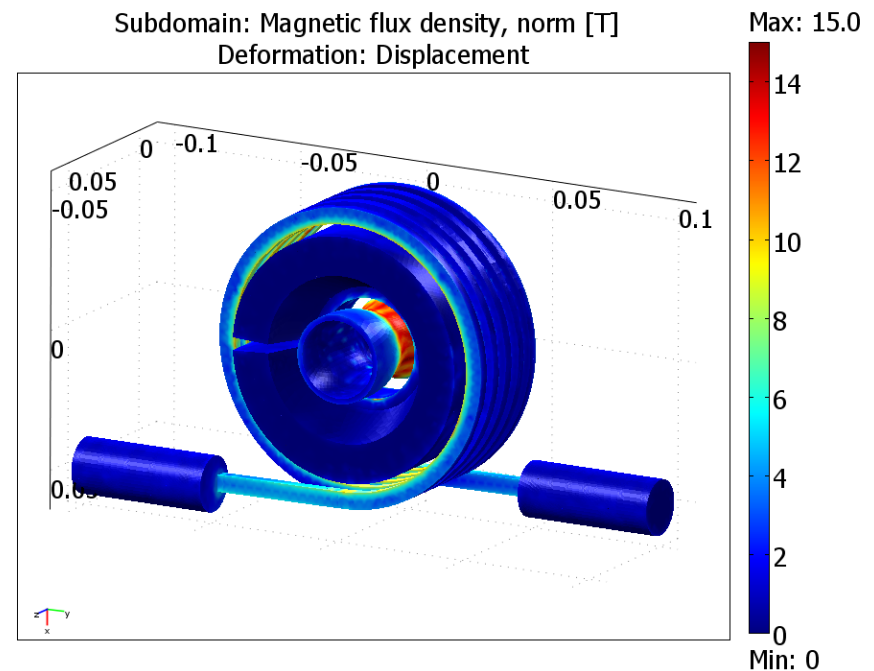
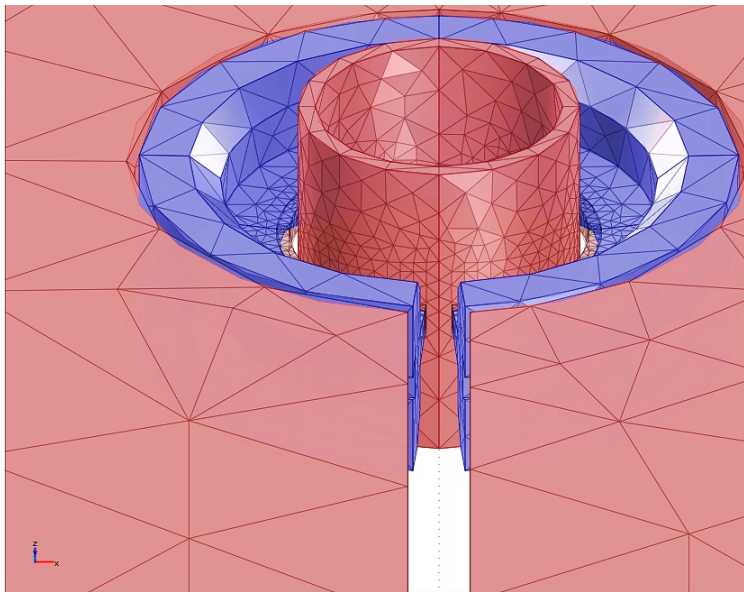

Content

1. Magnetic Pressure Evaluation

1.1 Model

1.2 Electric Result

1.3 Magnetic Result

2. Timeharmonic vs. Transient Calculation

3. The Influence of Meshing

3.1 Model

3.2 Calculation Time and Variation in Currents

4. Conclusions

Insights and Useful Simplifications



**Hidden aspects
of Magnetic
Pulse Welding**



Fast. Accurate. Easy.

**Manner of
calculation**

**Minimal
simulation time**

**Optimized
meshing**

1.1 Model

Model consists of:

- Flat coil with one turn
- Field shaper
- Tubular workpiece

Boundary conditions:

- Right port: Ground
- Left port: Potential

$$U(t) = 2.5 \cdot 10^3 \cdot \cos(2\pi \cdot 10^3 \cdot t) \cdot e^{-7000 \cdot t}$$

Calculation Method:

Comsol Multiphysics

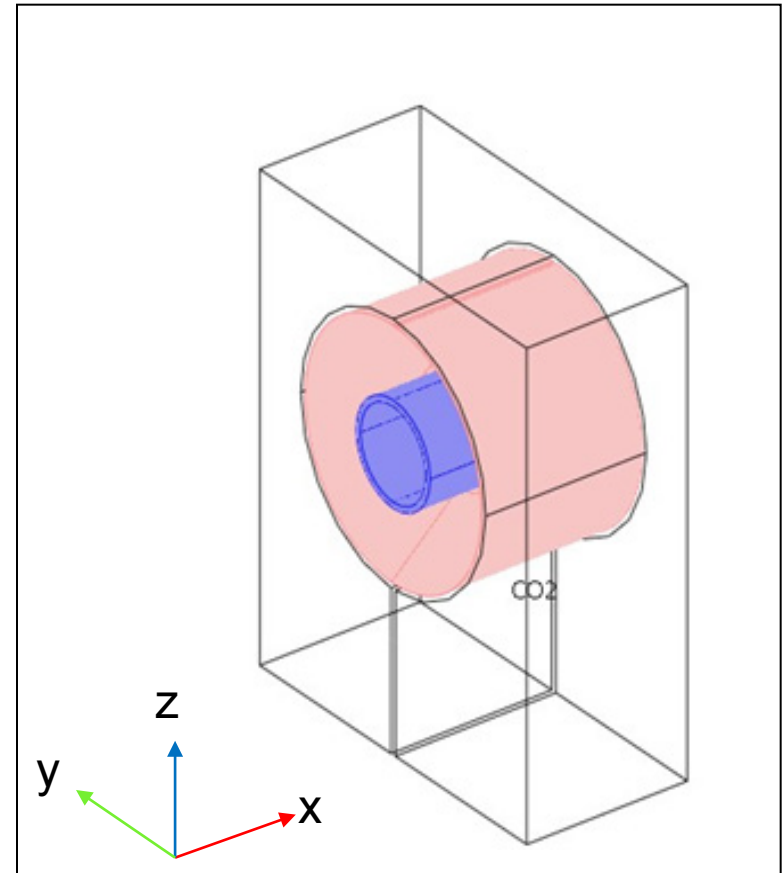

1.2 Electric Result: Current in coil

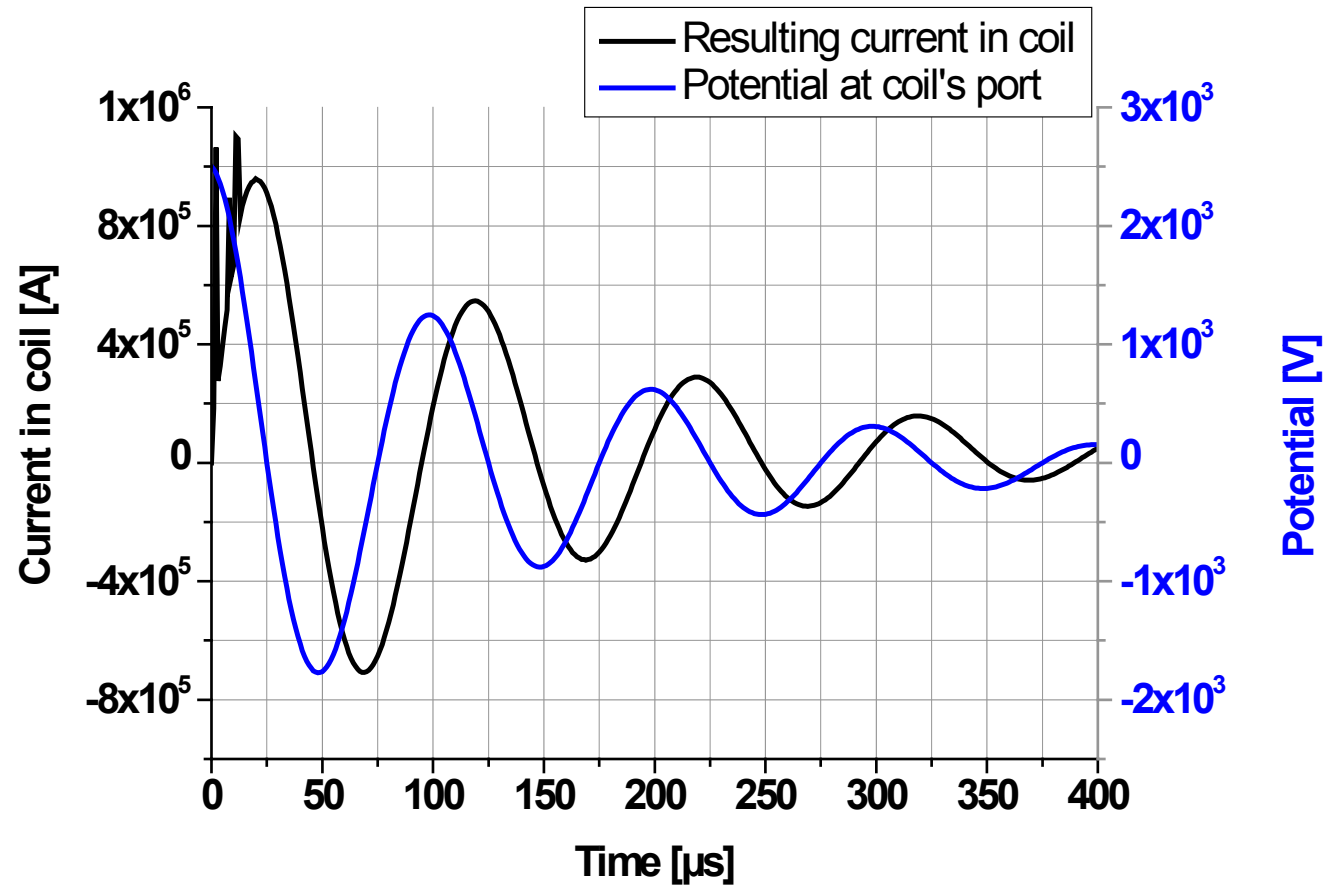
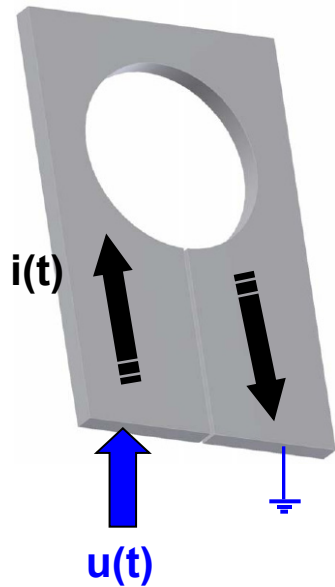

1.3 Magnetic Result: Magnetic pressure in workpiece

$$p(t) = \frac{1}{2 \cdot \mu_0} \cdot (B(t))^2$$

- Radially from all directions onto the workpiece
- Difference in pressure on the **inside** and **outside** of the workpiece

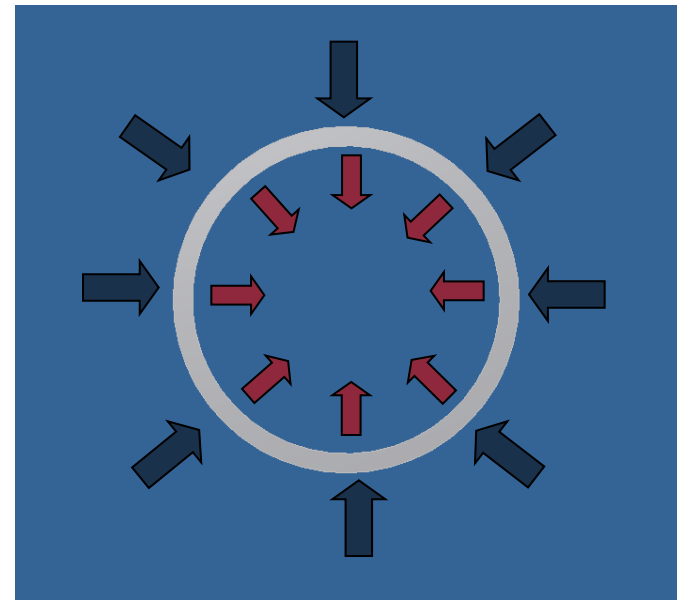
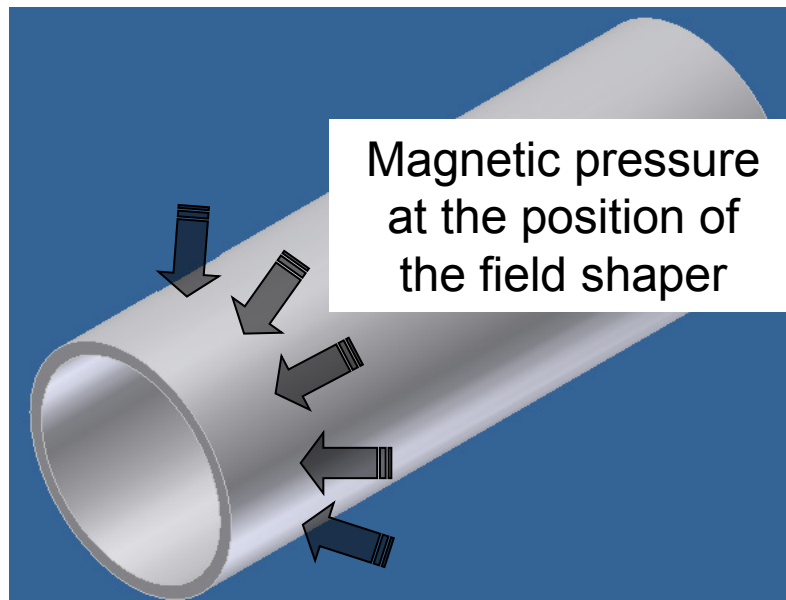

1. Magnetic Pressure Evaluation

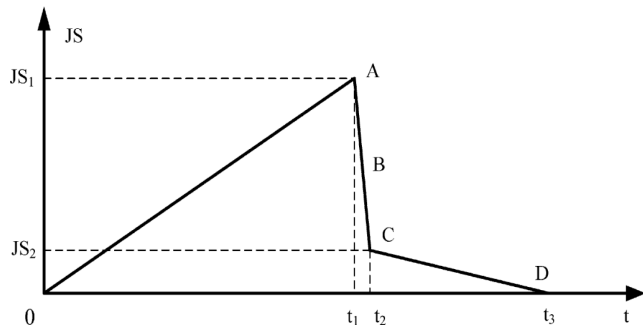
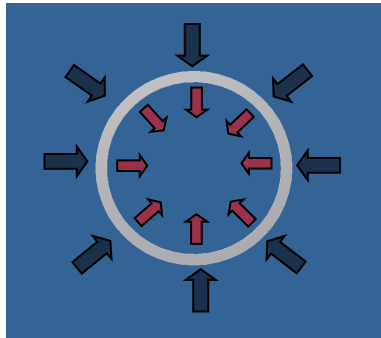

Deng et al: Numerical simulation of magnetic flux and force in electromagnetic forming with attractive force

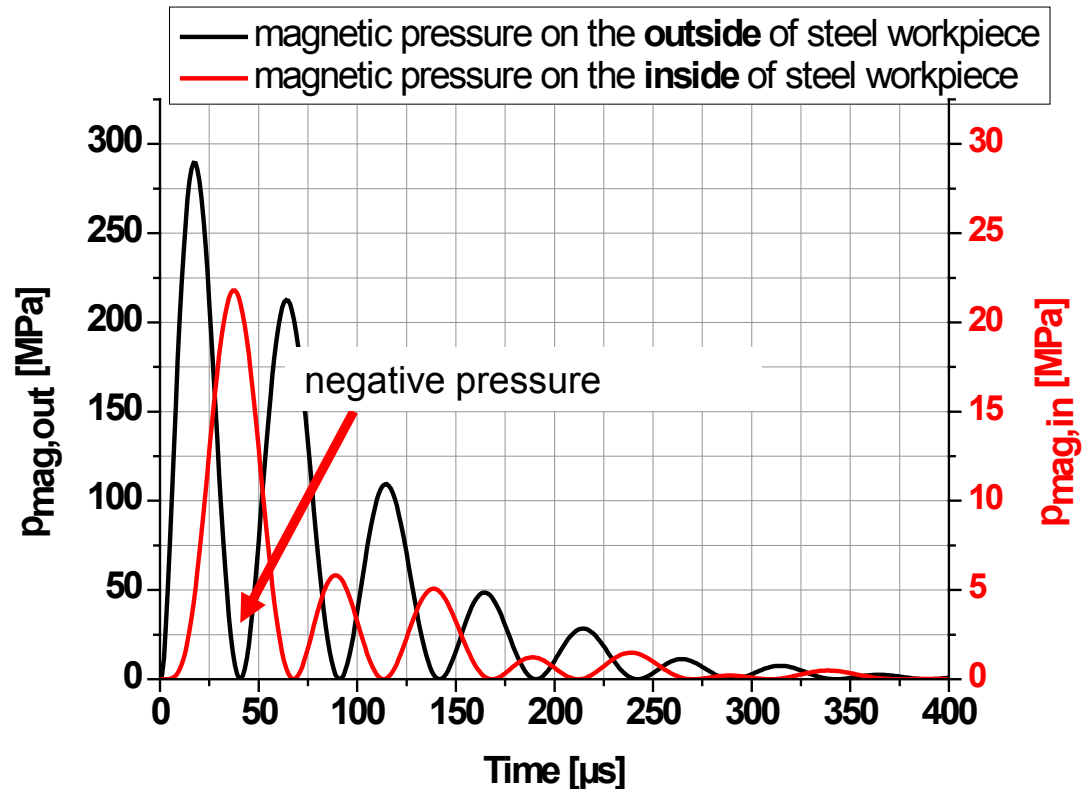

- The resulting difference in the magnetic pressure is the quantity which deforms the workpiece
- Small negative amount due to the phase shift between inner and outer pressure evolution → most significant in the first period

1. Magnetic Pressure Evaluation

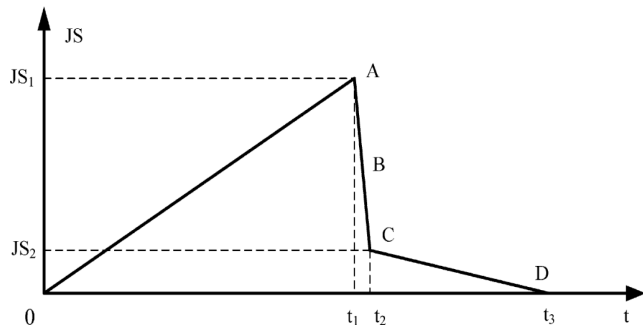
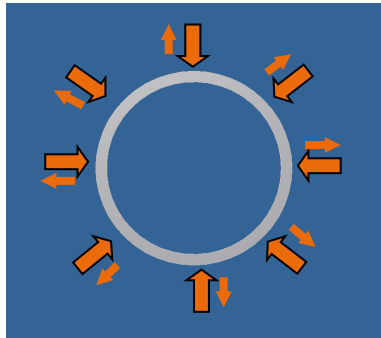

Deng et al: Numerical simulation of magnetic flux and force in electromagnetic forming with attractive force

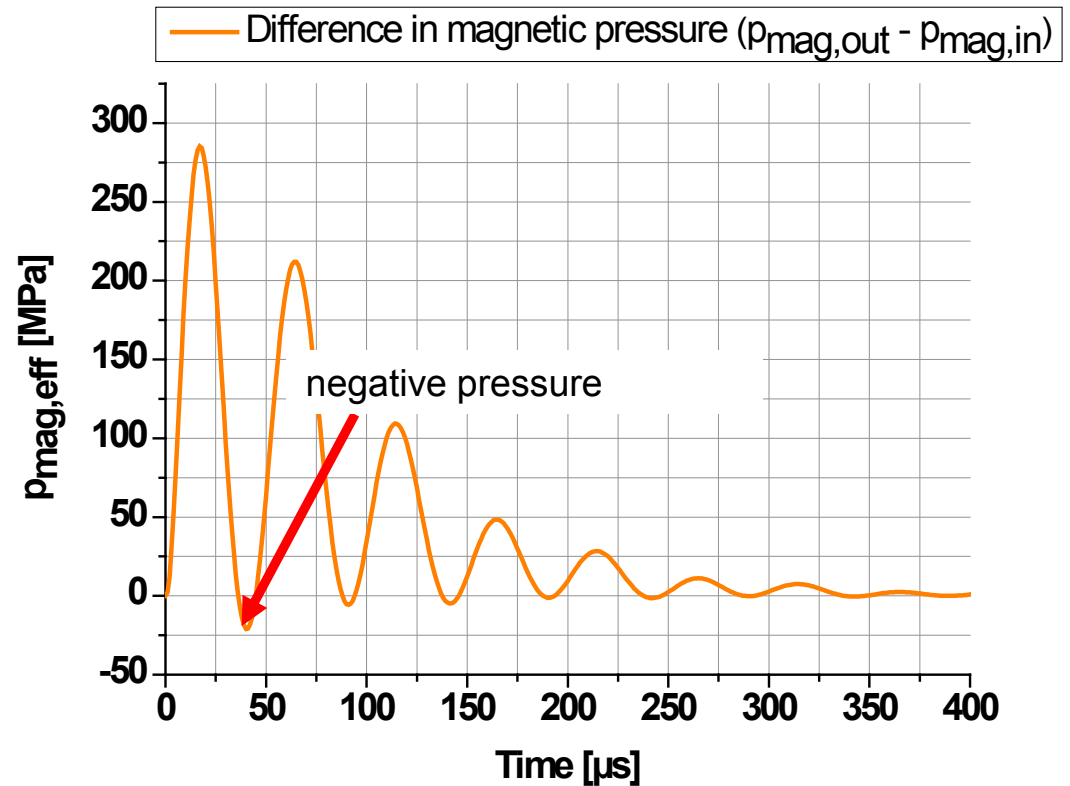

- The resulting difference in the magnetic pressure is the quantity which deforms the workpiece
- Small negative amount due to the phase shift between inner and outer pressure evolution → most significant in the first period

Insights and Useful Simplifications

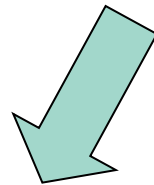

Hidden aspects of
Magnetic Pulse
Welding



Fast. Accurate. Easy.

**Manner of
calculation**

**Minimal
simulation time**

**Optimized
meshing**

2. Transient vs. Time-Harmonic Calculation

Transient

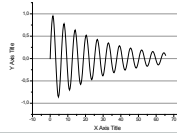

- Differential equations solved for each predefined time-step
- Arbitrary excitation function

Time-harmonic

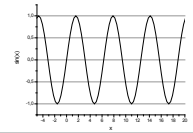

- System only solved once
- Excitation function approximated as a continuous sine wave

Initial conditions

- All parameters equal zero

- Continuous process

Advantages / Disadvantages

- + Accurate solution
- Time-consuming

- + Fast
- May disregard highly transient aspects at the beginning of a pulse

2. Transient vs. Time-Harmonic Calculation

2.1 Comparison of currents

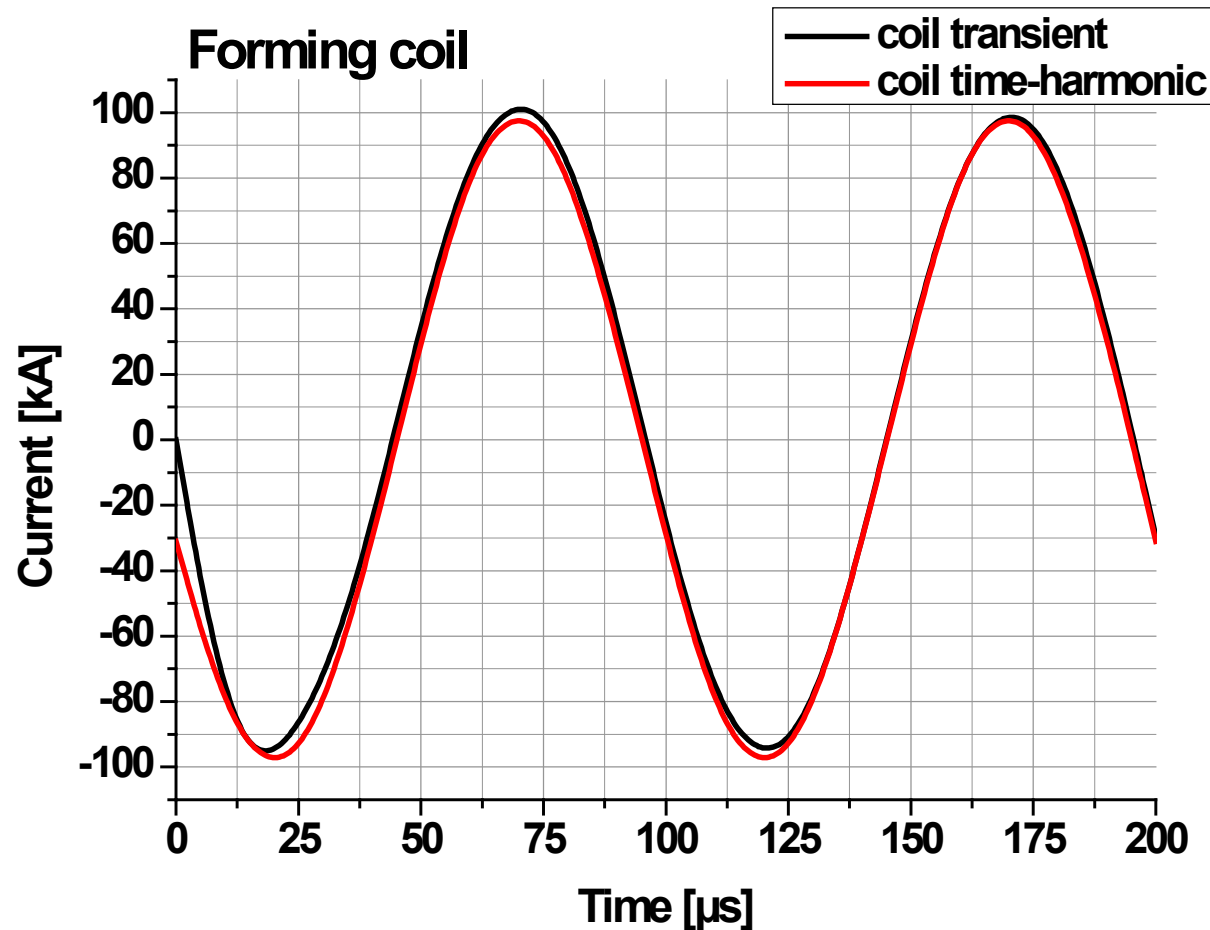

- No significant error
- Fast time-harmonic approach applicable

Is this assumption always correct?

2. Transient vs. Time-Harmonic Calculation

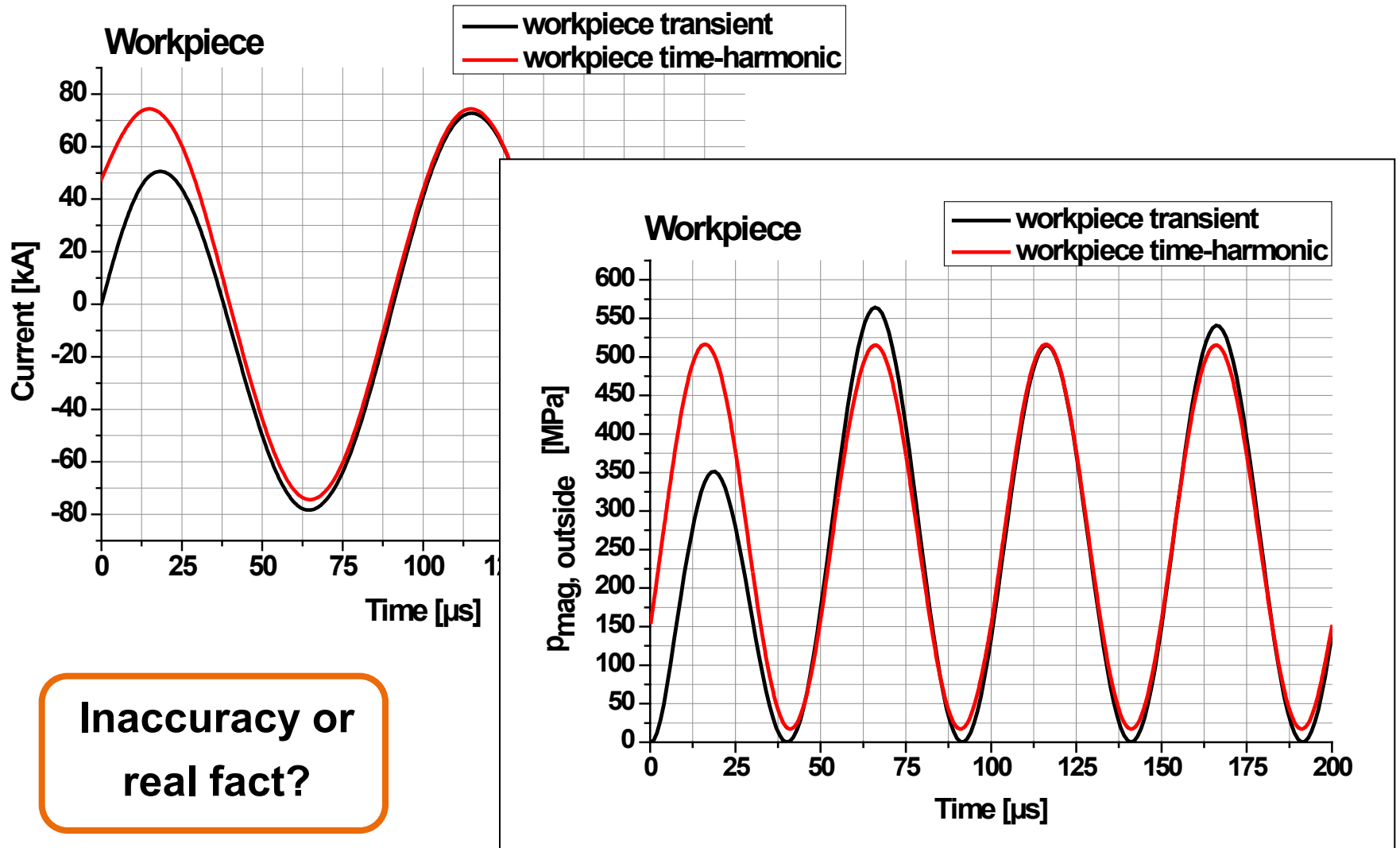

**Inaccuracy or
real fact?**

2.2 Idea: Analytical description for the workpiece

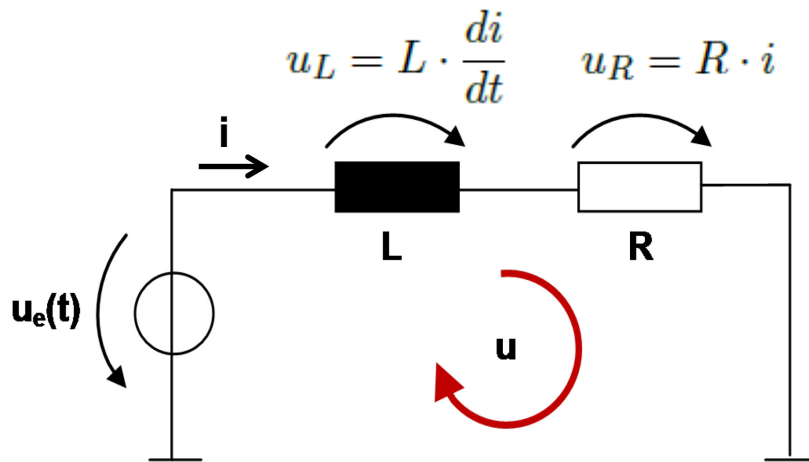

$$u_e(t) = 0 \quad t < 0$$

$$u_e(t) = U_0 \cdot \cos(\omega t) \quad t \geq 0$$

$$-u_e + u_L + u_R = 0$$

$$\dot{i} + \frac{R}{L} \cdot i = \frac{u_e(t)}{L}$$

Solution of differential equation

$$i(t) = \underbrace{K \cdot e^{-\frac{t}{\tau}}}_{\text{Transient}} + \underbrace{I_0 \cdot \sin(\omega \cdot t + \varphi_I)}_{\text{Steady-state}}$$

2. Transient vs. Time-Harmonic Calculation

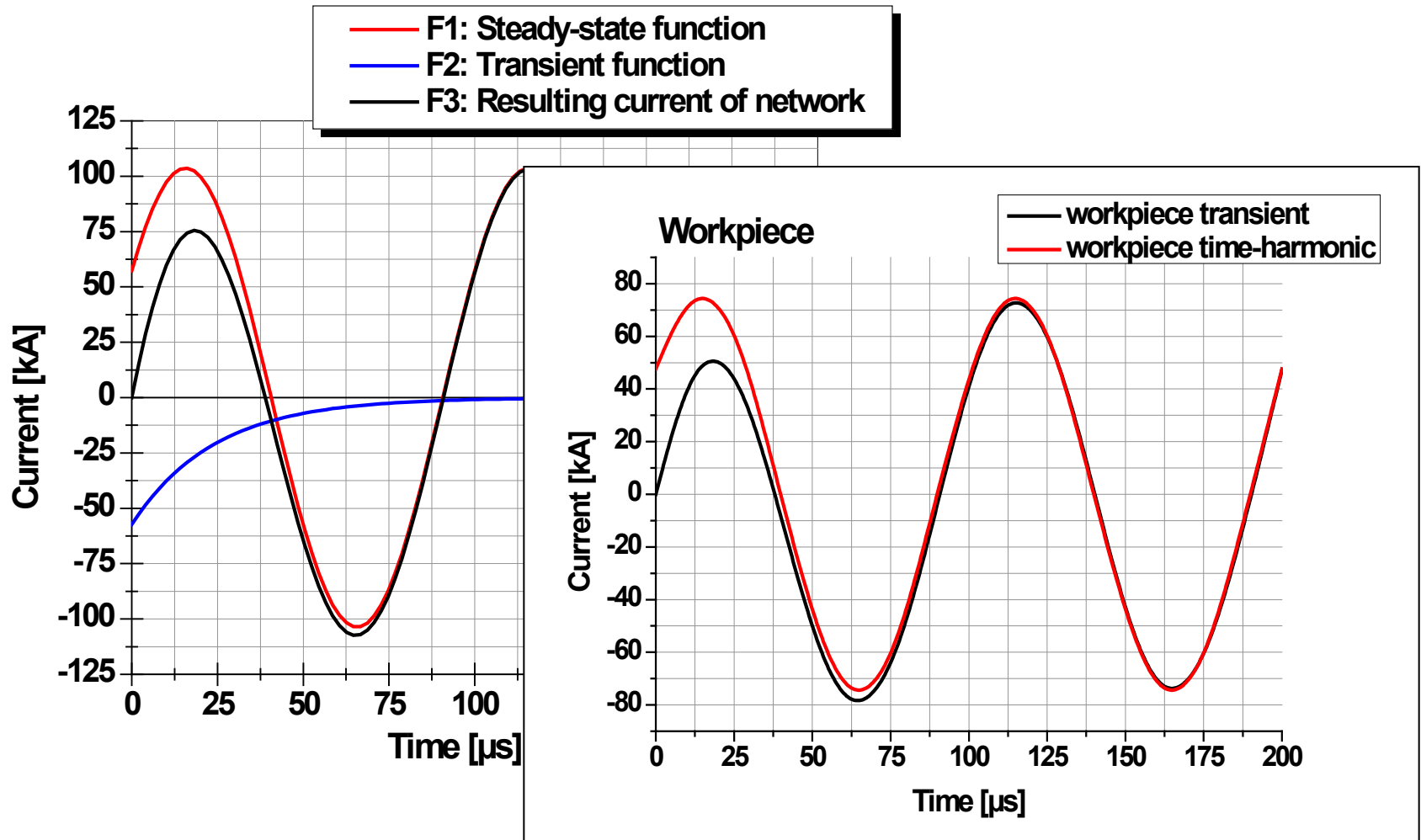

3.1 Model

- Flat coil with one turn
- 2 planes were inserted for the meshing simulation

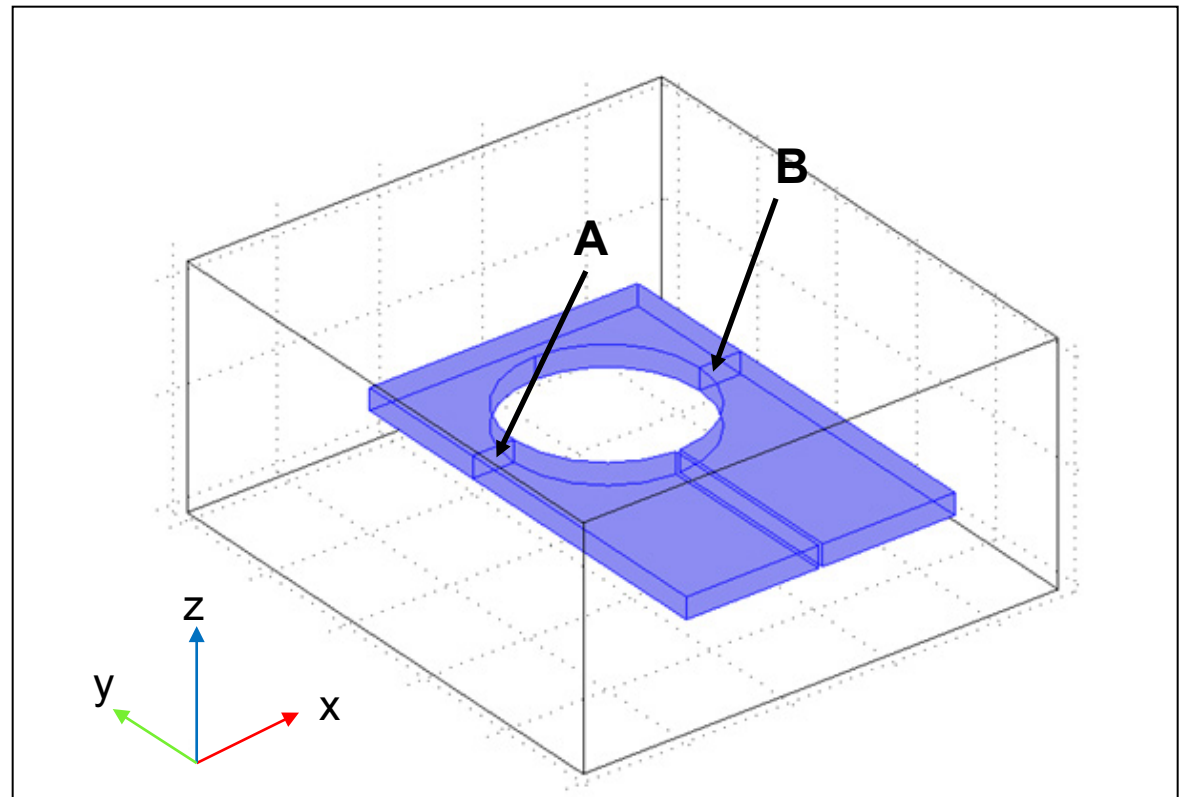

3.2 Calculation time and variation of currents

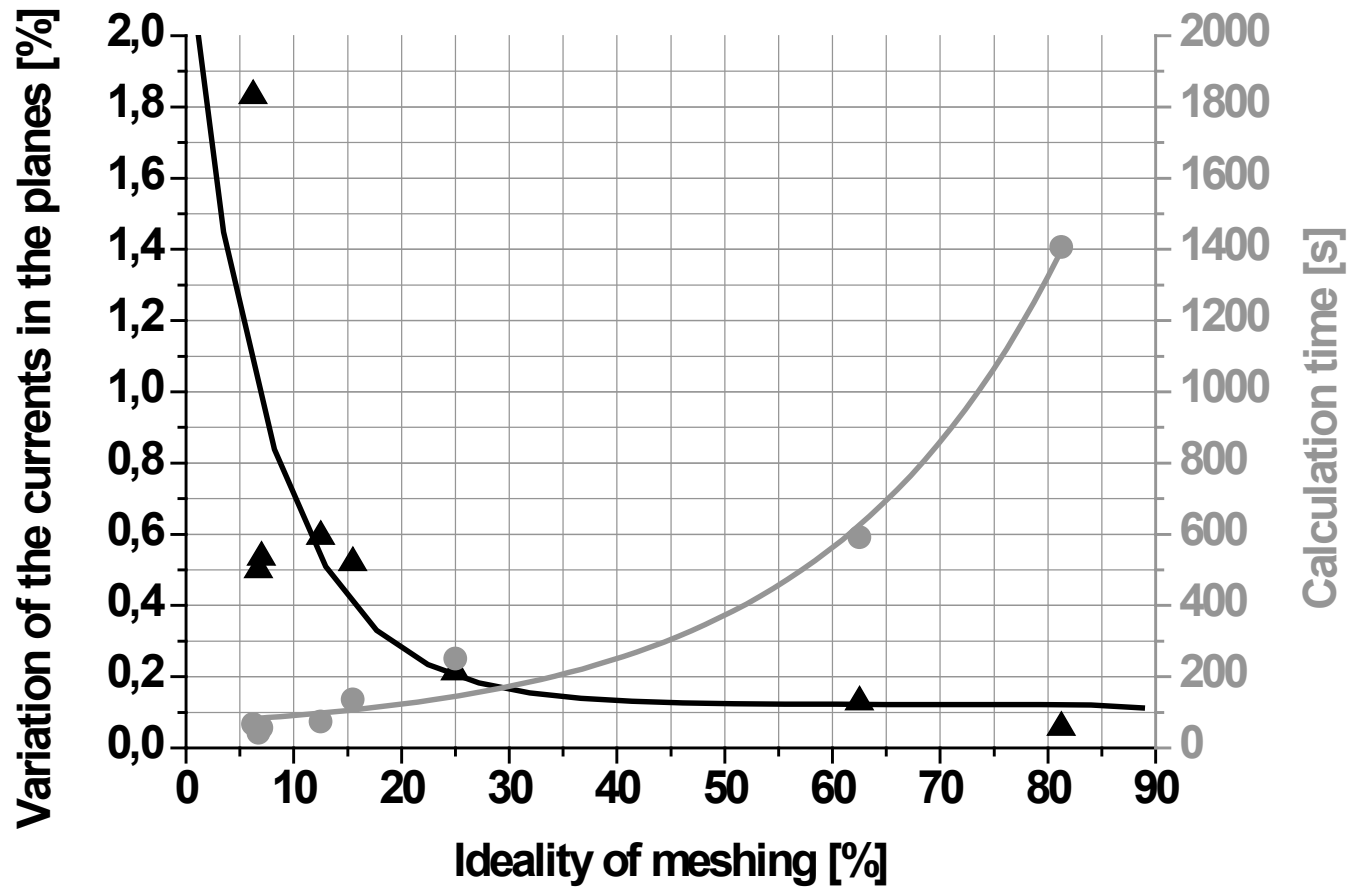

- Negative parts of the magnetic pressure visible
 - Dependent on material and frequency
 - Influenced by adjusting forming current

- Time-harmonic calculations: fast and fairly accurate in some cases
 - Knowledge about highly transient aspects necessary

- Only one mesh element per skin depth sufficient
 - For a certain geometry
 - Significant reduction of calculation time

Thank you for your attention!

From the COMSOL website:

The COMSOL Multiphysics *engineering simulation software* environment facilitates all steps in the modeling process – defining your geometry, meshing, specifying your physics, solving, and then visualizing your results.

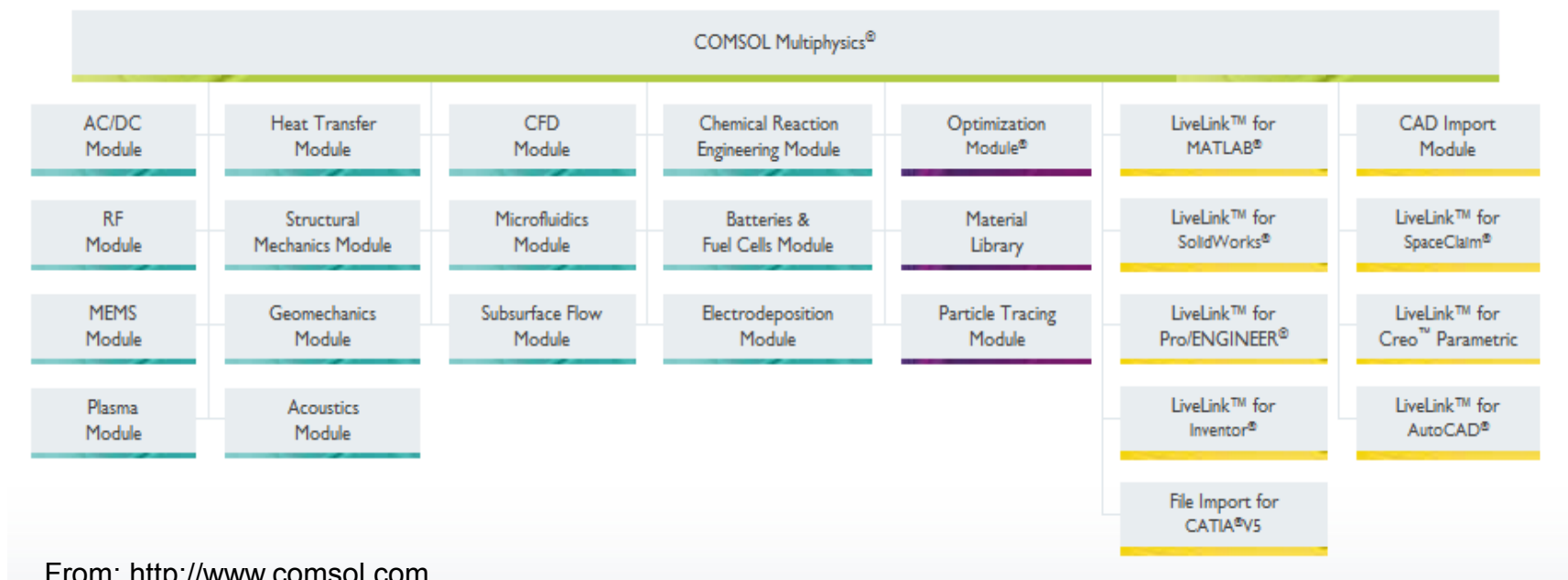

Deng: Numerical simulation of magnetic flux and force in electromagnetic forming with attractive force

“[...] In this paper, the principle of electromagnetic attractive force forming is proposed and the effect of the discharge current wave-form on the direction of magnetic force acting on the workpiece is discussed. [...]”

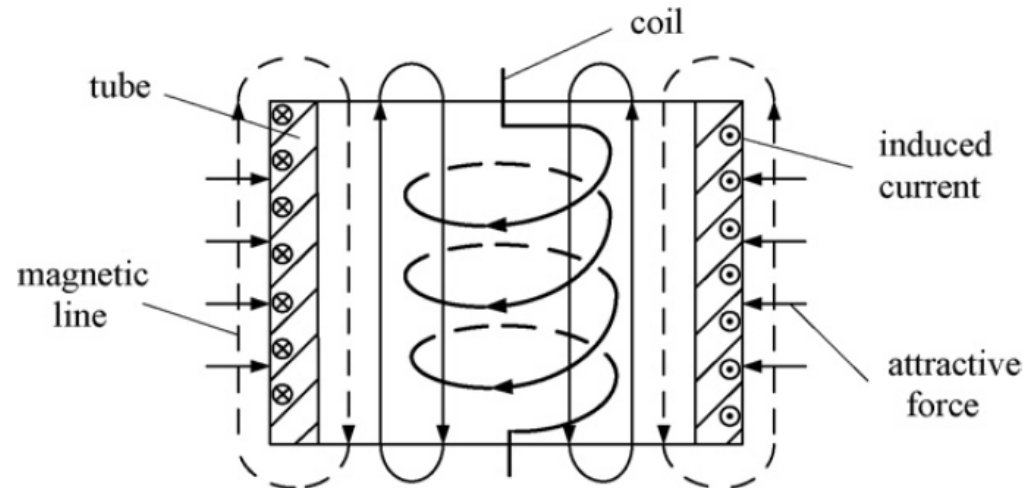

Fig. 2. Principle of electromagnetic attractive force.

Deng: Numerical simulation of magnetic flux and force in electromagnetic forming with attractive force

„[...] Accordingly, the improved discharge current which ascends slowly, descends quickly, and descends slowly is more suitable for the process of electromagnetic attractive force forming. [...]“

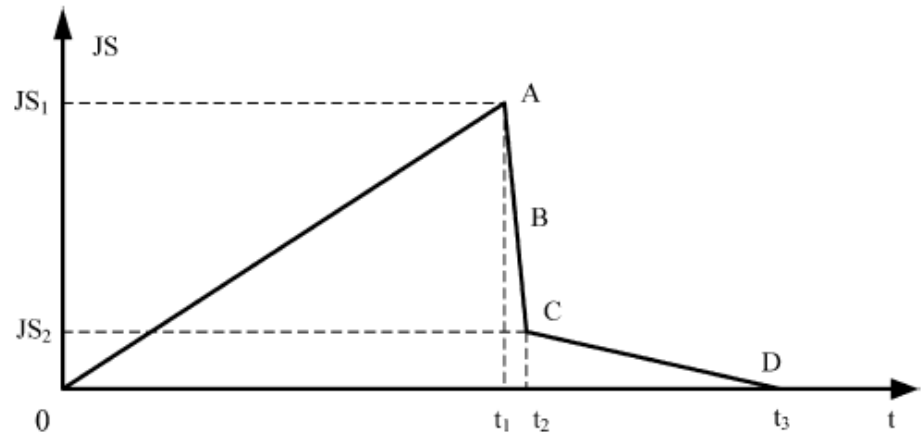

Fig. 7. Improved waveform of current density.

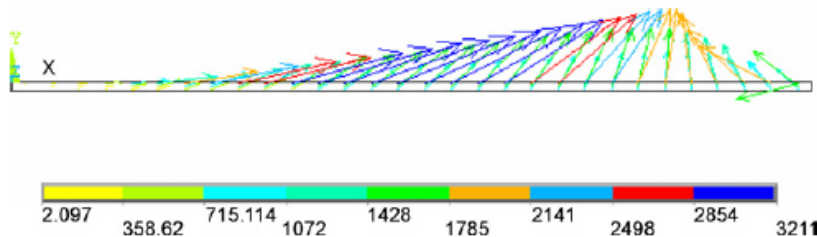

Fig. 11. Distribution of magnetic force vector at time $(t_1 + t_2)/2$.

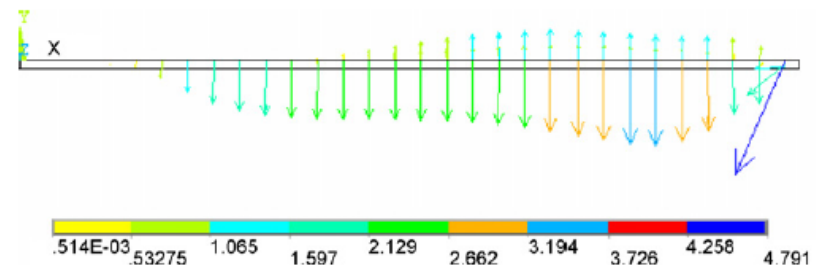

Fig. 12. Distribution of magnetic force vector at time t_3 .

Steingröver: Patent DE 196 02 951 C 2

Verfahren und Vorrichtung zum Aufweiten von Rohren oder rohrförmigen Teilen durch das Magnetfeld eines Stromimpulses

- Proposes negative magnetic pressure as a way to remove driver materials
- Uses a sine wave as current in coil

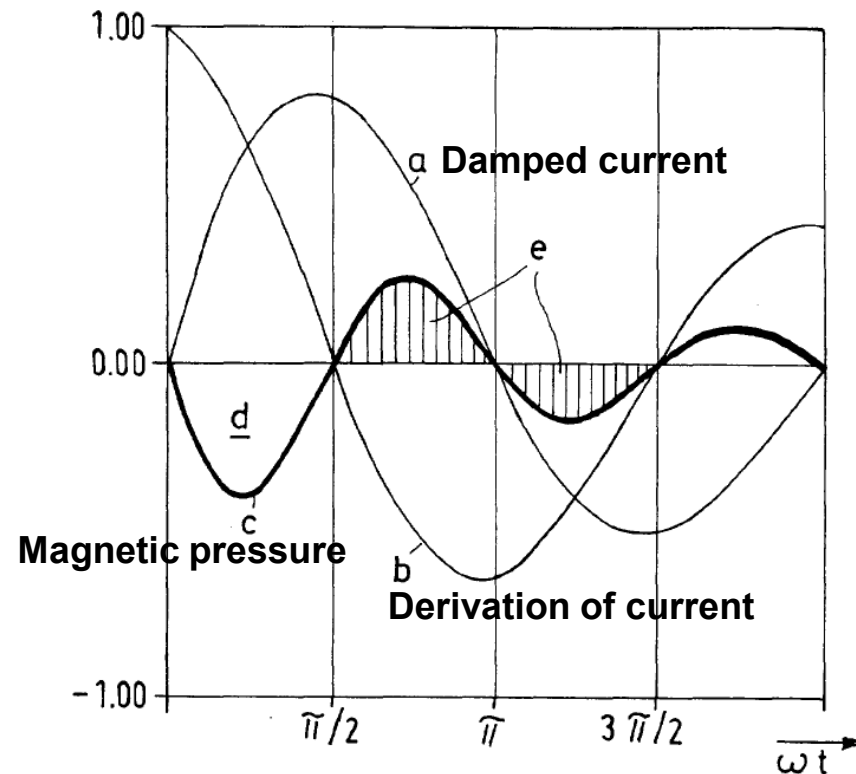
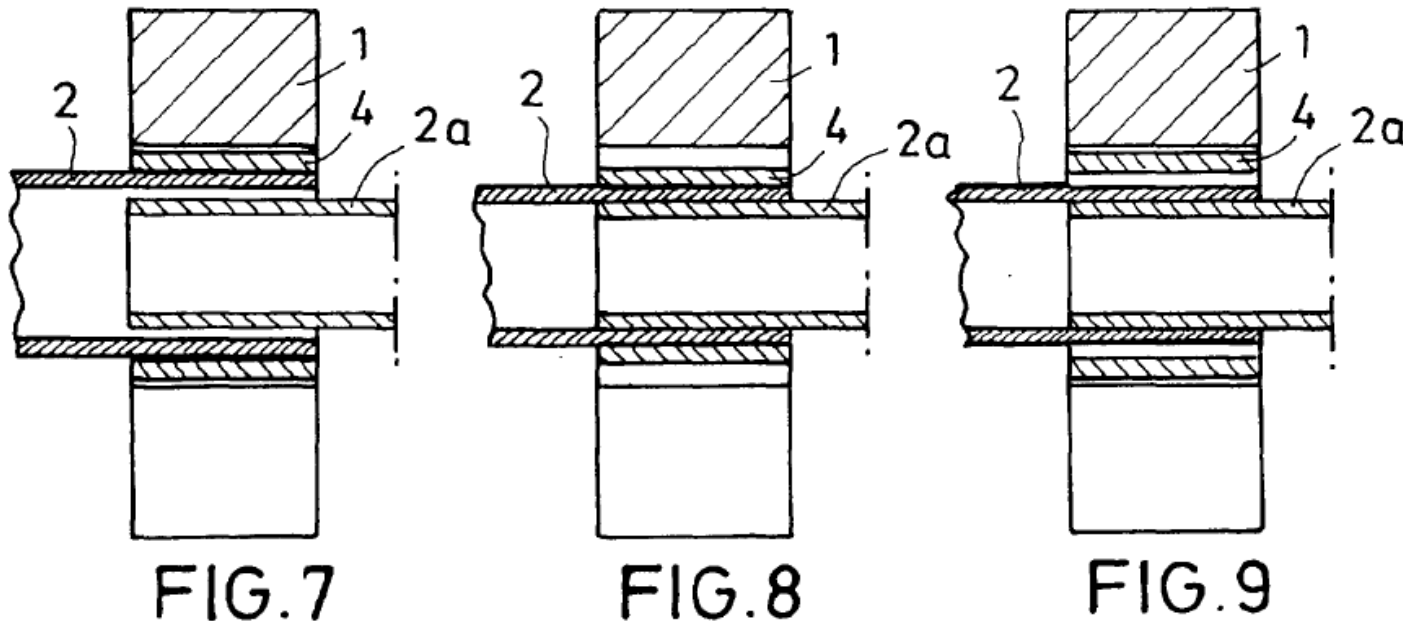

FIG.1

Steingröver:

Patent DE 196 02 951 C 2

Verfahren und Vorrichtung zum Aufweiten von Rohren oder rohrförmigen Teilen durch das Magnetfeld eines Stromimpulses



1 Coil

2 Outer part of workpiece

2a Inner part of workpiece

4 Driver ring

2. Transient vs. Time-Harmonic Calculation

Solution of differential equation

$$\dot{i} + \frac{R}{L} \cdot i = \frac{u_e(t)}{L} \quad (1)$$

Homogeneous solution

→ Right side of eq. (1) is set to zero

$$i_h = K \cdot e^{-\frac{t}{\tau}}, \quad \tau = \frac{L}{R}$$

Special solution

→ Formulation according to cosine-function of $u_e(t)$

$$i_p(t) = A \cdot \sin(\omega \cdot t) + B \cdot \cos(\omega \cdot t)$$

→ Differentiation and use in eq. (1) leads to special solution

Sum

$$i(t) = K \cdot e^{-\frac{t}{\tau}} + I_0 \cdot \sin(\omega \cdot t + \varphi_I)$$

$$I_0 = \sqrt{A^2 + B^2} \quad \varphi_I = \arctan\left(\frac{B}{A}\right)$$

$$A = \frac{U_0}{L} \cdot \frac{\omega \tau^2}{1 + (\omega \tau)^2}$$

$$B = \frac{U_0 \cdot R}{L^2} \cdot \frac{\tau^2}{1 + (\omega \tau)^2}$$