

Numerical Modelling of High Speed Blanking Considering Thermoviscoplastic Effects*

K. B. Sidhu, I. Peshekhodov, B.-A. Behrens

Institute of Metal Forming and Metal-Forming Machines (IFUM),
Leibniz University of Hannover, Germany

Abstract

To achieve the required specifications of the cut-edge profile of a blank, a time consuming trial and error procedures based on empirical information are utilized. However, the modern industry demands high quality product specifications in the shortest possible production time. Therefore, in order to predict the cut-edge profile and speed up the production process, it is essential to develop a reliable numerical model of the high speed blanking process which can predict the cut-edge profile of the blanks.

In this study, the Lagrangian based finite element (FE) approach was used to model large strain deformation that takes place in the shearzone during blanking. However, the large deformation is difficult to model using Lagrangian approach as it leads to a severe distortion of the FE mesh. Therefore, in order to overcome a premature termination of the analysis due to the mesh distortion, an adaptive remeshing and rezoning technique was developed. Furthermore, to model the ductile fracture, the discrete crack propagation method was implemented in the MSC.Marc®

Due to high speed of the cutting stamp, thermoviscoplastic material behaviour has to be taken into account. The Johnson-Cook plasticity model was used to model viscoplasticity. The results obtained from the FE analysis are presented in this paper.

Keywords

Blanking, Finite element method (FEM), Plasticity, Fracture

* This work is based on the results of GRK615 / B8; the authors would like to thank DFG for its financial support

1 Introduction

The blanking process is widely used for cutting sheet metal components in large quantities in a broad range of industries. Almost every sheet part that leaves the assembly line, either as a pre-formed piece or a finished part, undergoes blanking. During this process, the sheet is placed between the blankholder and the die, and a predefined blank shape is punched-out of the sheet with the cutting stamp. Due to the sharp stamp-edge, highly localised shear deformation takes place in the sheet leading to ductile fracture. Consequently, the cutting of sheet leads to a typical cut-edge profile of the blank which can be distinguished in four zones: rollover, shear edge, fracture and burr (Fig. 1). The quality of the cut-edge is determined based on the size of these zones, a good quality of the cut-edge implies maximum size of shear-edge and the minimum size of rollover, fracture zone and burr.

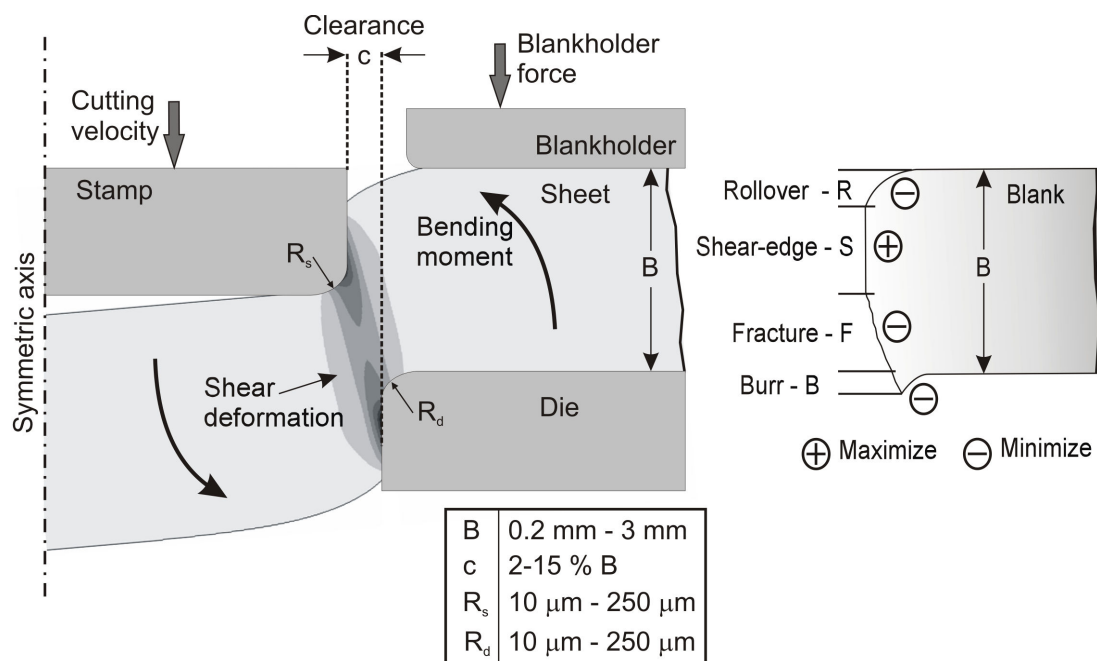

Figure 1: Blanking process (left) and a typical cut-edge profile (right)

The cut-edge profile is dependent on the process parameters and the material behaviour of the sheet metal. The process parameters include the clearance, cutting velocity, tool geometry, tool wear, kinematic of the press, geometry and sheet thickness of the component. The material properties of the sheet include strain rate and temperature dependent flow behaviour and grain size [1]. To achieve a desired quality of the cut-edge, usually time consuming trial and error procedures based on empirical knowledge are used. Therefore, a development of a reliable finite element model (FEM) of the blanking process is necessary in order to predict the cut-edge profile, and consequently, speed-up the development of the production process leading to the desired quality of the cut-edge.

At present no commercial finite element package capable of simulating blanking process with a required degree of accuracy is available. In order to accurately simulate blanking, commercial finite element software should be capable of implementing adaptive remeshing technique and discrete crack propagation in order to overcome large-localised

shear deformation and ductile fracture [2]. Furthermore, the thermoviscoplastic effects due to high speed of the cutting stamp should also be taken into account to model an industrial blanking process that is usually done with high stamp velocities.

Therefore, the main objective of this paper is to present a fundamental FEM model to simulate blanking by taking into account the characteristic extremely large and local elastoviscoplastic deformation, and eventually modelling of material separation due to ductile fracture.

2 Adaptive Remeshing

The cut-edge radius of the blanking tools is usually extremely small, generally of order 10 μm to 30 μm . This leads to a very large and localised shear deformation, especially in the proximate region of the tools cutting edge, causing a severe distortion of the finite element mesh in this region. Therefore, in order to overcome the problem of severe element distortion in blanking, an adaptive remeshing technique (figure 2) given by Rank et al. [3] was implemented MSC.Marc[®]. The use of an adaptive mesh keeps the number of elements to the minimum required and, consequently, significantly reduces the computing time and effort due to a considerable reduction in number of degrees of freedom (DOF).

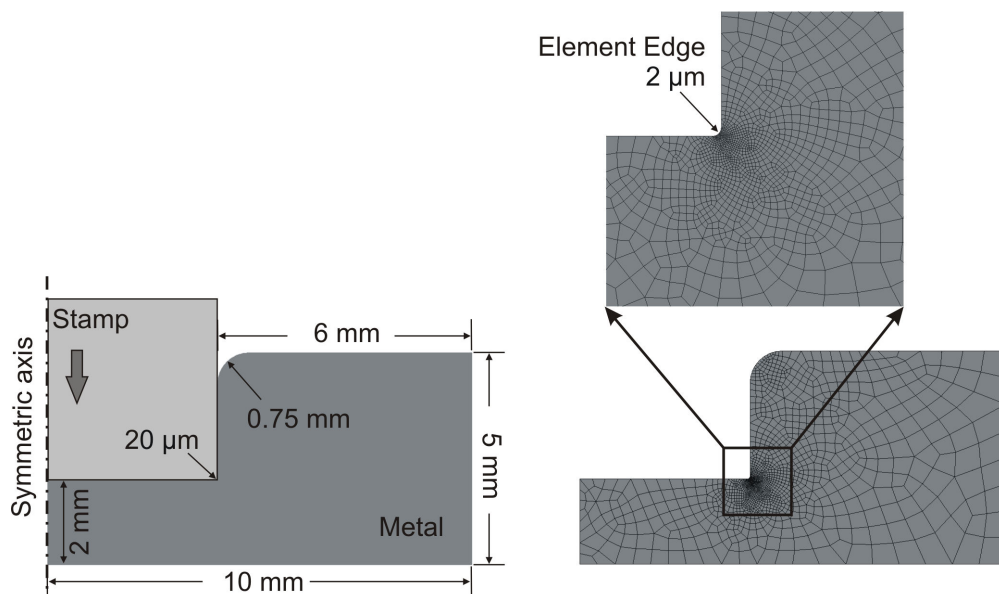

Figure 2: Adaptive mesh

In this study bi-linear, four-noded, isoparametric quadrilateral elements with four integration points were implemented for two dimensional modelling of sheet continuum. The constant dilatational elements are recommended for incompressible, large strain plasticity since the conventional elements causes volumetric locking due to over constraints for nearly incompressible behaviour. Therefore, the element type 10 was selected from MSC.Marc[®] elements library to model axi-symmetric of blanking process.

3 Modelling of Damage and Ductile Crack Propagation

In this paper, the uncoupled damage [4,5,6] was implemented in which mechanical properties are not influenced by damage laws. The damage parameter is computed based on an integral of stress function over equivalent plastic strains. This approach is easy to implement in a finite element code, however a drawback of this method is that it does not take in account the gradual decrease of stress carrying capacity of the material due to damage evolution. Therefore, in this paper a simple fracture criterion given by Oyane et al, as given in equation 1, was used as an indicator the crack initiation and propagation [6].

$$\int^{\bar{\varepsilon}_p} \left(1 + 3.9 \frac{\sigma_h}{\bar{\sigma}} \right) d\bar{\varepsilon}_p > C_r, \quad (1)$$

where $\frac{\sigma_h}{\bar{\sigma}}$ is the triaxiality which is hydrostatic pressure over equivalent (von Mises) stresses and C_r is the material dependent critical value.

In order to model the ductile crack propagation in blanking, the modified nodal release method [7, 8, 9] was implemented followed by rezoning of the state variables from the pervious increment to the current increment. In the modified nodal release technique, the nodes of an element near to the crack tip are moved in order to accommodate the crack extension as shown in figure 3. The advantage of this method is that it is possible to follow the predicted crack with only slight modification in the local mesh near to the crack tip.

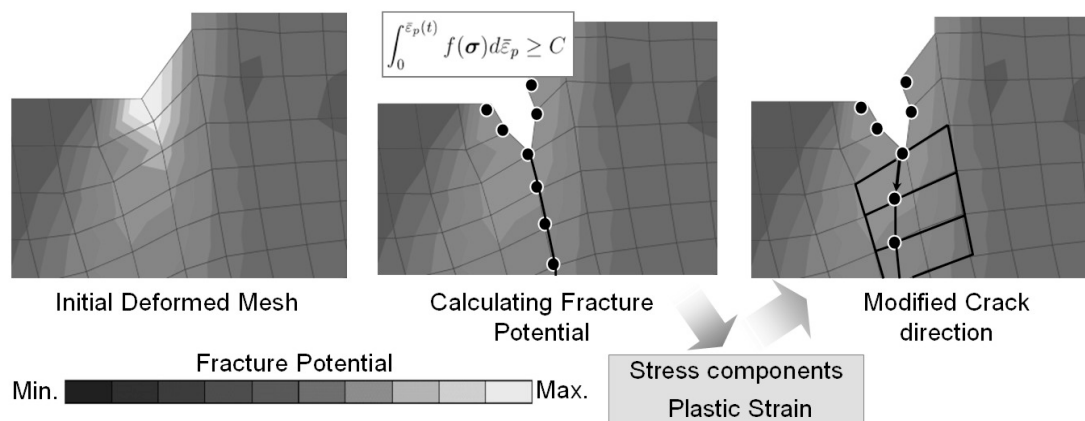

Figure 3: Implementation of crack interface using modified nodal release method with rezoning of state variables [7, 9]

4 State Variables Transfer

After the remeshing step, the state variables are transferred from the old mesh to the new mesh. The transfer of the state variables from the old mesh to the new mesh is also

known as rezoning. During rezoning, the values of the nodal variables are transferred from nodes of the old mesh to the new mesh, and the state variables at integration points are transferred from to the new integration points.

In this study the Inverse distance weighted method (IDW) [10] was implemented for rezoning of state variables. In IDW, the value at the new integration point or the node is interpolated from all the values at the integration points or the nodes of the old mesh that are specified in the patch, as shown in figure 4. The values at the new integration point or the node using the following equations:

$$R_i = \sqrt{(x_p - x_i)^2 + (y_p - y_i)^2},$$

$$SV_p = \frac{\sum_{i=1}^n SV_i}{\sum_{i=1}^n R_i^2} ; \text{ if } R_i \neq 0,$$

$$SV_p = SV_i ; \text{ if } R_i = 0,$$
(2)

where x_p , y_p are the coordinates of new point in current mesh, and x_i , y_i are the coordinates of points in pervious mesh. R_i is the radial distance between the two points. SV_p represents the state variable at the new point, and SV_i represents the state variable at the point in the pervious mesh.

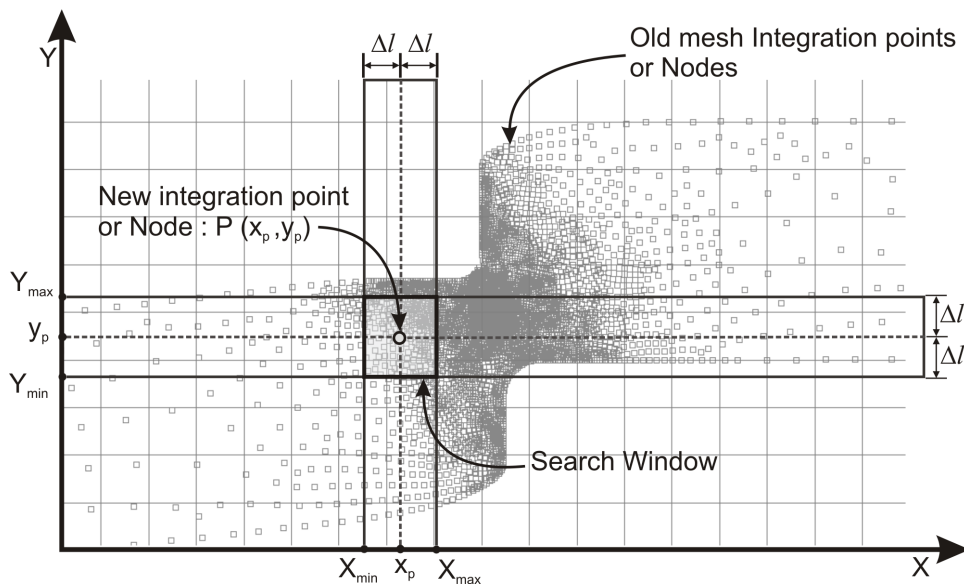

Figure 4: Rezoning of state variables using the Inverse distance weighted method

5 Johnson-Cook Viscoplasticity

It has been observed that the flow stresses of the metal increases as the strain rate increases and decreases as temperature increases [11]. The high stamp velocities used

in blanking performed in the industry lead to high strain rates and an increase in temperature due to plastic work dissipation in the shear zone of the sheet. Therefore, the increase in strain rate leads to viscous effects where as increase in temperature leads to thermal softening in the sheet. Hence, a temperature depended elastoviscoplastic behaviour should be taken into account to represent the sheet metal behaviour during high speed blanking.

The elastoviscoplastic model given by Johnson-Cook [12] was implemented to get an accurate representation of the strain rate and temperature dependency of material behaviour of sheet metal as given in the following equation:

$$\sigma_f = (A + B\varepsilon^n) \left(1 + C \ln \frac{\dot{\varepsilon}}{\dot{\varepsilon}_0} \right) (1 - T_\theta), \quad (3)$$

$$T_\theta = \begin{cases} 0 & T \leq T_R \\ \left(\frac{T - T_R}{T_{ml} - T_R} \right)^m & T_R < T < T_{ml} \\ 1 & T > T_{ml} \end{cases}$$

where A , B , C , n , m are material parameters, σ_f is the flow stresses (von Mises), $\dot{\varepsilon}$ is the actual strain rate, T is the actual temperature, $\dot{\varepsilon}_0$ is the initial strain rate, T_R is transition temperature, T_{ml} is the melting temperature. The transition temperature of a metal may vary from $T_R = 0.2 T_{ml}$ to $0.4 T_{ml}$ [13]. This equation shows that the thermal softening takes place once the temperature of the sheet becomes higher than transition temperature T_R . The material parameter used for Ck45N is shown in the following table.

A	B	C	n	m	T_{ml} [°C]	T_R [°C]
500	693	0.0114	0.36	1	1600	320

Table 1: Material parameters of Ck45N [14]

The heat generation due to plastic work dissipation is calculated by the following energy balance equation [15], and due to adiabatic nature of the process heat transfer to the surrounding and in the sheet is neglected.

$$\partial T = \frac{k \sigma_f}{\rho c_p} \dot{\varepsilon} \partial t, \quad (4)$$

where ∂T is the increase in temperature, ∂t is the infinitesimal time increment, k is the conversion factor and is assumed to be 0.95, ρ is the mass density, and c_p is the heat capacity.

6 Influence of Cutting Velocity on the Cut-Edge Profile

It has been experimentally observed that the cutting velocity has a significant influence on the cut-edge [16]. The size of shear-edge increases with an increase in the cutting velocity due to thermal softening of the sheet material. This thermal effect is an adiabatic process in which the heat is generated due to high strain rate; consequently, the kinetic energy is almost completely transferred into heat resulting in a sharp and localised increase in temperature of the sheet in a split second as shown in figure 5 the temperature increase at 80 % deformation of the sheet with respect to the original undeformed.

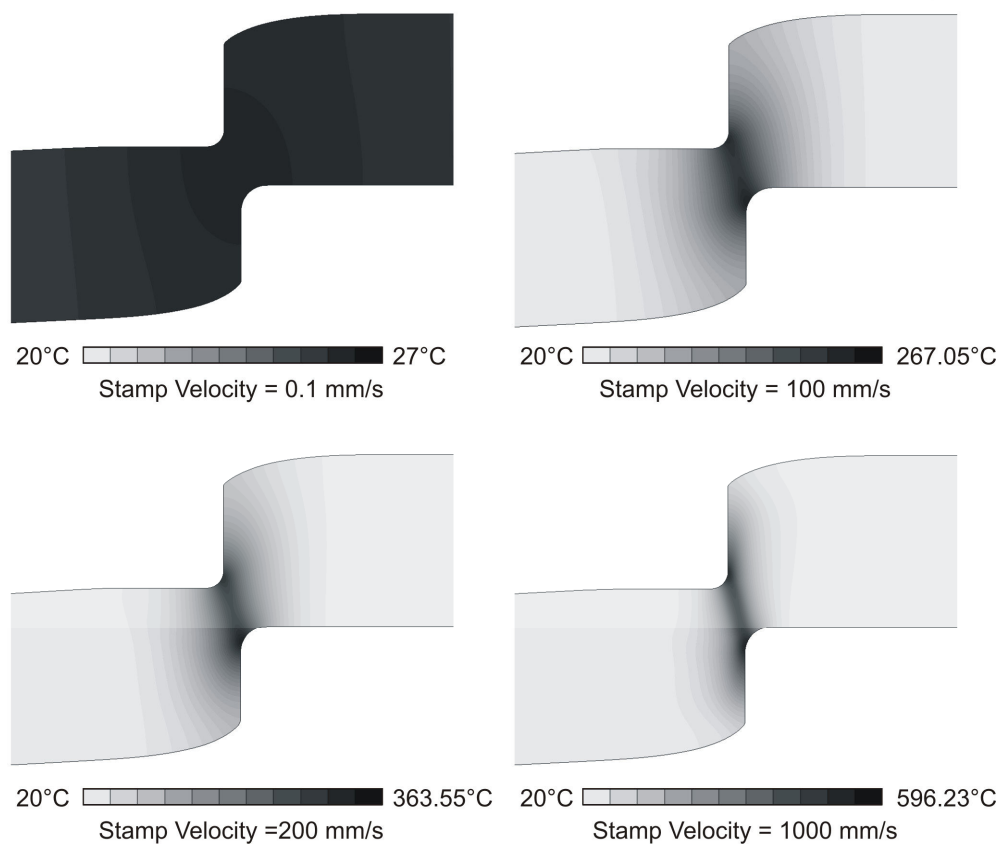

Figure 5: Increase in temperature with the increase in stamp velocity. The deformation shown is 80 % with respect to the original undeformed sheet.

As presented in Section 5, the thermal softening behaviour of the sheets takes place once the temperature of the sheet gets higher than transition temperature T_R and it is assumed to be 20 % of the melting temperature. Therefore, according to equation 3, as soon as heat generated due to plastic dissipation in sheet increases its temperature more than transition temperature, the term T_θ becomes non-zero. Consequently, it causes a decrease in the flow curve of the sheet metal. As shown in figure 6, the transition zone lies between the stamp velocity of 100 mm/s and 200 mm/s. In this zone, the temperature due to the heat generated becomes higher than the transition temperature. Therefore, as presented in figure 6, the von Mises stresses at 80 % deformation of the sheet increases due to the viscous effect caused by strain rates and reaches a peak and then starts

decreasing due to the thermal softening influence. Therefore, this implies that the shear edge first decreases with the increasing strain rate and after the transition zone it starts to increase again due to thermal softening of the sheet as shown in figure 6.

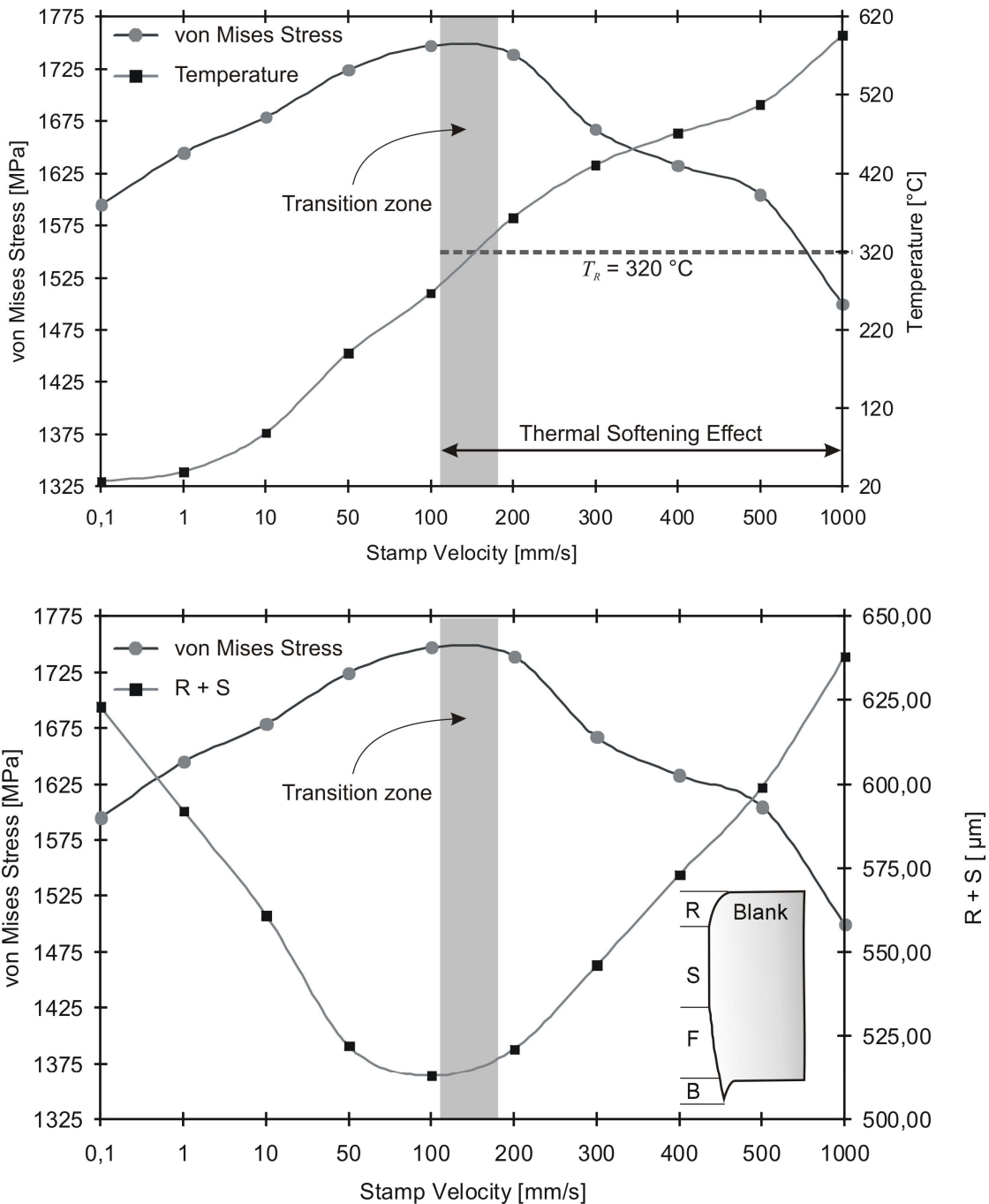

Figure 6: Influence on stamp velocity on the cut-edge profile

7 Conclusions

In this paper, a numerical model to simulate blanking and consequently predict the cut-edge profile of the blank was presented. An adaptive remeshing, rezoning and discrete crack propagation techniques were implemented in a commercial finite element software MSC.Marc[®]. The adaptive mesh based on Rank et al [3] provides a effective and robust mesh to capture a sharp edge of order 10 μm to 30 μm and at the same time keeps the number of elements to the minimum required and, thus, reducing the computational costs. Fracture criterion given by Oyane et el [6] gives relatively good results, however, it is necessary to develop a fracture criterion based on continuum damage mechanics. The elastoviscoplastic model given by Johnson-Cook [12] was implemented to get an accurate representation of the strain rate and temperature dependency of material behaviour. With the help of this model it is observed that the size of the shear-edge increases with the increase in the cutting velocity due to thermal softening of the sheet material. The thermal softening behaviour of the sheets takes place once the temperature of the sheet becomes higher then transition temperature T_R which is assumed to be 20 % of the melting temperature [13]. The prediction of rollover shape and the shear-edge can be predicted within the experimentally observed range for 0.1 mm clearance as shown in figure 7.

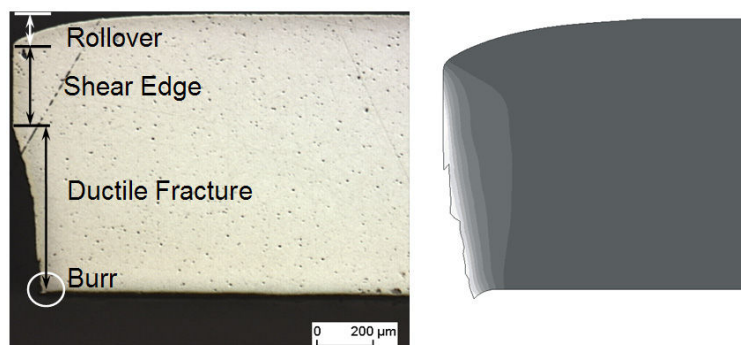

Figure 7: Comparison of the micrograph (left) with blanking simulation at 0.1 mm clearance and 50 mm/s stamp velocity

References

- [1] *H.-H. Schmuetsch*: Einflussgrößen auf das Schneidergebnis beim Scherschneiden von Feinblechen, Ph.D thesis, IFUM, University of Hannover, 1990.
- [2] *D. Brokken*: “Numerical modelling of ductile fracture in blanking”, Ph.D. thesis, Technische Universiteit Eindhoven, Netherlands, 1999.
- [3] *E. Rank, M. Schweingruber and M. Sommer*: Adaptive mesh generation and transformation of triangular to quadrilateral meshes, Communications on Numerical Methods in Engineering, 9 (1993), p. 121–129.
- [4] *F. A. McClintock*: A criterion for ductile fracture by growth of holes subjected to multi-axial stress-states. J. of App. Mechanics. Vol. 35 (1968), p. 33-39.
- [5] *J. R. Rice, D. M. Tracey*: On the ductile enlargement of voids in triaxial stress fields. J. of Mechanics and Phy. of Solids. Vol. 17 (1969), p. 201-217.
- [6] *M. Oyane, T. Sato, K. Okimoto, S. Shima*: Criteria for ductile fracture and their application, J. of Mech. Work. Tech. Vol. 4 (1980), p. 65-81.

- [7] *B.-A Behrens, K.B. Sidhu, O. Posse*: Different Approaches to Model the Material Separation during the Blanking Process using FEM, International Deep Drawing Research Group Conference (IDDRG '06), Porto, Portugal, June 2006.
- [8] *B.-A Behrens, K.B. Sidhu*: Finite Element Analysis of Nodal Release Approach to Model Ductile Fracture in Metal Sheets. XIV Conference Computer Methods in Materials Science, KomPlasTech '07, Zakopane, Poland, January 2007.
- [9] *B.-A Behrens, K.B. Sidhu*: Numerical Modeling and Analysis of Ductile Crack Propagation in Blanking Process Using Modified Nodal Release Method. 12th International Conference on Sheet Metal, SheMet '07, Palermo, Italy, April 2007.
- [10] *M. Dyduch, A.M. Habraken, S. Cescotto*: Automatic adaptive remeshing for numerical simulations of metalforming, *Comp. Meth. Appl. Mech. Engrg.* 101, 283–298, 1992.
- [11] *E. El-magd, C. Treppmann, M. Körthäuer*: Experimentelle und numerische Untersuchungen zum thermomechanischen Stoffverhalten. 'Hochgeschwindigkeitsspanen metallischer Werkstoffe', PZH, Universität Hannover, January 2004.
- [12] *G. R. Johnson and W.H. Cook*: A constitutive model and data for metals subjected to large strains, high strain rates and high temperatures. Proceedings of the seventh international symposium on ballistics. Hague, Netherlands. 1983.
- [13] *C. Treppmann*: Fließverhalten metallischer Werkstoffe bei Hochgeschwindigkeitsbeanspruchung Dr.-Ing. Dissertation, RWTH Aachen, 2001 .
- [14] *K. Kalisch*: FEM-Beschreibung der Einflüsse der Werkzeuggeometrie bei der Hochgeschwindigkeitszerspannung, Universität der Bundeswehr Hamburg, Germany. 2006.
- [15] *L.W. Meyer, T. Halle*: Ermittlung von Werkstoffkenndaten für die numerische Simulation des Hochgeschwindigkeitsspanens. 'Hochgeschwindigkeitsspanen metallischer Werkstoffe', PZH, Universität Hannover, January 2004.
- [16] *M. Grünbaum, J. Breitling, T. Altan*: Influence of high cutting speeds on the quality of the blanked parts. Report No. ERC/NSM - S-96-19, NSF Engineering Research Center for Net Shape Manufacturing, Ohio State University. May 1996.